





REPAIR HINTS

[bg]	Съвети за ремонт	2
[hr]	Savjeti za popravak	31
[cs]	Poznámky k opravě	60
[da]	Tip til reparation	89
[nl]	Reparatie informatie	118
[en]	Repair hints	147
[et]	Remonditeave	176
[fi]	Korjausvinkit	205
[fr]	Conseils de réparation	234
[de]	Reparatur Hinweise	263
[el]	Υποδείξεις επισκευής	292
[hu]	Javítási útmutató	321
[it]	Consigli di riparazione	350
[lv]	Informācija par remontu	379
[lt]	Informacija apie remontą	408
[no]	Reparasjonstips	437
[pl]	Wskazówki naprawy	466
[pt]	Dicas de resolução	495
[ro]	Indicii pentru reparații	524
[sk]	Poznámky k opravám	553
[sl]	Nasveti za popravilo	582
[es]	Consejos de reparación	611
[sv]	Reparationsinformation	640
[tr]	Onarım İpuçları	669

Съвети за ремонт - Fridge-freezer

 Относно този документ	3
1.1 Важна информация.....	3
1.1.1 Цел.....	3
1.2 Обяснение на символите.....	3
1.2.1 Нива на опасност.....	3
1.2.2 Символи за опасност.....	3
1.2.3 Структура на предупрежденията.....	4
1.2.4 Общи символи.....	4
 Безопасност	5
2.1 Общи инструкции за безопасност.....	5
2.1.1 Всички домашни уреди.....	5
 Инструменти и помощни средства	6
 Ремонт	7
4.1 Смяна на уплътнителя на вратата.....	7
4.1.1 Сваляне на уплътнителя на вратата.....	7
4.1.2 Монтиране на уплътнителя на вратата.....	7
4.2 Смяна на дръжката на вратата.....	10
4.2.1 Изваждане на дръжката на вратата.....	10
4.2.2 Монтиране на дръжката на вратата.....	10
4.3 Смяна на горната панта на вратата.....	11
4.3.1 Сваляне на горната панта на вратата.....	11
4.3.2 Монтиране на горната панта на вратата.....	12
4.4 Смяна на горната панта на вратата (врата с дисплей).....	13
4.4.1 Сваляне на горната панта на вратата.....	13
4.4.2 Монтиране на горната панта на вратата.....	14
4.5 Смяна на средната панта на вратата.....	15
4.5.1 Сваляне на средната панта на вратата.....	15
4.5.2 Монтиране на средната панта на вратата.....	15
4.6 Смяна на долната панта на вратата.....	16
4.6.1 Сваляне на долната панта на вратата.....	16
4.6.2 Монтиране на долната панта на вратата.....	16
4.7 Смяна на рафта.....	17
4.7.1 Изваждане на рафта.....	17
4.7.2 Монтиране на рафта.....	17

4.8 Смяна на табличката за бутилки.....	18
4.8.1 Сваляне на табличката за бутилки.....	18
4.8.2 Монтиране на табличката за бутилки.....	18
4.9 Смяна на стелажа на вратата.....	19
4.9.1 Изваждане на стелажа на вратата.....	19
4.9.2 Монтиране на стелажа на вратата.....	19
4.10 Смяна на регулируемия стелаж на вратата.....	20
4.10.1 Сваляне на регулируемия стелаж на вратата.....	20
4.10.2 Монтиране на регулируемия стелаж на вратата.....	20
4.11 Смяна на контейнера за замразени хранителни продукти.....	21
4.11.1 Изваждане на контейнера за замразени хранителни продукти.....	21
4.11.2 Монтиране на контейнера за замразени хранителни продукти.....	21
4.12 Смяна на контейнера.....	22
4.12.1 Изваждане на контейнера.....	22
4.12.2 Монтиране на контейнера.....	22
4.13 Смяна на разтегателния контейнер.....	23
4.13.1 Изваждане на разтегателния контейнер.....	23
4.13.2 Монтиране на разтегателния контейнер.....	23
4.14 Смяна на LED спот лампата.....	24
4.14.1 Сваляне на LED спот лампата.....	24
4.14.2 Монтиране на LED спот лампата.....	24
4.15 Смяна на LED осветлението отгоре.....	25
4.15.1 Сваляне на LED осветлението.....	25
4.15.2 Монтиране на LED осветлението отгоре.....	26
4.16 Смяна на LED светлината на страничната лента.....	27
4.16.1 Сваляне на LED светлината на страничната лента.....	27
4.16.2 Монтиране на LED светлината на страничната лента.....	28
4.17 Смяна на LED спот лампата.....	29
4.17.1 Сваляне на LED спот лампата.....	29
4.17.2 Монтиране на LED спот лампата.....	30

i Относно този документ

1.1 Важна информация

1.1.1 Цел

Тези съвети за ремонт помагат на потребителя да ремонтира сам уреди в съответствие с регламента за екологосъобразно проектиране на уредите (от 03.2021 г.).

Те съдържат информация как да сменят определени резервни части, включително предупреждения и рискове.

Ако имате някакви въпроси, моля свържете се с нашия отдел за обслужване на клиенти. Ние носим отговорност за щети, само ако съветите за ремонт са спазени правилно.

1.2 Обяснение на символите

1.2.1 Нива на опасност

Предупредителните нива се състоят от символ и сигнална дума. Сигналната дума показва сериозността на опасността.





Ниво на предупреждение	Значение
 ОПАСНОСТ	Неспазването на предупредителното съобщение ще доведе до смърт или сериозни наранявания.
 ПРЕДУПРЕЖДЕНИЕ	Неспазването на предупредителното съобщение може да доведе до смърт или сериозни наранявания.
 ВНИМАТЕЛНО	Неспазването на предупредителното съобщение може да доведе до леки наранявания.
ВНИМАНИЕ!	Неспазването на предупредителното съобщение може да доведе до имуществени щети.

Таблица 1: Нива на опасност

1.2.2 Символи за опасност

Символите за опасност са символични изображения, които дават индикация за вида опасност.

В този документ се използват следните символи за опасност:

Символ за опасност	Значение
	Общо предупредително съобщение
	Опасност от електрическо напрежение
	Риск от експлозия
	Опасност от порязвания

i Относно този документ





Символ за опасност	Значение
	Опасност от премазване
	Опасност от горещи повърхности
	Опасност от силно магнитно поле
	Опасност от нейонизиращо лъчение

Таблица 2: Символи за опасност

1.2.3 Структура на предупрежденията

Предупрежденията в този документ имат стандартизиран външен вид и стандартизирана структура.

	<p>ОПАСНОСТ</p> <p>Вид и източник на опасността! Възможни последици от игнориране на опасността/предупреждението.</p> <ul style="list-style-type: none"> ▶ Мерки и забрани за предотвратяване на опасността.
--	--

Следният пример показва предупреждение, което уведомява за токов удар, предизвикан от части под напрежение. Споменава се мярката за избягване на опасността.

	<p>ОПАСНОСТ</p> <p>Риск от токов удар поради части под напрежение! Смърт от токов удар</p> <ul style="list-style-type: none"> ▶ Изключете уредите от електрическото захранване поне 60 секунди преди започване на ремонта.
--	--

1.2.4 Общи символи

В този документ се използват следните общи символи:







Общ символ	Значение
	Идентифициране на специален съвет (текст и/или графика)
	Идентифициране на прост съвет (само текст)
	Идентифициране на връзка към видео урок
	Идентифициране на необходимите инструменти
	Идентифициране на необходимите предварителни условия
	Идентифициране на условие (ако ..., тогава ...)
	Идентифициране на резултат
Старт	Идентифициране на ключ или бутон
[00123456]	Идентифициране на каталожен номер
Статус	Идентифициране на показания текст/прозорец (на дисплея на уреда)

Таблица 3: Общи символи

2.1 Общи инструкции за безопасност

2.1.1 Всички домашни уреди

Риск от токов удар поради части под напрежение!

- Грешки при ремонти, включващи електрически компоненти, могат да доведат до токов удар!
- Разкачете уреда от електрическата мрежа за поне 60 секунди, преди да започнете работа.
- След ремонта трябва да се извърши проверка за безопасност съгласно VDE 0701 или в съответствие със специфичните за страната разпоредби.

Риск от нараняване от остри ръбове!

- Носете предпазни ръкавици.

Риск от премазване по време на ремонт, поддръжка, отстраняване на неизправности и сервиз поради тежки и движещи се компоненти

- Носете защитни обувки.
- Закрепете тежките компоненти, така че да не паднат.
- Не позволявайте контакт на части от тялото с движещи се компоненти.

Риск за безопасността/функцията на уреда!

- Използвайте само оригинални резервни части.

Риск от повреда на електростатично чувствителни компоненти (ESD)!

- Не докосвайте модулите, включително връзки и проводникови пътища.

Инструменти и помощни средства

посочване	Подробности	Изображения
Защитна кърпа [00342013]	60 см x 50 см	
Плоска отвертка	Връх 2,4 мм x 0,4 мм x 60 мм, в комплекта [00341820]	
Специален инструмент [00342180]		
Смукателна чаша [00342224]	Ø50 мм	
Накрайник Torx TX20 [00340865]	6,3 мм (1/4")	
Плоска отвертка	Връх 10 мм x 1,6 мм x 200 мм	

4.1 Смяна на уплътнителя на вратата

Изискване:

- ✔ Вратата е отворена.

4.1.1 Сваляне на уплътнителя на вратата

1. Освободете уплътнителя на вратата от жлеба отляво и отдясно.





2. Извадете уплътнителя на вратата от жлеба.



- ➡ Уплътнителят на вратата е свален.

4.1.2 Монтиране на уплътнителя на вратата

	Дебелината на новия уплътнител на вратата може леко да се отличава от тази на стария уплътнител. Това няма да повлияе на начина на затваряне и нейната работа в дългосрочен план.
	Ако вашият уред има регулируеми панти или приставки за панти, можете да оптимизирате начина на затваряне по-късно.
	Малките странични отвори в уплътнителя на вратата са функционални (необходими за вентилация). Те не са производствени грешки.

1. Проверете жлеба на уплътнителя за повреди.

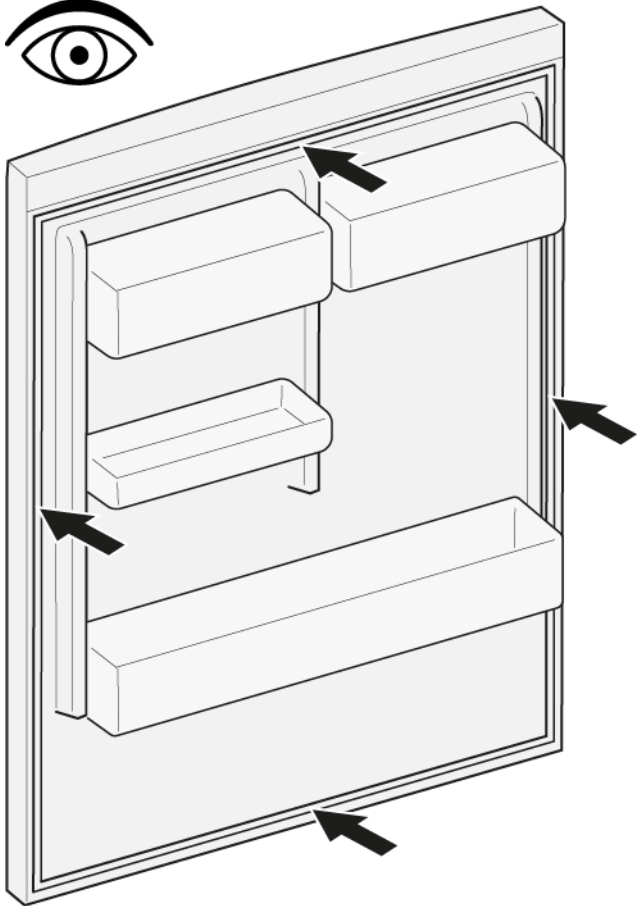

4. Натиснете ъглите на уплътнителя отгоре и отдолу към жлеба.

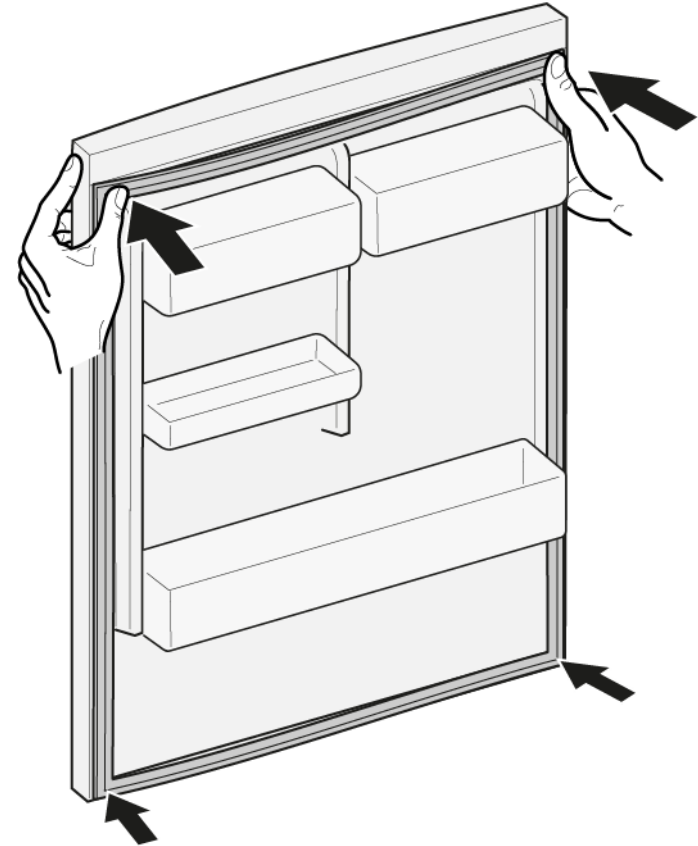

2.  Ако жлебът на уплътнителя е повреден:
- Свържете се с отдела за обслужване на клиенти.

3.  Леката деформация на уплътнителя на вратата е нормална и не засяга неговата функция. Препоръчително е да изправите уплътнителя на вратата, преди да го поставите в уреда.

Загрейте уплътнителя на вратата със сешоар или гореща вода и променете формата му.



5. Постепенно вкарайте с натискане целия уплътнител в жлеба.





 Уплътнителят на вратата е монтиран.

4.2 Смяна на дръжката на вратата

Специални инструменти:

-  Накрайник Torx TX20 6,3 мм (1/4") [00340865]
-  Плоска отвертка Врѝх 10 мм x 1,6 мм x 200 мм

Изискване:

-  Уредѝт е изключен от захранването.
-  Вратата е отворена.

4.2.1 Изваждане на дръжката на вратата

- ▶ 1. Свалете двете капачки на винтовете (1).
- ▶ 2. Развийте двата винта (2).
- ▶ 3. Свалете дръжката на вратата (3).

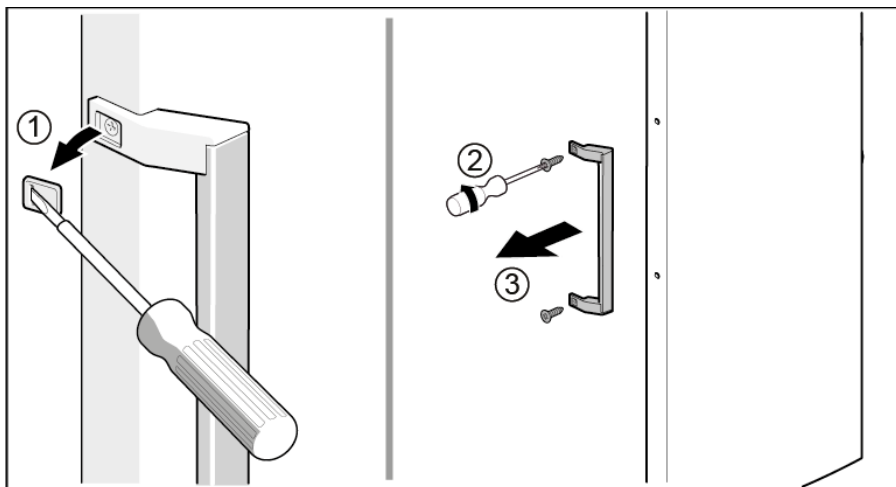

 Дръжката на вратата е свалена.



Дръжката на втората врата може да бъде свалена по същия начин.

4.2.2 Монтиране на дръжката на вратата

- ▶ Монтирайте в обратен ред.

4.3 Смяна на горната панта на вратата

Специални инструменти:

 Накрайник Torx TX20 6,3 мм (1/4") [00340865]

	<p>⚠ ПРЕДУПРЕЖДЕНИЕ</p> <p>Тежки, обемисти уреди! Травми на гърба и мускулите</p> <ul style="list-style-type: none"> ▶ Операцията по отстраняване на вратите на уреда трябва да се извършва само от обучени специалисти. ▶ За преместването на уреда са необходими двама души. ▶ Използвайте само подходящи инструменти и оборудване.
--	--



	<p>⚠ ВНИМАТЕЛНО</p> <p>Остри ръбове! Наранявания от порязване</p> <ul style="list-style-type: none"> ▶ Носете предпазни ръкавици.
--	--

	<p>⚠ ПРЕДУПРЕЖДЕНИЕ</p> <p>Приплъзване на наклонени уреди! Костни фрактури/наранявания от премазване</p> <ul style="list-style-type: none"> ▶ Укрепете уредите срещу приплъзване.
--	--

	<p>⚠ ВНИМАТЕЛНО</p> <p>Риск от падащи части поради разхлабени винтове! Нараняване поради падащи части.</p> <ul style="list-style-type: none"> ▶ Закрепете компонента, така че да не падне.
---	---

	<p>ВНИМАНИЕ!</p> <p>Риск от падащи части поради разхлабени винтове! Повреда на други части на уреда или в дома на клиента, напр. дъното.</p> <ul style="list-style-type: none"> ▶ Закрепете компонента, така че да не падне.
--	---

Изискване:

-  Уредът е изключен от захранването.
-  Вътрешните фитинги на уреда са отстранени.

4.3.1 Сваляне на горната панта на вратата

1. Поставете уреда легнал на задната си страна.

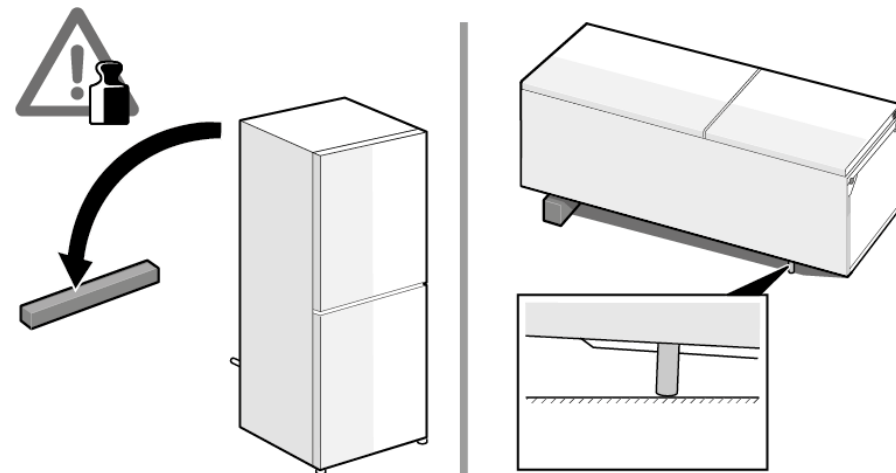

2. 1. Натиснете капачето на горната панта от двете страни (1).
2. Извадете капачето на горната панта (2).
3. Завъртете капачето на пантата (3).
4. Свалете капачето на горната панта (4).
5. Развийте двата винта (5).
6. Свалете горната панта (6)/

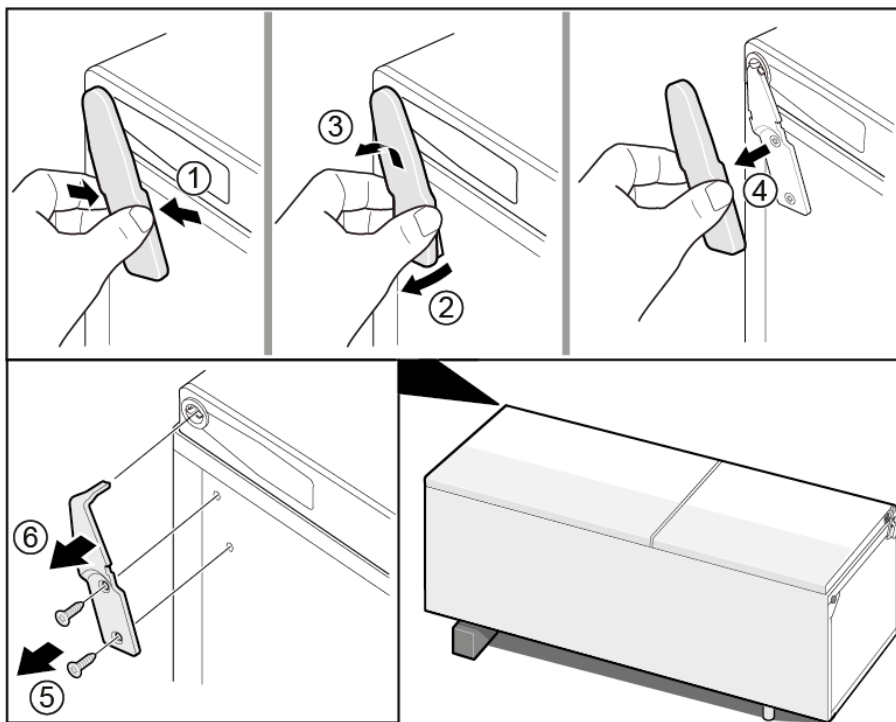

➡ Горната панта е свалена.

4.3.2 Монтиране на горната панта на вратата

- ▶ Монтирайте в обратен ред.

4.4 Смяна на горната панта на вратата (врата с дисплей)

Специални инструменти:

 Накрайник Torx TX20 6,3 мм (1/4") [00340865]

	⚠ ПРЕДУПРЕЖДЕНИЕ
	<p>Тежки, обемисти уреди! Травми на гърба и мускулите</p> <ul style="list-style-type: none"> ▶ Операцията по отстраняване на вратите на уреда трябва да се извършва само от обучени специалисти. ▶ За преместването на уреда са необходими двама души. ▶ Използвайте само подходящи инструменти и оборудване.

	⚠ ВНИМАТЕЛНО
	<p>Остри ръбове! Наранявания от порязване</p> <ul style="list-style-type: none"> ▶ Носете предпазни ръкавици.

	⚠ ПРЕДУПРЕЖДЕНИЕ
	<p>Приплъзване на наклонени уреди! Костни фрактури/наранявания от премазване</p> <ul style="list-style-type: none"> ▶ Укрепете уредите срещу приплъзване.



	⚠ ВНИМАТЕЛНО
	<p>Риск от падащи части поради разхлабени винтове! Нараняване поради падащи части.</p> <ul style="list-style-type: none"> ▶ Закрепете компонента, така че да не падне.

	ВНИМАНИЕ!
	<p>Риск от падащи части поради разхлабени винтове! Повреда на други части на уреда или в дома на клиента, напр. дъното.</p> <ul style="list-style-type: none"> ▶ Закрепете компонента, така че да не падне.

	⚠ ОПАСНОСТ
	<p>Риск от токов удар поради части под напрежение! Опасност за живота от токов удар в случай на неправилен ремонт</p> <ul style="list-style-type: none"> ▶ Електрическите части трябва да се ремонтират от квалифицирани електротехници. ▶ След ремонта трябва да се извърши проверка за безопасност съгласно VDE 0701 или в съответствие със специфичните за страната разпоредби.

	⚠ ОПАСНОСТ
	<p>Риск от токов удар поради части под напрежение! Смърт от токов удар</p> <ul style="list-style-type: none"> ▶ Изключете уредите от електрическото захранване поне 60 секунди преди започване на ремонта.

Изискване:

-  Уредът е изключен от захранването.
-  Вътрешните фитинги на уреда са отстранени.

4.4.1 Сваляне на горната панта на вратата

1. Поставете уреда легнал на задната си страна.

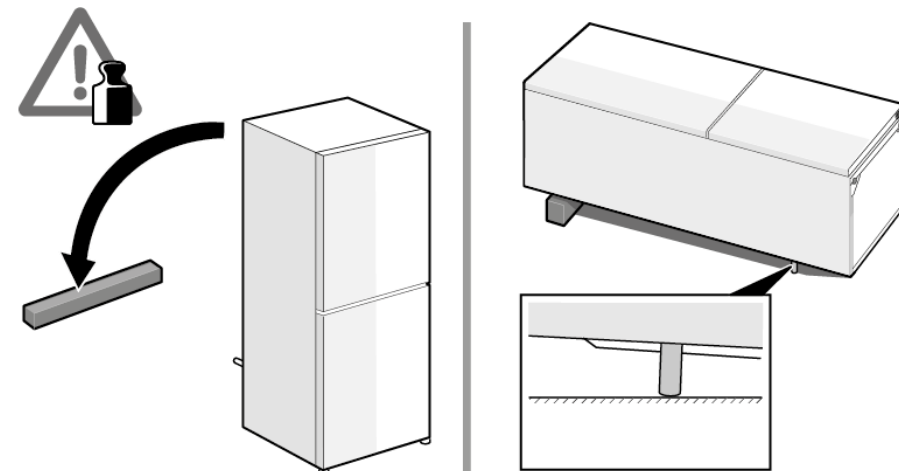

2. 1. Свалете капачето на горната панта (1).
2. Свалете капака на кабелната кутия (2).
3. Изключете електрическата връзка (3).
4. Развийте винта за заземяващата връзка (4).
5. Свалете кабелната защита (5).
6. Развийте винта (6).

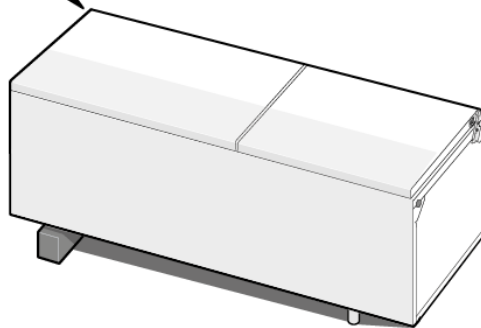
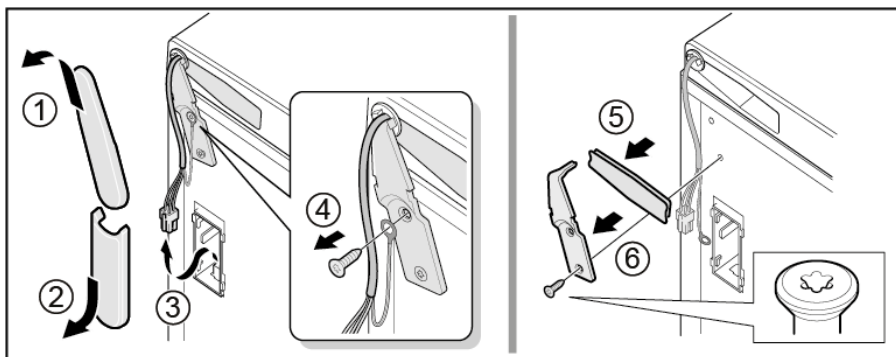

 Горната панта е свалена.

4.4.2 Монтиране на горната панта на вратата

- ▶ Монтирайте в обратен ред.

4.5 Смяна на средната панта на вратата

Специални инструменти:

 Накрайник Torx TX20 6,3 мм (1/4") [00340865]

	⚠ ПРЕДУПРЕЖДЕНИЕ
	<p>Тежки, обемисти уреди! Травми на гърба и мускулите</p> <ul style="list-style-type: none"> ▶ Операцията по отстраняване на вратите на уреда трябва да се извършва само от обучени специалисти. ▶ За преместването на уреда са необходими двама души. ▶ Използвайте само подходящи инструменти и оборудване.



	⚠ ВНИМАТЕЛНО
	<p>Остри ръбове! Наранявания от порязване</p> <ul style="list-style-type: none"> ▶ Носете предпазни ръкавици.

	⚠ ПРЕДУПРЕЖДЕНИЕ
	<p>Приплъзване на наклонени уреди! Костни фрактури/наранявания от премазване</p> <ul style="list-style-type: none"> ▶ Укрепете уредите срещу приплъзване.

	⚠ ВНИМАТЕЛНО
	<p>Риск от падащи части поради разхлабени винтове! Нараняване поради падащи части.</p> <ul style="list-style-type: none"> ▶ Закрепете компонента, така че да не падне.

	ВНИМАНИЕ!
	<p>Риск от падащи части поради разхлабени винтове! Повреда на други части на уреда или в дома на клиента, напр. дъното.</p> <ul style="list-style-type: none"> ▶ Закрепете компонента, така че да не падне.

Изискване:

-  Уредът е изключен от захранването.
-  Вътрешните фитинги на уреда са отстранени.
-  Горната панта на вратата е свалена.

4.5.1 Сваляне на средната панта на вратата

- ▶ 1. Свалете вратата на хладилното отделение (1).
- ▶ 2. Развийте двата винта (2).
- ▶ 3. Свалете средната панта (3).

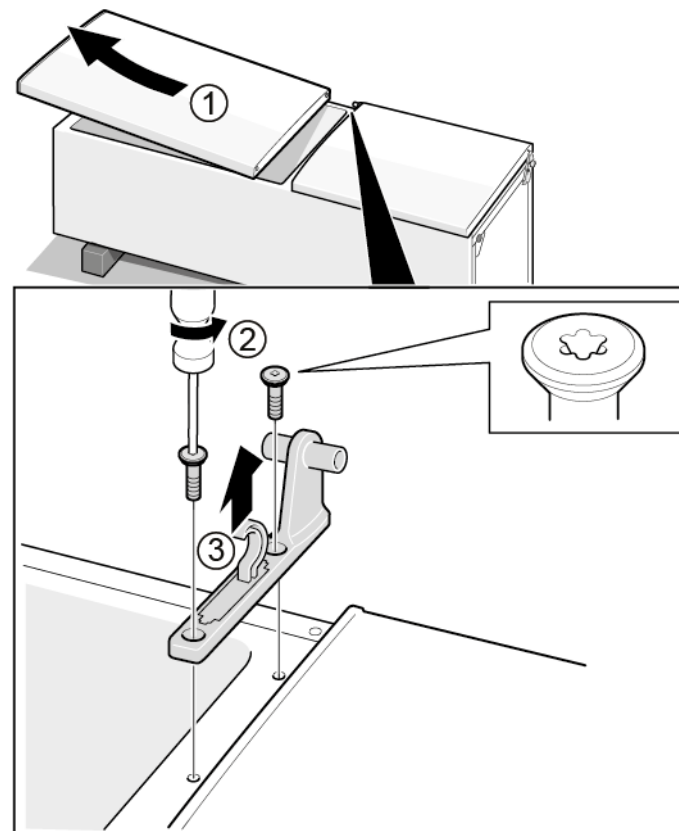

 Средната панта е свалена.

4.5.2 Монтиране на средната панта на вратата

- ▶ Монтирайте в обратен ред.

4.6 Смяна на долната панта на вратата

Специални инструменти:

 Накрайник Torx TX20 6,3 мм (1/4") [00340865]

	<p>⚠ ПРЕДУПРЕЖДЕНИЕ</p> <p>Тежки, обемисти уреди! Травми на гърба и мускулите</p> <ul style="list-style-type: none"> ▶ Операцията по отстраняване на вратите на уреда трябва да се извършва само от обучени специалисти. ▶ За преместването на уреда са необходими двама души. ▶ Използвайте само подходящи инструменти и оборудване.
--	--



	<p>⚠ ВНИМАТЕЛНО</p> <p>Остри ръбове! Наранявания от порязване</p> <ul style="list-style-type: none"> ▶ Носете предпазни ръкавици.
--	--

	<p>⚠ ПРЕДУПРЕЖДЕНИЕ</p> <p>Приплъзване на наклонени уреди! Костни фрактури/наранявания от премазване</p> <ul style="list-style-type: none"> ▶ Укрепете уредите срещу приплъзване.
--	--

	<p>⚠ ВНИМАТЕЛНО</p> <p>Риск от падащи части поради разхлабени винтове! Нараняване поради падащи части.</p> <ul style="list-style-type: none"> ▶ Закрепете компонента, така че да не падне.
---	---

	<p>ВНИМАНИЕ!</p> <p>Риск от падащи части поради разхлабени винтове! Повреда на други части на уреда или в дома на клиента, напр. дъното.</p> <ul style="list-style-type: none"> ▶ Закрепете компонента, така че да не падне.
--	---

Изискване:

-  Уредът е изключен от захранването.
-  Вътрешните фитинги на уреда са отстранени.
-  Горната панта е свалена.

-  Средната панта е свалена.

4.6.1 Сваляне на долната панта на вратата

- ▶ 1. Свалете вратата на фризерното отделение (1).
- ▶ 2. Развийте винта (2).
- ▶ 3. Извъртете долната панта навън (3).
- ▶ 4. Свалете долната панта (4).

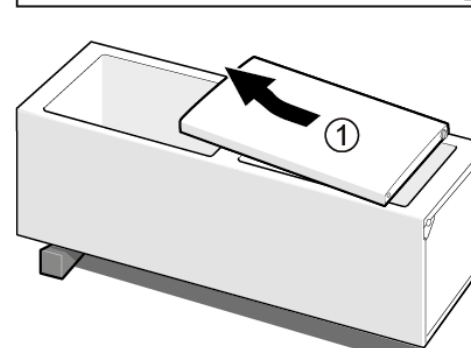
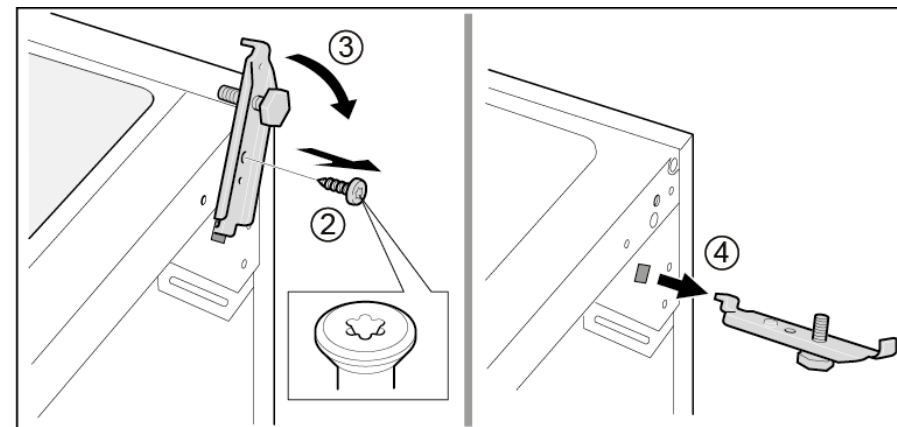

-  Долната панта на вратата е свалена.

4.6.2 Монтиране на долната панта на вратата

- ▶ Монтирайте в обратен ред.

4.7 Смяна на рафта

Изискване:

- ✔ Вратата е отворена.

4.7.1 Изваждане на рафта

- ▶ Издърпайте рафта.

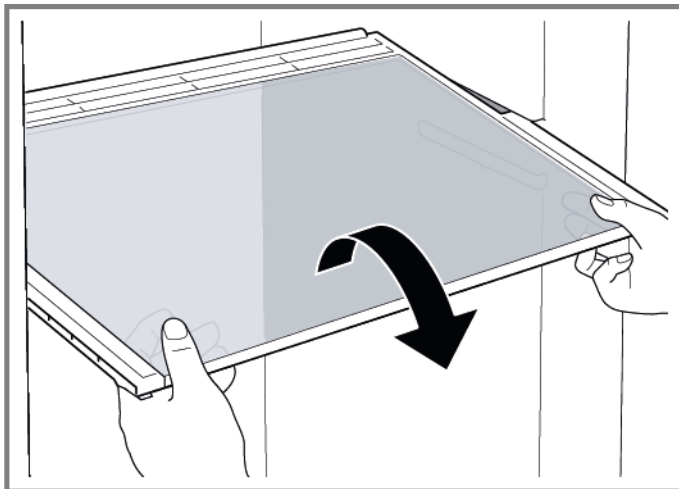

- ➡ Рафтът е свален.

4.7.2 Монтиране на рафта

- ▶ Монтирайте в обратен ред.

4.8 Смяна на табличката за бутилки

Изискване:

- ✔ Вратата е отворена.

4.8.1 Сваляне на табличката за бутилки

- ▶ Издърпайте табличката за бутилки.

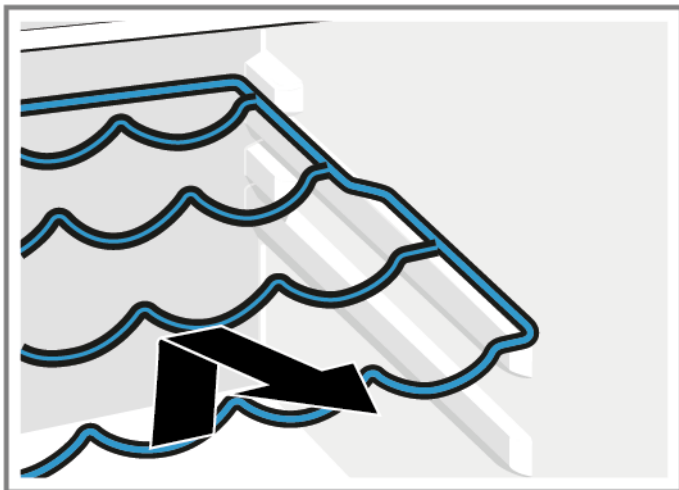

- ➡ Табличката за бутилки е свалена.

4.8.2 Монтиране на табличката за бутилки

- ▶ Монтирайте в обратен ред.

4.9 Смяна на стелажа на вратата

Изискване:

- ✔ Вратата е отворена.

4.9.1 Изваждане на стелажа на вратата

- ▶ Повдигнете стелажа на вратата нагоре.

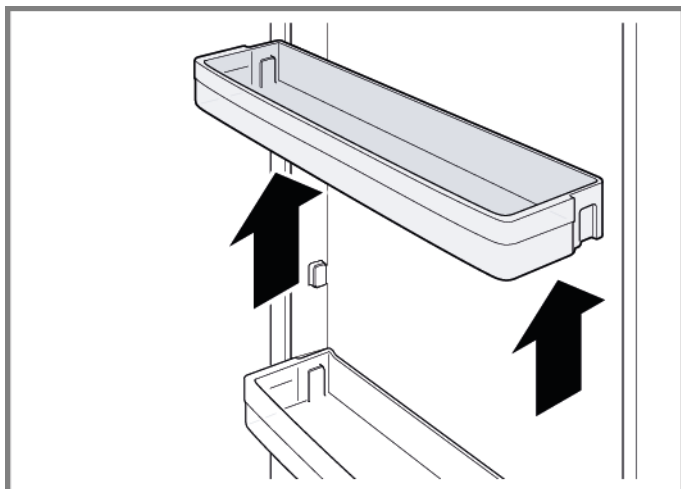

- ➡ Стелажът на вратата е свален.

4.9.2 Монтиране на стелажа на вратата

- ▶ Монтирайте в обратен ред.

4.10 Смяна на регулируемия стелаж на вратата

Изискване:

- ✔ Вратата е отворена.

4.10.1 Сваляне на регулируемия стелаж на вратата

- ▶ Преместете регулирания по височина стелаж на вратата нагоре, докато се освободи от държача.

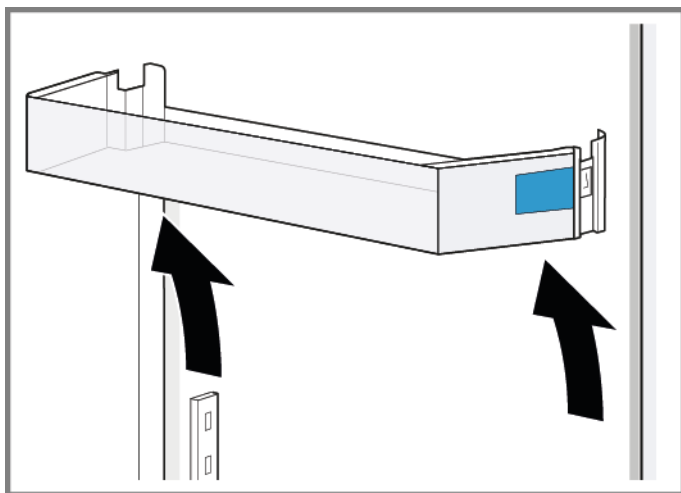

- ➡ Регулируемият стелаж на вратата е свален.

4.10.2 Монтиране на регулируемия стелаж на вратата

- ▶ Монтирайте в обратен ред.

4.11 Смяна на контейнера за замразени хранителни продукти

Изискване:

- ✔ Вратата е отворена.

4.11.1 Изваждане на контейнера за замразени хранителни продукти

- ▶ 1. Издърпайте докрай контейнера за замразени хранителни продукти (1).
- ▶ 2. Извадете контейнера за хранителни продукти (2).

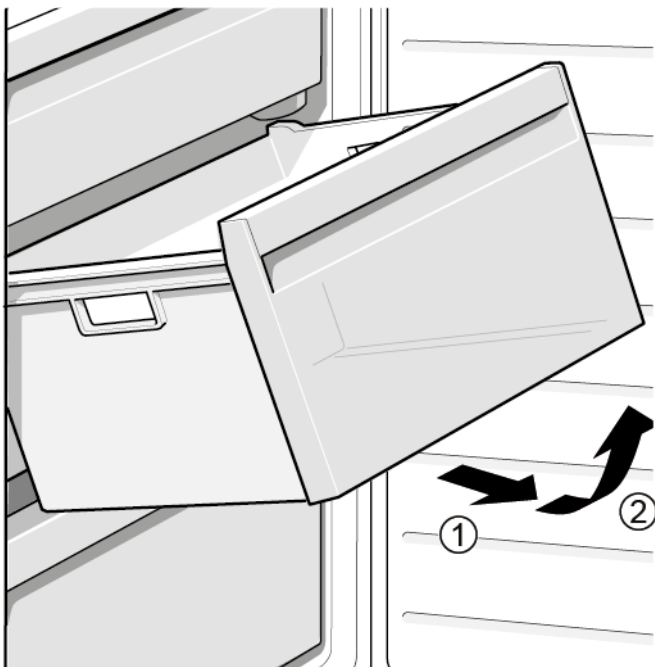

- ➡ Контейнерът за замразени хранителни продукти е изваден.

4.11.2 Монтиране на контейнера за замразени хранителни продукти

- ▶ Монтирайте в обратен ред.

4.12 Смяна на контейнера

Изискване:

- ✔ Вратата е отворена.

4.12.1 Изваждане на контейнера

- ▶ 1. Преместете долния контейнер на хладилника (1).
- ▶ 2. Преместете горния контейнер на хладилника (2).

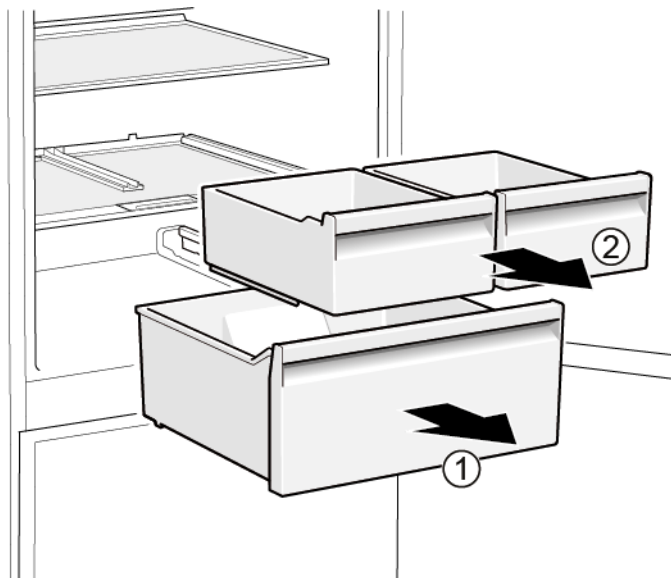

- ➡ Контейнерите са извадени.

4.12.2 Монтиране на контейнера

- ▶ Монтирайте в обратен ред.

4.13 Смяна на разтегателния контейнер

Изискване:

- ✔ Вратата е отворена.

4.13.1 Изваждане на разтегателния контейнер

- ▶ 1. Издърпайте напълно разтегателния контейнер (1).
- ▶ 2. Извадете разтегателния контейнер (2).

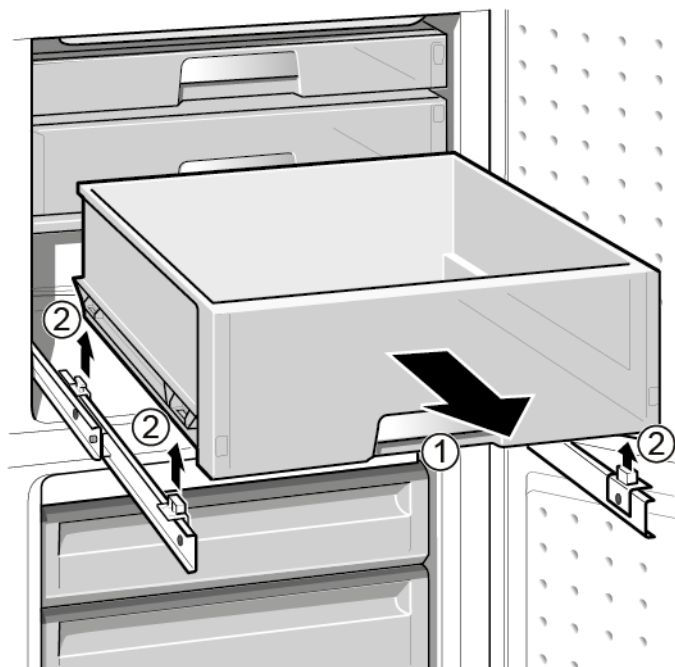

- ➡ Разтегателният контейнер е изваден.

4.13.2 Монтиране на разтегателния контейнер

- ▶ Монтирайте в обратен ред.

4.14 Смяна на LED спот лампата

Специални инструменти:

Специален инструмент

[00342180]



Вашият уред е снабден с LED осветление, което не изисква поддръжка.
Това осветление може да бъде ремонтирано само от специалисти от службата за обслужване на клиенти или от квалифицирани техници!



ОПАСНОСТ

Риск от токов удар поради части под напрежение!

Опасност за живота от токов удар в случай на неправилен ремонт

- ▶ Електрическите части трябва да се ремонтират от квалифицирани електротехници.
- ▶ След ремонта трябва да се извърши проверка за безопасност съгласно VDE 0701 или в съответствие със специфичните за страната разпоредби.



ОПАСНОСТ

Риск от токов удар поради части под напрежение!

Смърт от токов удар

- ▶ Изключете уредите от електрическото захранване поне 60 секунди преди започване на ремонта.



ВНИМАТЕЛНО

Остри ръбове!

Наранявания от порязване

- ▶ Носете предпазни ръкавици.

Изискване:

- ✓ Уредът е изключен от захранването.
- ✓ Вратата е отворена.

4.14.1 Сваляне на LED спот лампата

1. Използвайте специален инструмент, за да извадите LED спот лампата (1).

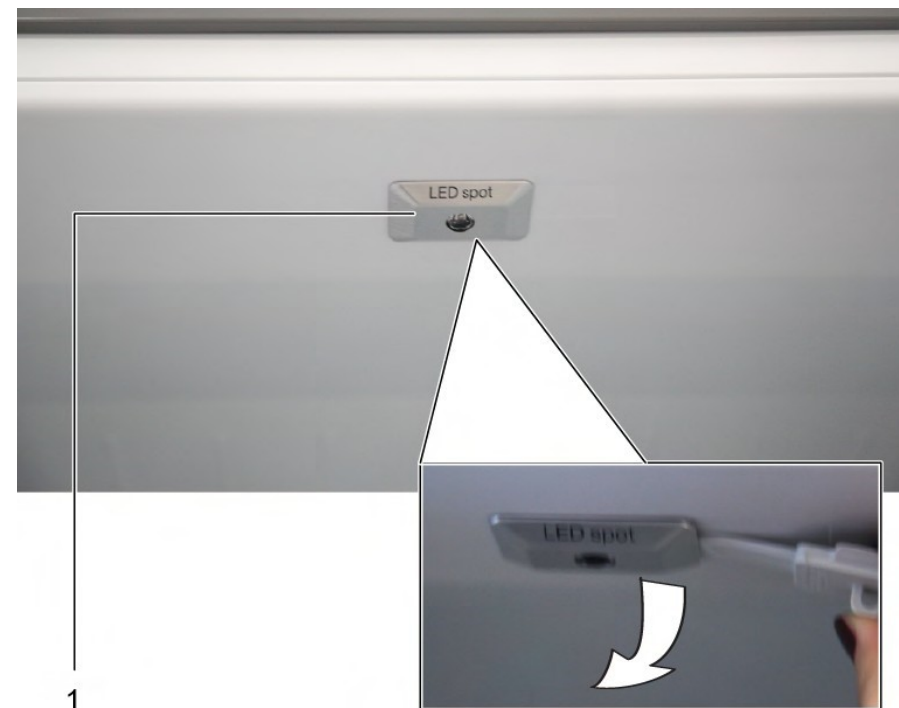

2. Изключете електрическите връзки на LED спот лампата.
- ➡ LED спот лампата е свалена.

4.14.2 Монтиране на LED спот лампата

- ▶ Монтирайте в обратен ред.

4.15 Смяна на LED осветлението отгоре

Специални инструменти:

-  Плоска отвертка Врѝх 2,4 мм x 0,4 мм x 60 мм, в комплекта [00341820]



	Вашият уред е снабден с LED осветление, което не изисква поддръжка. Това осветление може да бъде ремонтирано само от специалисти от службата за обслужване на клиенти или от квалифицирани техници!
---	---

	⚠ ОПАСНОСТ
	Риск от токов удар поради части под напрежение! Опасност за живота от токов удар в случай на неправилен ремонт <ul style="list-style-type: none"> ▶ Електрическите части трябва да се ремонтират от квалифицирани електротехници. ▶ След ремонта трябва да се извърши проверка за безопасност съгласно VDE 0701 или в съответствие със специфичните за страната разпоредби.

	⚠ ОПАСНОСТ
	Риск от токов удар поради части под напрежение! Смърт от токов удар <ul style="list-style-type: none"> ▶ Изключете уредите от електрическото захранване поне 60 секунди преди започване на ремонта.

	⚠ ВНИМАТЕЛНО
	Остри ръбове! Наранявания от порязване <ul style="list-style-type: none"> ▶ Носете предпазни ръкавици.

Изискване:

-  Уредът е изключен от захранването.
-  Вратата е отворена.
-  Горните вътрешни фитинги се отстраняват.

4.15.1 Сваляне на LED осветлението

1. Преместете LED осветлението наляво.



-  Свързването към електрическата мрежа на LED осветлението е прекъснато.

2. Освободете кукиите на LED осветлението.

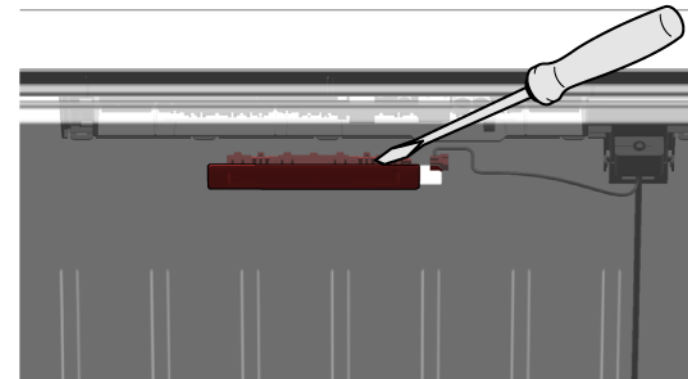

3. Свалете LED осветлението, придвижвайки го напред.

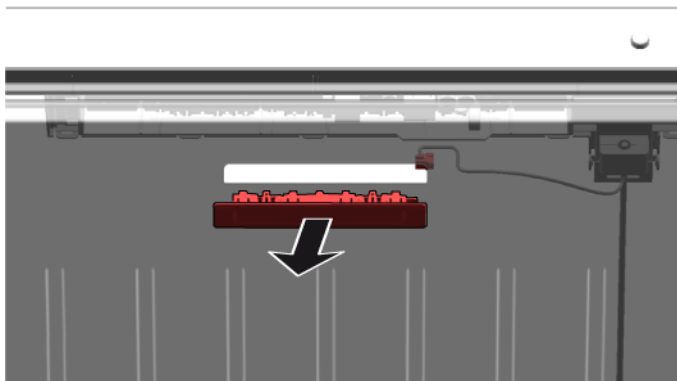

- ➡ LED осветлението е свалено.

4.15.2 Монтиране на LED осветлението отгоре

- ▶ Монтирайте в обратен ред.



4.16 Смяна на LED светлината на страничната лента



Специални инструменти:

 Смукателна чаша Ø50 мм [00342224]



	<p>Вашият уред е снабден с LED осветление, което не изисква поддръжка. Това осветление може да бъде ремонтирано само от специалисти от службата за обслужване на клиенти или от квалифицирани техници!</p>
---	--

	 ОПАСНОСТ
	<p>Риск от токов удар поради части под напрежение! Опасност за живота от токов удар в случай на неправилен ремонт</p> <ul style="list-style-type: none"> ▶ Електрическите части трябва да се ремонтират от квалифицирани електротехници. ▶ След ремонта трябва да се извърши проверка за безопасност съгласно VDE 0701 или в съответствие със специфичните за страната разпоредби.

	 ОПАСНОСТ
	<p>Риск от токов удар поради части под напрежение! Смърт от токов удар</p> <ul style="list-style-type: none"> ▶ Изключете уредите от електрическото захранване поне 60 секунди преди започване на ремонта.

	 ВНИМАТЕЛНО
	<p>Остри ръбове! Наранявания от порязване</p> <ul style="list-style-type: none"> ▶ Носете предпазни ръкавици.

Изискване:

-  Уредът е изключен от захранването.
-  Вратата е отворена.
-  Рафтовете на хладилното отделение са извадени.

4.16.1 Сваляне на LED светлината на страничната лента

1. Поставете смукателната чаша върху горната трета на LED светлината на страничната лента.



2. Издърпайте смукателната чаша с предната LED светлина на страничната лента с едно въртливо движение.

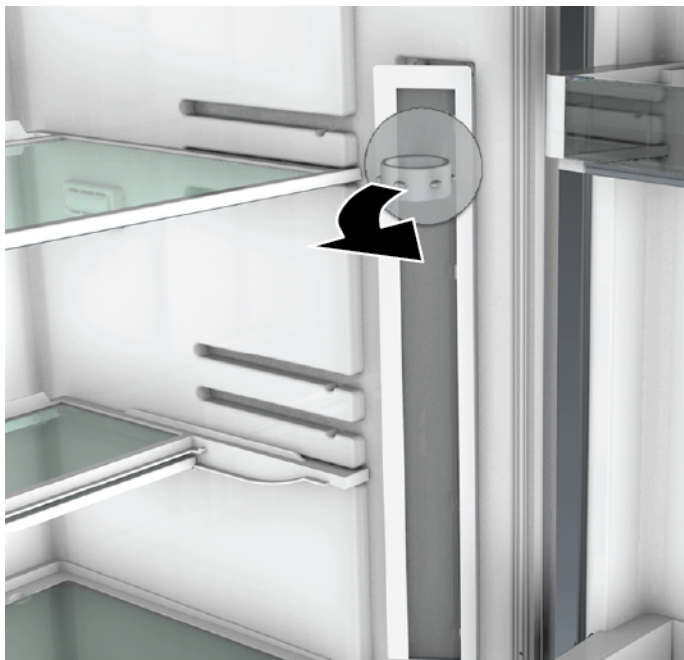



3. Изключете електрическата връзка на LED светлината на страничната лента.
➡ LED светлина на страничната лента е свалена.

4.16.2 Монтиране на LED светлината на страничната лента

1. Свържете електрическата връзка на LED светлината на страничната лента.
 2. Фиксирайте LED светлината на страничната лента на нейното място на стената на отделениято (куките щракват).
- ➡ LED светлината на страничната лента е монтирана.



4.17 Смяна на LED спот лампата



Специални инструменти:

-  Специален инструмент [00342180]
-  Плоска отвертка Връх 2,4 мм x 0,4 мм x 60 мм, в комплекта [00341820]



	<p>Вашият уред е снабден с LED осветление, което не изисква поддръжка. Това осветление може да бъде ремонтирано само от специалисти от службата за обслужване на клиенти или от квалифицирани техници!</p>
---	--

	<p style="text-align: center;"> ОПАСНОСТ</p> <p>Риск от токов удар поради части под напрежение! Опасност за живота от токов удар в случай на неправилен ремонт</p> <ul style="list-style-type: none"> ▶ Електрическите части трябва да се ремонтират от квалифицирани електротехници. ▶ След ремонта трябва да се извърши проверка за безопасност съгласно VDE 0701 или в съответствие със специфичните за страната разпоредби.
--	--

	<p style="text-align: center;"> ОПАСНОСТ</p> <p>Риск от токов удар поради части под напрежение! Смърт от токов удар</p> <ul style="list-style-type: none"> ▶ Изключете уредите от електрическото захранване поне 60 секунди преди започване на ремонта.
---	---

	<p style="text-align: center;"> ВНИМАТЕЛНО</p> <p>Остри ръбове! Наранявания от порязване</p> <ul style="list-style-type: none"> ▶ Носете предпазни ръкавици.
--	--

Изискване:

-  Уредът е изключен от захранването.
-  Вратата е отворена.
-  Рафтовете на хладилното отделение са извадени.

4.17.1 Сваляне на LED спот лампата

1. Освободете калъфа на LED спот лампата.

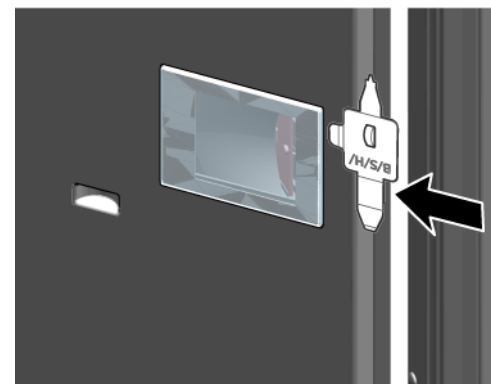

2. Издърпайте калъфа на LED спот лампата навътре и едновременно с натиснете напред.

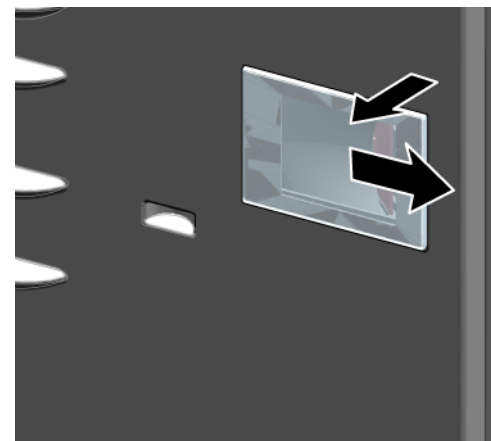

3. Отделете модула на LED спот лампата.

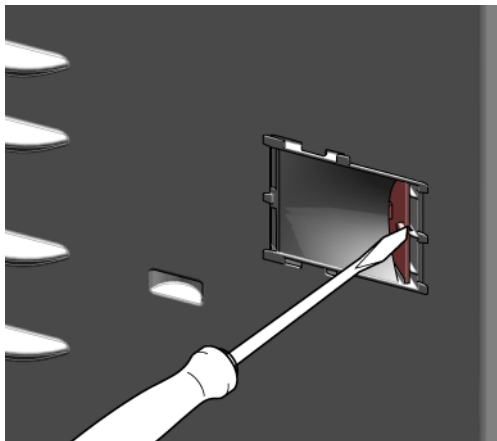

4. Изключете електрическата връзка на LED спот лампата.

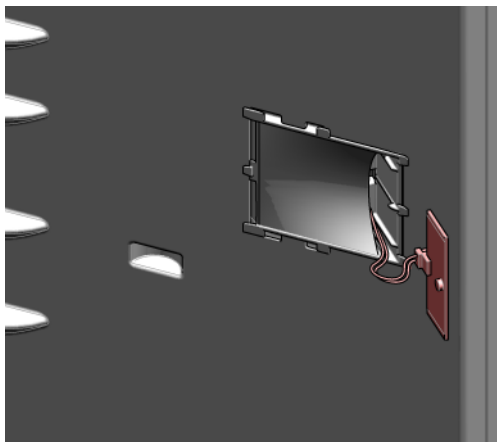





 LED спот лампата е свалена.

4.17.2 Монтиране на LED спот лампата

▶ Монтирайте в обратен ред.

Savjeti za popravak - Kombinacija hladnjak/zamrzivač

 O ovom dokumentu	32		
1.1 Važne informacije	32		
1.1.1 Svrha	32		
1.2 Objašnjenje oznaka	32		
1.2.1 Stupnjevi opasnosti	32		
1.2.2 Oznake opasnosti	32		
1.2.3 Struktura upozorenja	33		
1.2.4 Opće oznake	33		
 Sigurnost	34		
2.1 Opće sigurnosne upute	34		
2.1.1 Svi kućanski uređaji	34		
 Alat i pomagala	35		
 Popravak	36		
4.1 Zamjena brtve vrata	36		
4.1.1 Uklanjanje brtve vrata	36		
4.1.2 Postavljanje brtve vrata	36		
4.2 Zamjena ručke za vrata	39		
4.2.1 Uklanjanje ručke za vrata	39		
4.2.2 Postavljanje ručke za vrata	39		
4.3 Zamjena gornjeg zgloba vrata	40		
4.3.1 Uklanjanje gornjeg zgloba vrata	40		
4.3.2 Postavljanje gornjeg zgloba vrata	41		
4.4 Zamjena gornjeg zgloba vrata (vrata sa zaslonom)	42		
4.4.1 Uklanjanje gornjeg zgloba vrata	42		
4.4.2 Postavljanje gornjeg zgloba vrata	43		
4.5 Zamjena srednjeg zgloba vrata	44		
4.5.1 Uklanjanje srednjeg zgloba vrata	44		
4.5.2 Postavljanje srednjeg zgloba vrata	44		
4.6 Zamjena donjeg zgloba vrata	45		
4.6.1 Uklanjanje donjeg zgloba vrata	45		
4.6.2 Postavljanje donjeg zgloba vrata	45		
4.7 Zamjena police	46		
4.7.1 Uklanjanje police	46		
4.7.2 Postavljanje police	46		
4.8 Zamjena police za boce	47		
4.8.1 Uklanjanje police za boce	47		
4.8.2 Postavljanje police za boce	47		
4.9 Zamjena posude za vrata	48		
4.9.1 Uklanjanje posude za vrata	48		
4.9.2 Postavljanje posude za vrata	48		
4.10 Zamjena prilagodljive posude za vrata	49		
4.10.1 Uklanjanje prilagodljive posude za vrata	49		
4.10.2 Postavljanje prilagodljive posude za vrata	49		
4.11 Zamjena spremnika za zamrznute namirnice	50		
4.11.1 Uklanjanje spremnika za zamrznute namirnice	50		
4.11.2 Postavljanje spremnika za zamrznute namirnice	50		
4.12 Zamjena spremnika	51		
4.12.1 Uklanjanje spremnika	51		
4.12.2 Postavljanje spremnika	51		
4.13 Zamjena izvlačnog spremnika	52		
4.13.1 Uklanjanje izvlačnog spremnika	52		
4.13.2 Postavljanje izvlačnog spremnika	52		
4.14 Zamjena LED usmjerenog svjetla	53		
4.14.1 Uklanjanje LED usmjerenog svjetla	53		
4.14.2 Postavljanje LED usmjerenog svjetla	53		
4.15 Zamjena LED gornjeg svjetla	54		
4.15.1 Uklanjanje LED svjetla	54		
4.15.2 Postavljanje gornjeg LED svjetla	55		
4.16 Zamjena LED svjetlosne šipke	56		
4.16.1 Uklanjanje LED svjetlosne šipke	56		
4.16.2 Postavljanje LED svjetlosne šipke	57		
4.17 Zamjena LED usmjerenog svjetla	58		
4.17.1 Uklanjanje LED usmjerenog svjetla	58		
4.17.2 Postavljanje LED usmjerenog svjetla	59		

i O ovom dokumentu

1.1 Važne informacije

1.1.1 Svrha

Ove upute za popravak služe kao podrška korisnicima prilikom samostalnog popravljivanja uređaja u skladu s primjenjivom Direktivom o ekološkom dizajnu (od ožujka 2021.).

One sadrže informacije o zamjeni određenih rezervnih dijelova, kao i napomene o upozorenjima i opasnostima.

Ako imate dodatna pitanja, obratite se našoj službi za korisnike. Mi snosimo odgovornost za oštećenja samo u slučaju pridržavanja uputa za popravak.

1.2 Objašnjenje oznaka

1.2.1 Stupnjevi opasnosti

Stupnjevi upozorenja sastoje se od oznake i signalne riječi. Signalna riječ ukazuje na ozbiljnost opasnosti.





Stupanj upozorenja	Značenje
 OPASNOST	Nepridržavanje poruke upozorenja rezultirat će smrtnim ili teškim ozljedama.
 UPOZORENJE	Nepridržavanje poruke upozorenja može rezultirati smrtnim ili teškim ozljedama.
 OPREZ	Nepridržavanje poruke upozorenja može rezultirati lakšim ozljedama.
 POZORI!	Nepridržavanje poruke upozorenja može rezultirati oštećenjem imovine.

Tablica 1: Stupnjevi opasnosti



1.2.2 Oznake opasnosti

Oznake opasnosti simbolička su reprezentacija s oznakom vrste opasnosti.

U ovom dokumentu koriste se sljedeće oznake opasnosti:

Oznaka opasnosti	Značenje
	Opća poruka upozorenja
	Opasnost od električnog napona
	Opasnost od eksplozije
	Opasnost od porezotina
	Opasnost od prignječenja

O ovom dokumentu

Oznaka opasnosti	Značenje
	Opasnost od vrućih površina
	Opasnost od jakog magnetskog polja
	Opasnost od neionizirajućeg zračenja

Tablica 2: Oznake opasnosti

1.2.3 Struktura upozorenja

Upozorenja u ovom dokumentu imaju normirani izgled i strukturu.



	<div style="background-color: red; color: white; padding: 2px; text-align: center;"> OPASNOST</div> <p>Vrsta i izvor opasnosti! Moguće posljedice zanemarivanja opasnosti/upozorenja.</p> <ul style="list-style-type: none"> ▶ Mjere i zabrane za sprječavanje opasnosti.
--	---





Sljedeći primjer pokazuje upozorenje na strujni udar od dijelova koji provode struju. Spominje se mjera za izbjegavanje opasnosti.

	<div style="background-color: red; color: white; padding: 2px; text-align: center;"> OPASNOST</div> <p>Opasnost od strujnog udara zbog dijelova koji provode struju! Smrt od strujnog udara</p> <ul style="list-style-type: none"> ▶ Isključite uređaj iz električnog napajanja najmanje 60 sekundi prije izvođenja popravaka.
---	--

1.2.4 Opće oznake

U ovom dokumentu koriste se sljedeće opće oznake:

Opća znaka	Značenje
	Oznaka posebnog savjeta (tekst i/ili grafika)
	Oznaka jednostavnog savjeta (samo tekst)
	Oznaka veze na videovodič

Opća znaka	Značenje
	Oznaka potrebnog alata
	Oznaka potrebnih preduvjeta
	Oznaka uvjeta (ako ..., tad ...)
	Oznaka rezultata
[Početak]	Oznaka tipke ili gumba
[00123456]	Oznaka broja materijala
Status	Oznaka prikazanog teksta / prozor (na zaslonu uređaja)

Tablica 3: Opće oznake

2.1 Opće sigurnosne upute

2.1.1 Svi kućanski uređaji

Opasnost od strujnog udara zbog dijelova koji provode struju!

- Pogreške izazvane popravcima električnih sastavnih dijelova mogu dovesti do strujnog udara!
- Isključite uređaj iz struje na najmanje 60 sekundi prije početka radova.
- Nakon popravka provedite sigurnosni test u skladu s VDE 0701 ili nacionalnim propisima.

Opasnost od ozljeda zbog oštih rubova!

- Nosite zaštitne rukavice.

Opasnost od prignječenja tijekom izvođenja radova na popravcima, održavanju, rješavanju problema i servisiranju teških i pokretnih sastavnih dijelova

- Nosite zaštitnu obuću.
- Osigurajte teške sastavne dijelove od pada.
- Nemojte umetati dijelove tijela u pokretne sastavne dijelove.

Opasnost za sigurnost/rad uređaja!

- Koristite samo originalne rezervne dijelove.

Opasnost od oštećenja elektrostatički osjetljivih sastavnih dijelova (ESD)!

- Nemojte dodirivati module, uključujući priključke i rute vodiča.

Alat i pomagala

Oznaka	Pojedinosti	Slike
Zaštitna navlaka [00342013]	60 cm x 50 cm	
Odvijač s utorom	Nož 2,4 mm x 0,4 mm x 60 mm, u kompletu [00341820]	
Specijalni alat [00342180]		
Usisna čašica [00342224]	Ø50 mm	
Nastavak Torx TX20 [00340865]	6,3 mm (1/4")	
Odvijač s utorom	Nož 10 mm x 1,6 mm x 200 mm	

4.1 Zamjena brtve vrata

Zahtjev:

-  Vrata su otvorena.

4.1.1 Uklanjanje brtve vrata

1. Otpustite brtvu vrata iz utora u desnom i lijevom kutu.

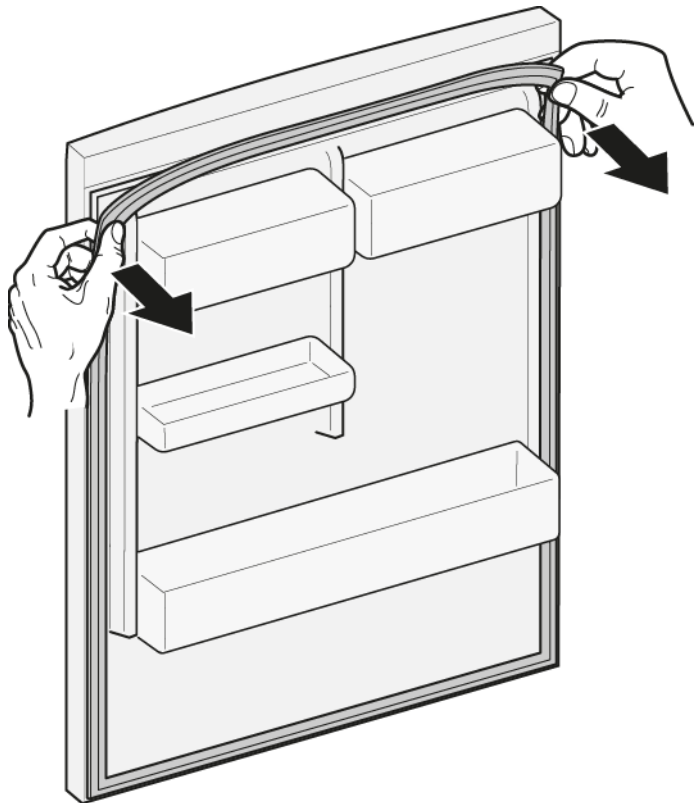

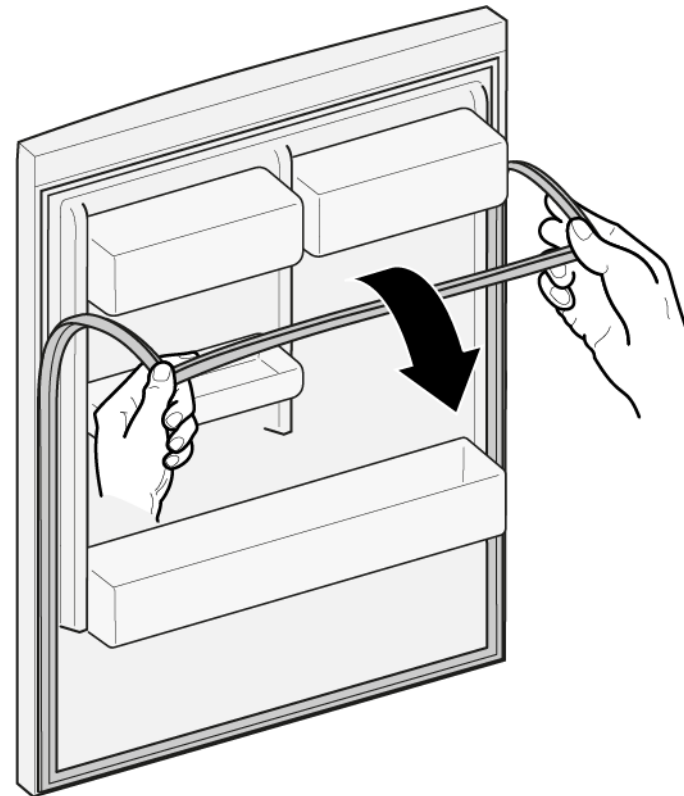

2. Izvucite brtvu vrata iz utora.



-  Brtva vrata je uklonjena.

4.1.2 Postavljanje brtve vrata

	Debljina nove brtve vrata može malo odstupati od debljine stare brtve vrata. To neće utjecati na zatvaranje i dugoročnu funkciju.
	Ako uređaj ima prilagodljive zglobove ili nastavke zglobova, možete dodatno optimizirati zatvaranje.
	Mali bočni otvori u brtvi vrata su funkcijski (potrebni za ventilaciju). Nije riječ o proizvodnim pogreškama.

1. Provjerite ima li oštećenja na utoru za brtvu.

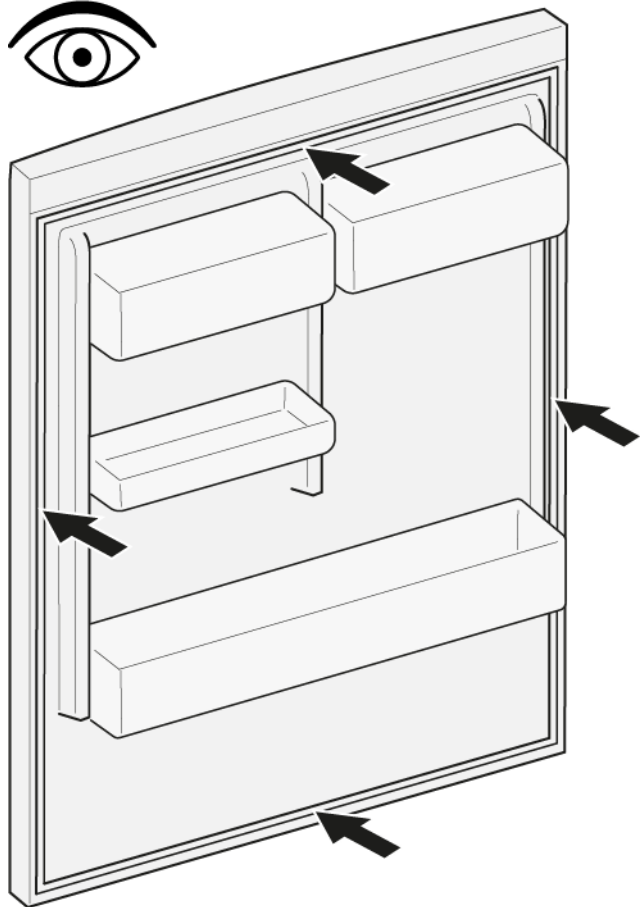

4. Gurnite kutove brtve na vrh i dno utora.

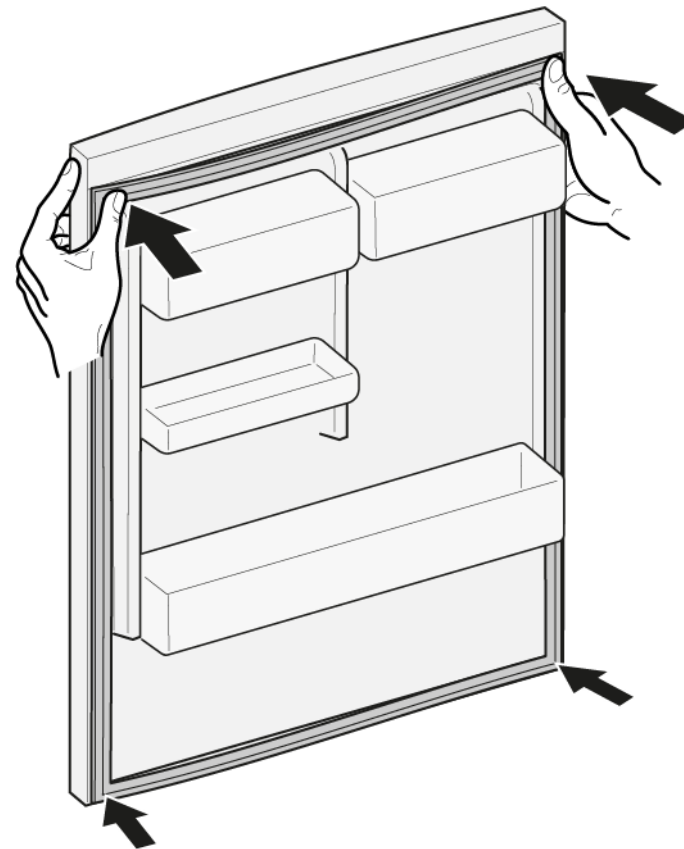



2.  Ako je utor za brtvu oštećen.
- Obratite se službi za korisnike.

3.  Blago odstupanje brtve vrata normalno je i ne utječe na funkciju. Preporučuje se izravnati brtvu vrata prije umetanja u uređaj.

Zagrijte brtvu vrata sušilom za kosu ili vrućom vodom i ručno je oblikujte.

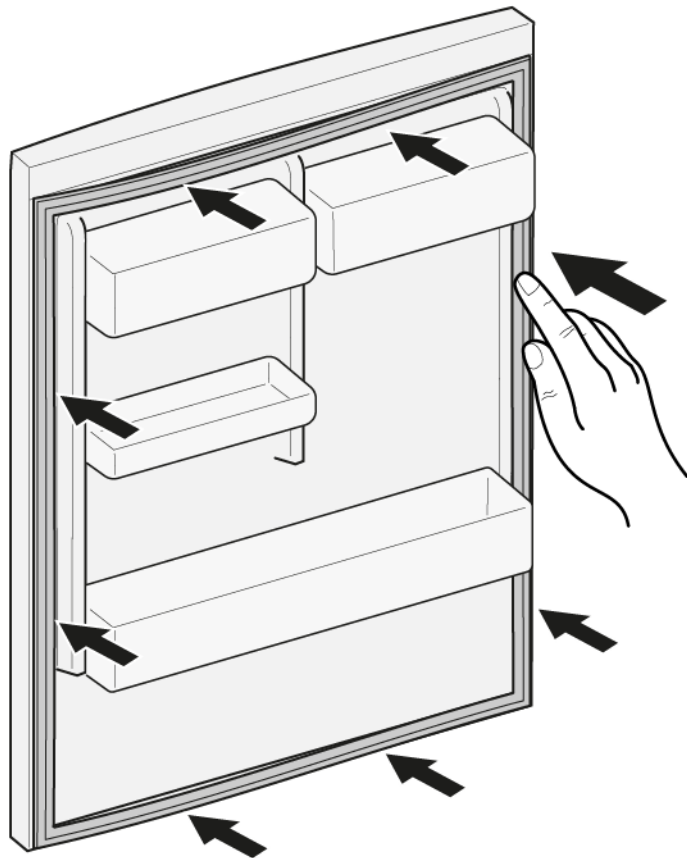

5. Utisnite cijelu brtvu korak po korak u utor.





 Brtva vrata je postavljena.

4.2 Zamjena ručke za vrata

Specijalni alati:

- | | | |
|---|-----------------------------|------------|
|  Nastavak Torx TX20 | 6,3 mm (1/4") | [00340865] |
|  Odvijač s utorom | Nož 10 mm x 1,6 mm x 200 mm | |

Zahtjev:

-  Uređaj je isključen iz napajanja.
-  Vrata su otvorena.

4.2.1 Uklanjanje ručke za vrata

- ▶ 1. Uklonite dva navojna čepa (1).
- ▶ 2. Odvijte dva vijka (2).
- ▶ 3. Uklonite ručku za vrata (3).

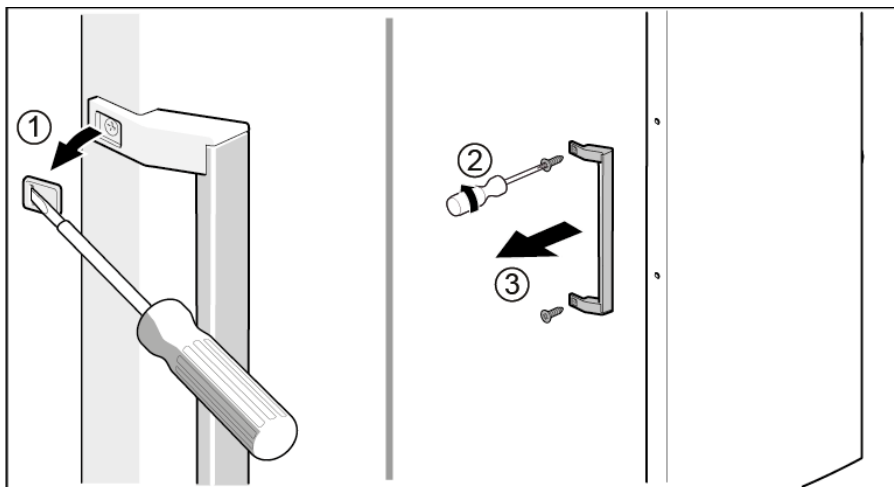

-  Ručka za vrata je uklonjena.



Ručka za druga vrata može se ukloniti na isti način.

4.2.2 Postavljanje ručke za vrata

- ▶ Postavite obratnim redoslijedom.

4.3 Zamjena gornjeg zgloba vrata

Specijalni alati:

🔧 Nastavak Torx TX20 6,3 mm (1/4") [00340865]

	⚠️ UPOZORENJE
Teški, veliki uređaji!	
Ozljede leđa i kralježnice	
<ul style="list-style-type: none"> ▶ Uklanjanje vrata uređaja smiju obavljati samo obučeni stručnjaci. ▶ Za pomicanje uređaja potrebne su dvije osobe. ▶ Koristite samo prikladan alat i opremu. 	

	⚠️ OPREZ
Oštri rubovi!	
Porezotine	
<ul style="list-style-type: none"> ▶ Nosite zaštitne rukavice. 	

	⚠️ UPOZORENJE
Isklizavanje nagnutih uređaja!	
Puknuća kostiju / ozljede od prignječenja	
<ul style="list-style-type: none"> ▶ Osigurajte uređaje od isklizavanja. 	

	⚠️ OPREZ
Opasnost od padanja dijelova zbog otpuštenih vijaka!	
Ozljeda od dijelova koji padaju.	
<ul style="list-style-type: none"> ▶ Osigurajte sastavne dijelove od pada. 	

	POZOR!
Opasnost od padanja dijelova zbog otpuštenih vijaka!	
Oštećenje drugih dijelova uređaja ili objekta klijenta, npr. poda.	
<ul style="list-style-type: none"> ▶ Osigurajte sastavne dijelove od pada. 	

Zahtjev:

- ✔ Uređaj je isključen iz napajanja.
- ✔ Unutarnja oprema uređaja je uklonjena.

4.3.1 Uklanjanje gornjeg zgloba vrata

1. Postavite uređaj na poledinu.

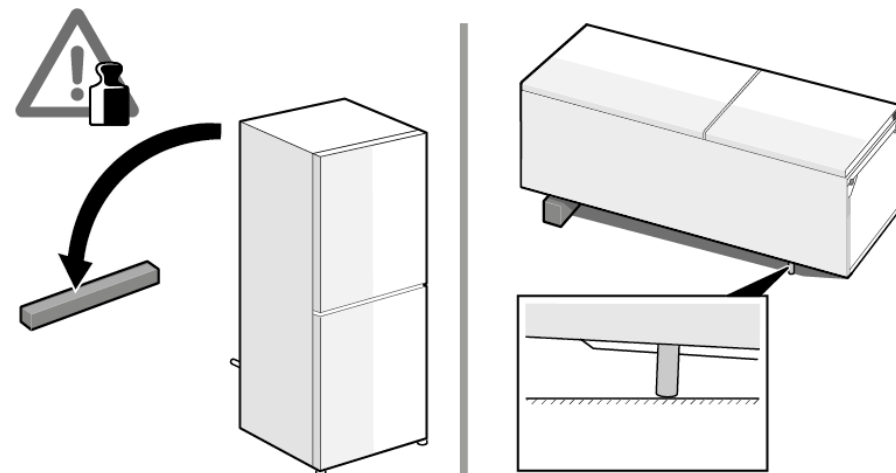

Popravak

2. 1. Pritisnite poklopac gornjeg zgloba s obje strane (1).
2. Izvadite poklopac gornjeg zgloba (2).
3. Okrenite poklopac zgloba (3).
4. Uklonite poklopac gornjeg zgloba (4).
5. Odvijte dva vijka (5).
6. Uklonite gornji zglob (6)/

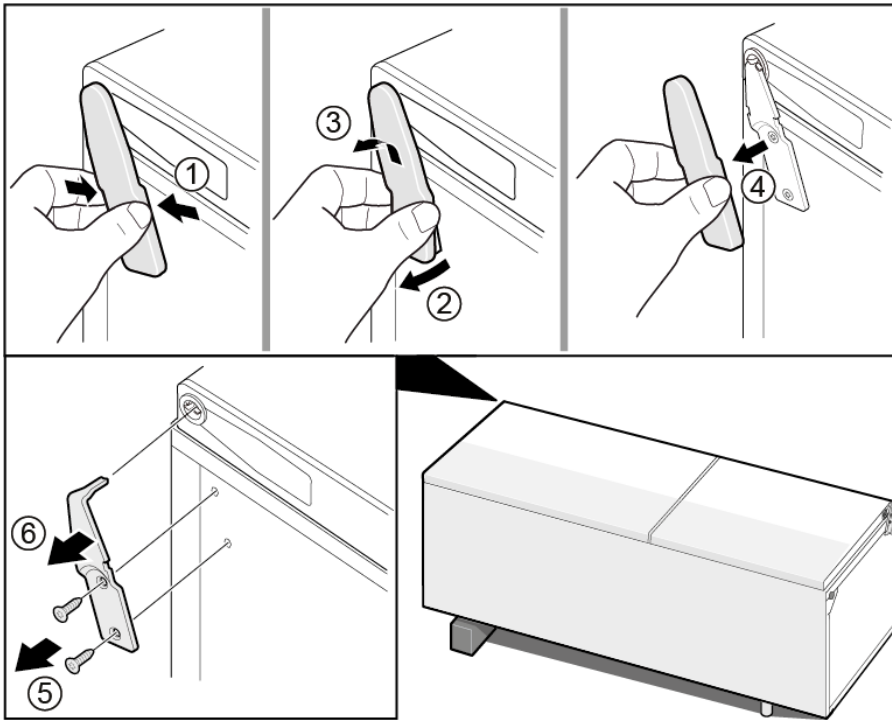

 Gornji je zglob uklonjen.

4.3.2 Postavljanje gornjeg zgloba vrata

- ▶ Postavite obratnim redoslijedom.

4.4 Zamjena gornjeg zgloba vrata (vrata sa zaslonom)

Specijalni alati:

🌀 Nastavak Torx TX20 6,3 mm (1/4") [00340865]

	⚠️ UPOZORENJE
	<p>Teški, veliki uređaji! Ozljede leđa i kralježnice</p> <ul style="list-style-type: none"> ▶ Uklanjanje vrata uređaja smiju obavljati samo obučeni stručnjaci. ▶ Za pomicanje uređaja potrebne su dvije osobe. ▶ Koristite samo prikladan alat i opremu.

	⚠️ OPREZ
	<p>Oštri rubovi! Porezotine</p> <ul style="list-style-type: none"> ▶ Nosite zaštitne rukavice.

	⚠️ UPOZORENJE
	<p>Isklizavanje nagnutih uređaja! Puknuća kostiju / ozljede od prignječenja</p> <ul style="list-style-type: none"> ▶ Osigurajte uređaje od isklizavanja.

	⚠️ OPREZ
	<p>Opasnost od padanja dijelova zbog otpuštenih vijaka! Ozljeda od dijelova koji padaju.</p> <ul style="list-style-type: none"> ▶ Osigurajte sastavne dijelove od pada.

	POZOR!
	<p>Opasnost od padanja dijelova zbog otpuštenih vijaka! Oštećenje drugih dijelova uređaja ili objekta klijenta, npr. poda.</p> <ul style="list-style-type: none"> ▶ Osigurajte sastavne dijelove od pada.

	⚠️ OPASNOST
	<p>Opasnost od strujnog udara zbog dijelova koji provode struju! U slučaju nepravilnog popravka može doći do opasnosti za život od strujnog udara</p> <ul style="list-style-type: none"> ▶ Električne dijelove mora popraviti kvalificirani električar. ▶ Nakon popravka provedite sigurnosni test u skladu s VDE 0701 ili nacionalnim propisima.

	⚠️ OPASNOST
	<p>Opasnost od strujnog udara zbog dijelova koji provode struju! Smrt od strujnog udara</p> <ul style="list-style-type: none"> ▶ Isključite uređaj iz električnog napajanja najmanje 60 sekundi prije izvođenja popravaka.

Zahtjev:

- ✅ Uređaj je isključen iz napajanja.
- ✅ Unutarnja oprema uređaja je uklonjena.

4.4.1 Uklanjanje gornjeg zgloba vrata

1. Postavite uređaj na poleđinu.

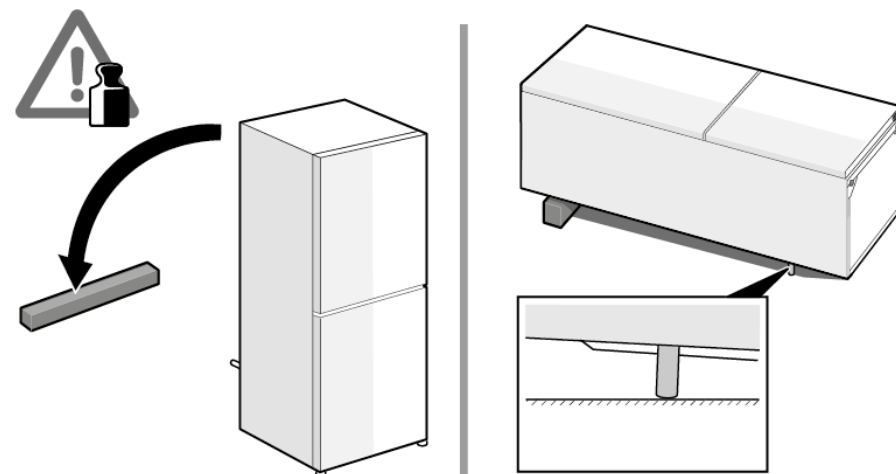

Popravak

2. 1. Uklonite poklopac gornjeg zgloba (1).
2. Uklonite poklopac kutije za kabele (2).
3. Odvojite električni priključak (3).
4. Odvijte vijak priključka za uzemljenje (4).
5. Uklonite zaštitu kabela (5).
6. Odvijte vijak (6)

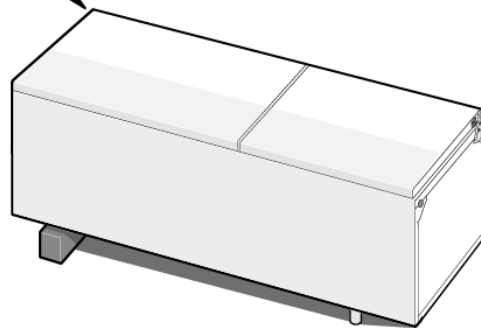
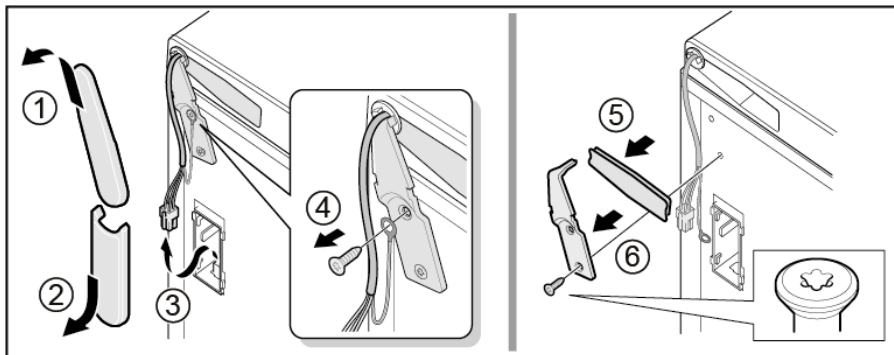

 Gornji je zglob uklonjen.

4.4.2 Postavljanje gornjeg zgloba vrata

- ▶ Postavite obratnim redoslijedom.

4.5 Zamjena srednjeg zgloba vrata

Specijalni alati:

🌀 Nastavak Torx TX20 6,3 mm (1/4") [00340865]

	⚠️ UPOZORENJE
	<p>Teški, veliki uređaji! Ozljede leđa i kralježnice</p> <ul style="list-style-type: none"> ▶ Uklanjanje vrata uređaja smiju obavljati samo obučeni stručnjaci. ▶ Za pomicanje uređaja potrebne su dvije osobe. ▶ Koristite samo prikladan alat i opremu.

	⚠️ OPREZ
	<p>Oštri rubovi! Porezotine</p> <ul style="list-style-type: none"> ▶ Nosite zaštitne rukavice.

	⚠️ UPOZORENJE
	<p>Isklizavanje nagnutih uređaja! Puknuća kostiju / ozljede od prignječenja</p> <ul style="list-style-type: none"> ▶ Osigurajte uređaje od isklizavanja.

	⚠️ OPREZ
	<p>Opasnost od padanja dijelova zbog otpuštenih vijaka! Ozljeda od dijelova koji padaju.</p> <ul style="list-style-type: none"> ▶ Osigurajte sastavne dijelove od pada.

	POZOR!
	<p>Opasnost od padanja dijelova zbog otpuštenih vijaka! Oštećenje drugih dijelova uređaja ili objekta klijenta, npr. poda.</p> <ul style="list-style-type: none"> ▶ Osigurajte sastavne dijelove od pada.

Zahtjev:

- ✔️ Uređaj je isključen iz napajanja.
- ✔️ Unutarnja oprema uređaja je uklonjena.
- ✔️ Gornji zglob vrata je uklonjen.

4.5.1 Uklanjanje srednjeg zgloba vrata

- ▶ 1. Uklonite vrata odjeljka hladnjaka (1).
- ▶ 2. Odvijte dva vijka (2).
- ▶ 3. Uklonite srednji zglob (3).

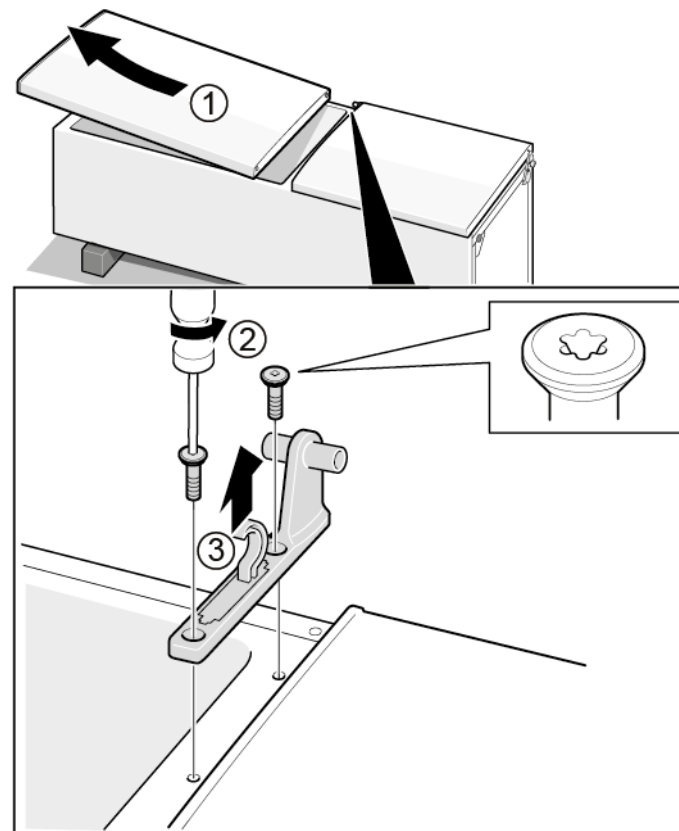

➡ Srednji je zglob uklonjen.

4.5.2 Postavljanje srednjeg zgloba vrata

- ▶ Postavite obratnim redoslijedom.

4.6 Zamjena donjeg zgloba vrata

Specijalni alati:

🌀 Nastavak Torx TX20 6,3 mm (1/4") [00340865]

	⚠ UPOZORENJE
	<p>Teški, veliki uređaji! Ozljede leđa i kralježnice</p> <ul style="list-style-type: none"> ▶ Uklanjanje vrata uređaja smiju obavljati samo obučeni stručnjaci. ▶ Za pomicanje uređaja potrebne su dvije osobe. ▶ Koristite samo prikladan alat i opremu.

	⚠ OPREZ
	<p>Oštri rubovi! Porezotine</p> <ul style="list-style-type: none"> ▶ Nosite zaštitne rukavice.

	⚠ UPOZORENJE
	<p>Isklizavanje nagnutih uređaja! Puknuća kostiju / ozljede od prignječenja</p> <ul style="list-style-type: none"> ▶ Osigurajte uređaje od isklizavanja.

	⚠ OPREZ
	<p>Opasnost od padanja dijelova zbog otpuštenih vijaka! Ozljeda od dijelova koji padaju.</p> <ul style="list-style-type: none"> ▶ Osigurajte sastavne dijelove od pada.

	POZOR!
	<p>Opasnost od padanja dijelova zbog otpuštenih vijaka! Oštećenje drugih dijelova uređaja ili objekta klijenta, npr. poda.</p> <ul style="list-style-type: none"> ▶ Osigurajte sastavne dijelove od pada.

Zahtjev:

- ✔ Uređaj je isključen iz napajanja.
- ✔ Unutarnja oprema uređaja je uklonjena.
- ✔ Gornji je zglob uklonjen.
- ✔ Srednji je zglob uklonjen.

4.6.1 Uklanjanje donjeg zgloba vrata

- ▶ 1. Uklonite vrata odjeljka zamrzivača (1).
- ▶ 2. Odvijte vijak (2).
- ▶ 3. Izvadite donji zglob (3).
- ▶ 4. Uklonite donji zglob (4).

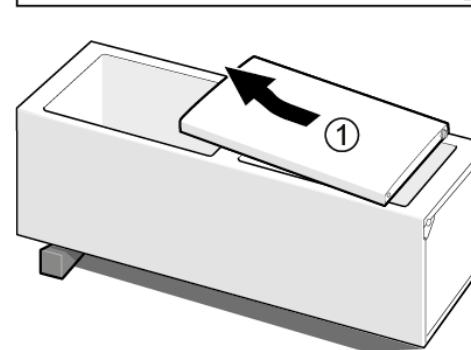
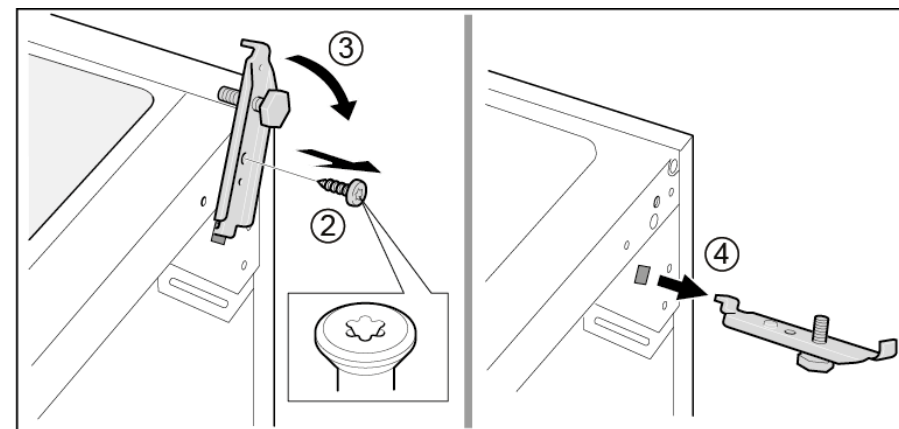

➡ Donji je zglob vrata uklonjen.

4.6.2 Postavljanje donjeg zgloba vrata

- ▶ Postavite obratnim redoslijedom.

4.7 Zamjena police

Zahtjev:

- ✔ Vrata su otvorena.

4.7.1 Uklanjanje police

- ▶ Izvucite policu.

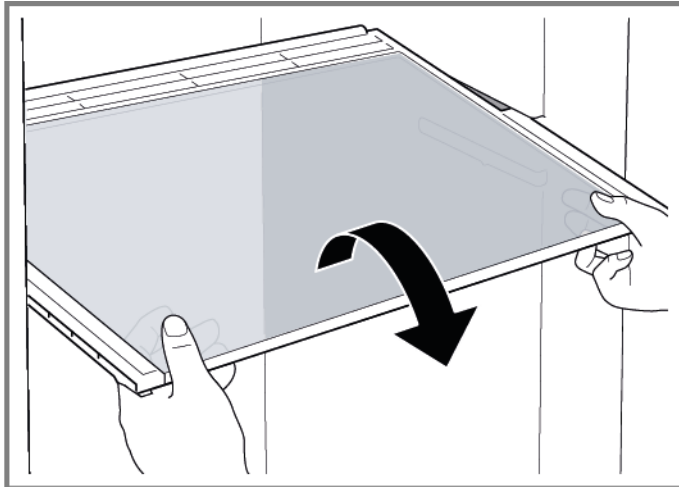

- ➡ Polica je uklonjena.

4.7.2 Postavljanje police

- ▶ Postavite obratnim redoslijedom.

4.8 Zamjena police za boce

Zahtjev:

- ✔ Vrata su otvorena.

4.8.1 Uklanjanje police za boce

- ▶ Izvucite policu za boce.

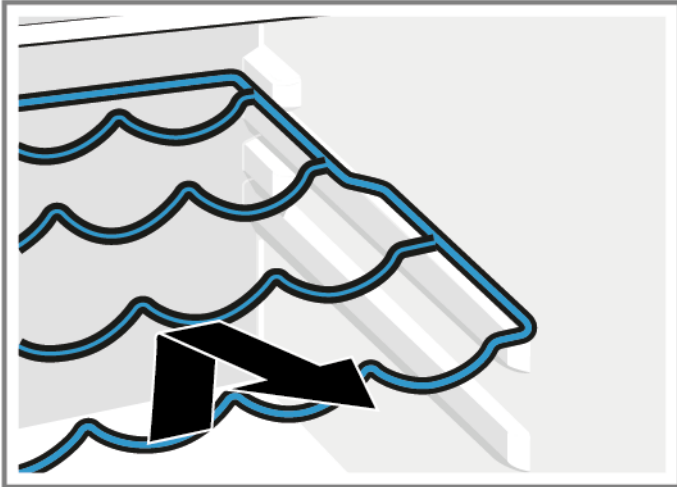

- ➡ Polica za boce je uklonjena.

4.8.2 Postavljanje police za boce

- ▶ Postavite obratnim redoslijedom.

4.9 Zamjena posude za vrata

Zahtjev:

- ✔ Vrata su otvorena.

4.9.1 Uklanjanje posude za vrata

- ▶ Podignite posudu za vrata prema gore.

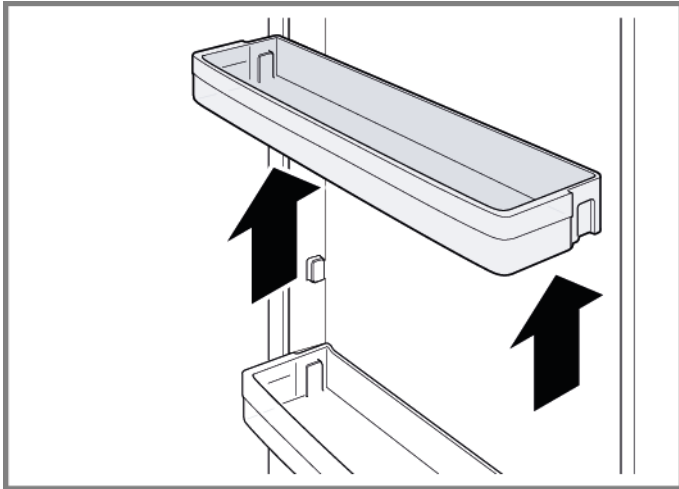

- ➡ Posuda za vrata je uklonjena.

4.9.2 Postavljanje posude za vrata

- ▶ Postavite obratnim redoslijedom.

4.10 Zamjena prilagodljive posude za vrata

Zahtjev:

- ✔ Vrata su otvorena.

4.10.1 Uklanjanje prilagodljive posude za vrata

- ▶ Pomaknite posudu za vrata prilagodljivu po visini prema gore dok se ne otpusti iz držača.

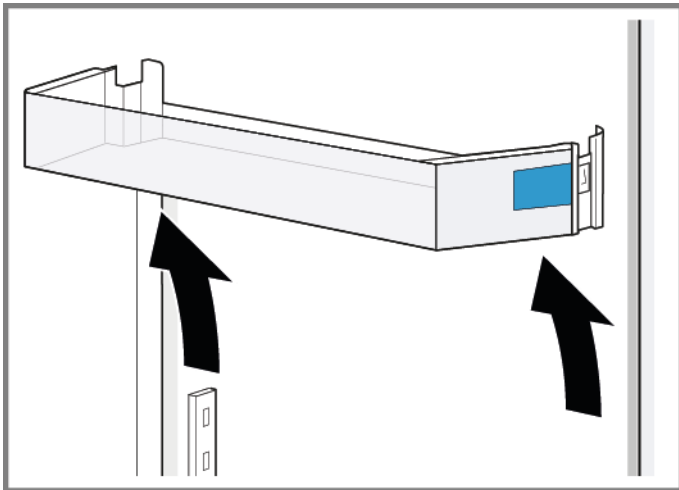

- ➡ Prilagodljiva posuda za vrata je uklonjena.

4.10.2 Postavljanje prilagodljive posude za vrata

- ▶ Postavite obratnim redoslijedom.

4.11 Zamjena spremnika za zamrznute namirnice

Zahtjev:

- ✔ Vrata su otvorena.

4.11.1 Uklanjanje spremnika za zamrznute namirnice

- ▶ 1. Potpuno izvucite spremnik za zamrznute namirnice (1).
- ▶ 2. Uklonite spremnik za hranu (2).

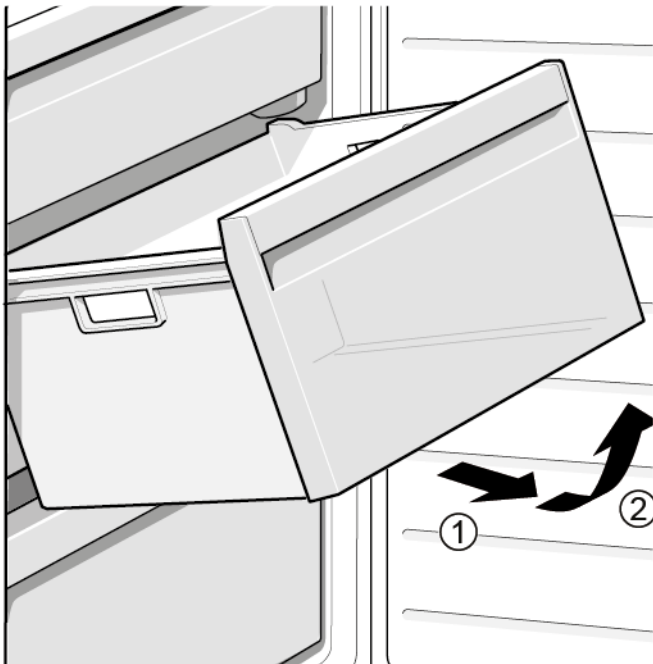

- ➡ Spremnik za zamrznute namirnice je uklonjen.

4.11.2 Postavljanje spremnika za zamrznute namirnice

- ▶ Postavite obratnim redoslijedom.

4.12 Zamjena spremnika

Zahtjev:

- ✔ Vrata su otvorena.

4.12.1 Uklanjanje spremnika

- ▶ 1. Izvadite donji spremnik hladnjaka (1).
- ▶ 2. Izvadite gornji spremnik hladnjaka (2).

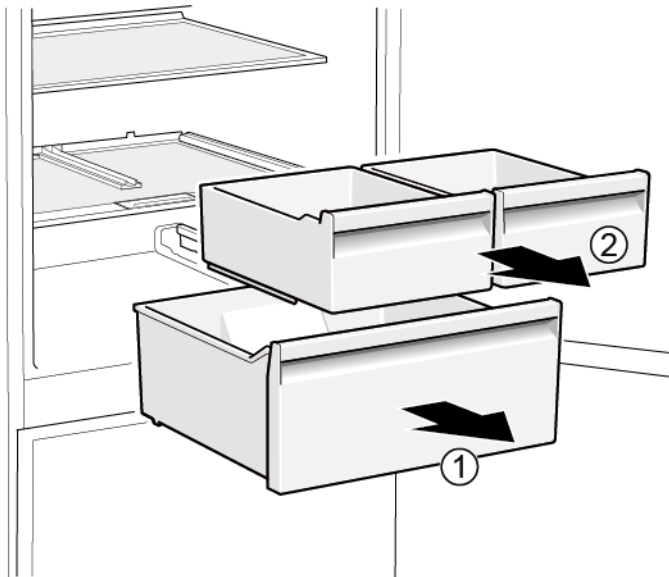

- ➡ Spremnici su uklonjeni.

4.12.2 Postavljanje spremnika

- ▶ Postavite obratnim redoslijedom.

4.13 Zamjena izvlačnog spremnika

Zahtjev:

- ✔ Vrata su otvorena.

4.13.1 Uklanjanje izvlačnog spremnika

- ▶ 1. Potpuno izvucite izvlačni spremnik (1).
- ▶ 2. Uklonite izvlačni spremnik (2).

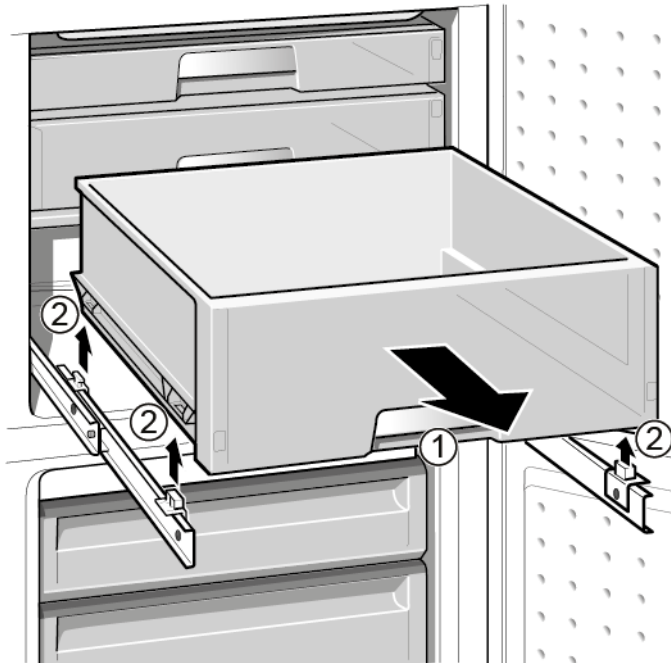

- ➡ Izvlačni spremnik je uklonjen.

4.13.2 Postavljanje izvlačnog spremnika

- ▶ Postavite obratnim redoslijedom.

4.14 Zamjena LED usmjerenog svjetla

Specijalni alati:

🔧 Specijalni alat [00342180]

i Uređaj ima svjetlo LED koje ne zahtijeva održavanje. Ta svjetla smije popravljati samo osoblje iz službe za korisnike ili ovlašteni tehničari!

⚠️ OPASNOST
Opasnost od strujnog udara zbog dijelova koji provode struju!
U slučaju nepravilnog popravka može doći do opasnosti za život od strujnog udara

- ▶ Električne dijelove mora popraviti kvalificirani električar.
- ▶ Nakon popravka provedite sigurnosni test u skladu s VDE 0701 ili nacionalnim propisima.

⚠️ OPASNOST
Opasnost od strujnog udara zbog dijelova koji provode struju!
Smrt od strujnog udara

- ▶ Isključite uređaj iz električnog napajanja najmanje 60 sekundi prije izvođenja popravaka.

⚠️ OPREZ
Oštri rubovi!
Porezotine

- ▶ Nosite zaštitne rukavice.

Zahtjev:

- ✔ Uređaj je isključen iz napajanja.
- ✔ Vrata su otvorena.

4.14.1 Uklanjanje LED usmjerenog svjetla

1. S pomoću specijalnog alata izvucite LED usmjerenog svjetla (1).

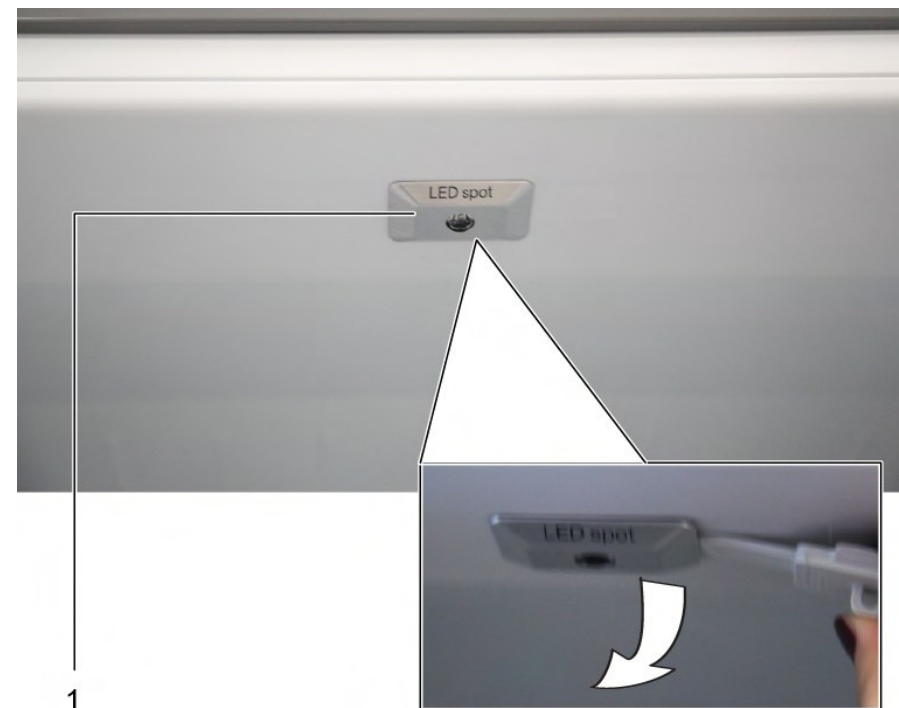

2. Odvojite električne priključke LED usmjerenog svjetla.
- ➡ LED usmjerenog svjetla je uklonjeno.

4.14.2 Postavljanje LED usmjerenog svjetla

- ▶ Postavite obratnim redoslijedom.

4.15 Zamjena LED gornjeg svjetla

Specijalni alati:

- 🔧 Odvijač s utorom Nož 2,4 mm x 0,4 mm x 60 mm, u kompletu [00341820]

	Uređaj ima svjetlo LED koje ne zahtijeva održavanje. Ta svjetla smije popravljati samo osoblje iz službe za korisnike ili ovlašteni tehničari!
---	--

	⚠️ OPASNOST Opasnost od strujnog udara zbog dijelova koji provode struju! U slučaju nepravilnog popravka može doći do opasnosti za život od strujnog udara <ul style="list-style-type: none">▶ Električne dijelove mora popraviti kvalificirani električar.▶ Nakon popravka provedite sigurnosni test u skladu s VDE 0701 ili nacionalnim propisima.
--	---

	⚠️ OPASNOST Opasnost od strujnog udara zbog dijelova koji provode struju! Smrt od strujnog udara <ul style="list-style-type: none">▶ Isključite uređaj iz električnog napajanja najmanje 60 sekundi prije izvođenja popravaka.
--	--

	⚠️ OPREZ Oštri rubovi! Porezotine <ul style="list-style-type: none">▶ Nosite zaštitne rukavice.
---	---

Zahtjev:

- ✔ Uređaj je isključen iz napajanja.
- ✔ Vrata su otvorena.
- ✔ Gornja unutarnja oprema je uklonjena.

4.15.1 Uklanjanje LED svjetla

1. Pomaknite LED svjetlo ulijevo.

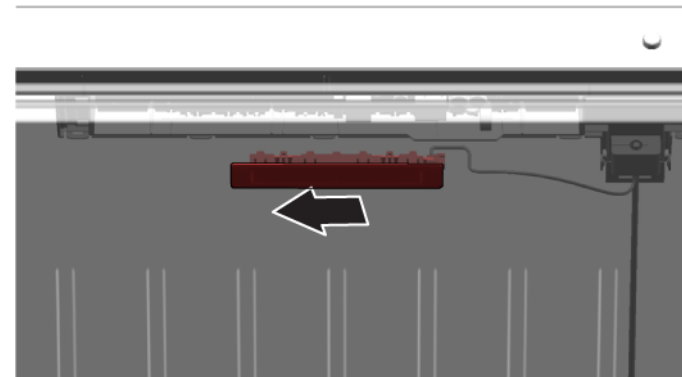

-  Električni priključak LED svjetla je odvojen.

2. Otпустите кукe LED свjetла.

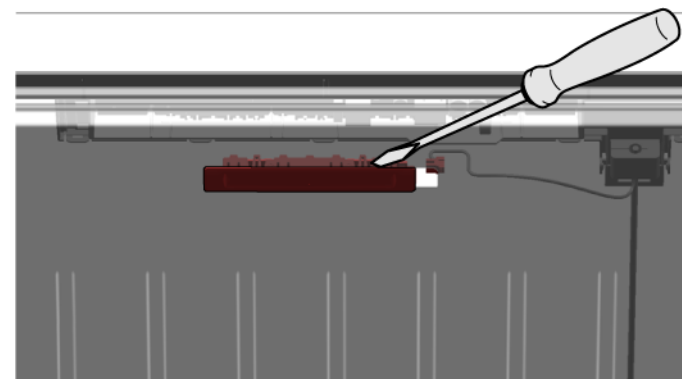

3. Uklonite LED svjetlo tako da ga pomaknete prema naprijed.

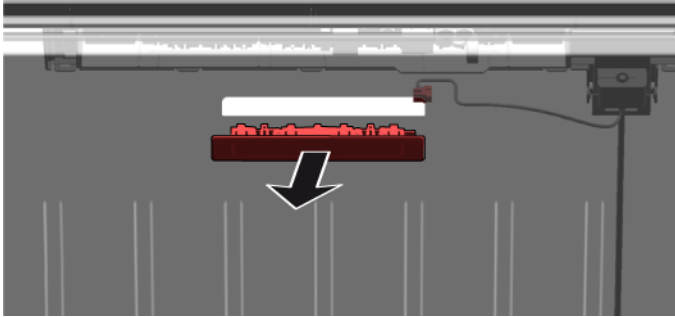

- ➡ LED svjetlo je uklonjeno.

4.15.2 Postavljanje gornjeg LED svjetla

- ▶ Postavite obratnim redoslijedom.

4.16 Zamjena LED svjetlosne šipke

Specijalni alati:

🌀 Usisna čašica Ø50 mm [00342224]



Uređaj ima svjetlo LED koje ne zahtijeva održavanje.
Ta svjetla smije popravljati samo osoblje iz službe za korisnike ili ovlaštene tehničari!



⚠️ OPASNOST

Opasnost od strujnog udara zbog dijelova koji provode struju!

U slučaju nepravilnog popravka može doći do opasnosti za život od strujnog udara

- ▶ Električne dijelove mora popraviti kvalificirani električar.
- ▶ Nakon popravka provedite sigurnosni test u skladu s VDE 0701 ili nacionalnim propisima.



⚠️ OPASNOST

Opasnost od strujnog udara zbog dijelova koji provode struju!

Smrt od strujnog udara

- ▶ Isključite uređaj iz električnog napajanja najmanje 60 sekundi prije izvođenja popravaka.



⚠️ OPREZ

Oštri rubovi!

Porezotine

- ▶ Nosite zaštitne rukavice.

Zahtjev:

- ✔ Uređaj je isključen iz napajanja.
- ✔ Vrata su otvorena.
- ✔ Police odjeljka hladnjaka su uklonjene.

4.16.1 Uklanjanje LED svjetlosne šipke

1. Postavite usisnu čašicu na gornju trećinu LED svjetlosne šipke.



2. Povucite usisnu čašicu prema naprijed sa LED svjetlosnom šipkom jednim okretom.

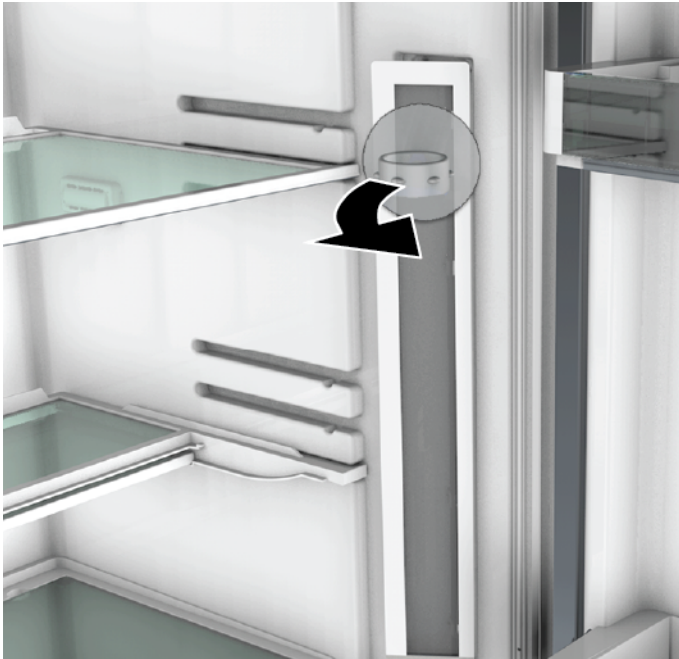

3. Odvojite električni priključak od LED svjetlosne šipke.
➡ LED svjetlosna šipka je uklonjena.

4.16.2 Postavljanje LED svjetlosne šipke

1. Priključite električni priključak LED svjetlosne šipke.
 2. Pričvrstite LED svjetlosnu šipku na mjesto na stijenci odjeljka (kuke će se uklopiti).
- ➡ LED svjetlosna šipka je postavljena.

4.17 Zamjena LED usmjerenog svjetla

Specijalni alati:

- 🔧 Specijalni alat [00342180]
- 🔧 Odvijač s utorom Nož 2,4 mm x 0,4 mm x 60 mm, u kompletu [00341820]

i Uređaj ima svjetlo LED koje ne zahtijeva održavanje. Ta svjetla smije popravljati samo osoblje iz službe za korisnike ili ovlašteni tehničari!

⚠️ OPASNOST
Opasnost od strujnog udara zbog dijelova koji provode struju!
U slučaju nepravilnog popravka može doći do opasnosti za život od strujnog udara

- ▶ Električne dijelove mora popraviti kvalificirani električar.
- ▶ Nakon popravka provedite sigurnosni test u skladu s VDE 0701 ili nacionalnim propisima.

⚠️ OPASNOST
Opasnost od strujnog udara zbog dijelova koji provode struju!
Smrt od strujnog udara

- ▶ Isključite uređaj iz električnog napajanja najmanje 60 sekundi prije izvođenja popravka.

⚠️ OPREZ
Oštri rubovi!
Porezotine

- ▶ Nosite zaštitne rukavice.

Zahtjev:

- ✔ Uređaj je isključen iz napajanja.
- ✔ Vrata su otvorena.
- ✔ Police odjeljka hladnjaka su uklonjene.

4.17.1 Uklanjanje LED usmjerenog svjetla

1. Otpustite poklopac LED usmjerenog svjetla.

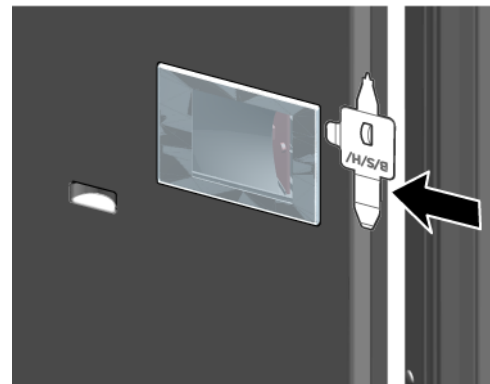

2. Povucite poklopac LED usmjerenog svjetla prema unutra i istodobno ga gurnite prema naprijed.

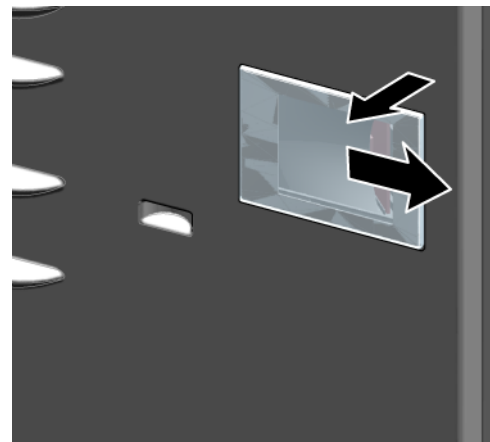

3. Odvojite modul LED usmjerenog svjetla.

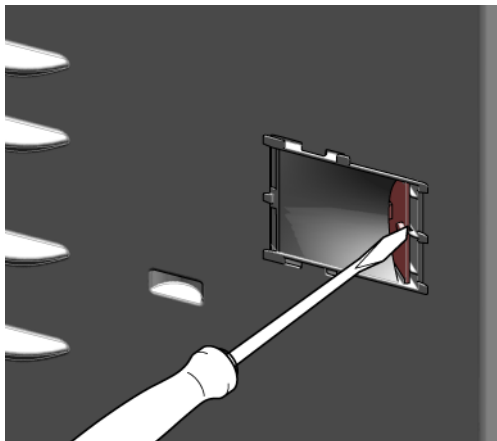

4. Odvojite električni priključak LED usmjerenog svjetla.

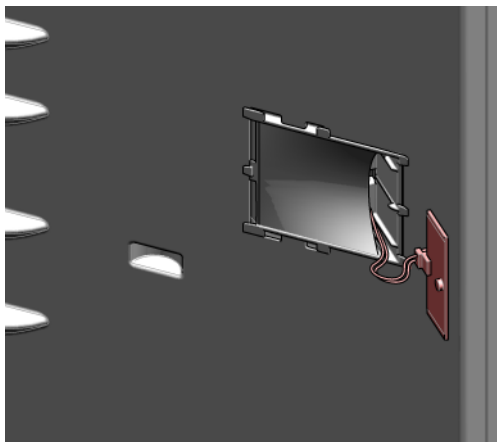





- ➔ LED usmjerenno svjetlo je uklonjeno.

4.17.2 Postavljanje LED usmjerenog svjetla

- ▶ Postavite obratnim redoslijedom.

Poznámky k opravě - Kombinace chladničky s mrazničkou

 O tomto dokumentu	61	4.8	Výměna držáku na láhve	76
1.1 Důležité informace	61	4.8.1	Vyjmutí držáku na láhve	76
1.1.1 Účel	61	4.8.2	Montáž držáku na láhve	76
1.2 Vysvětlení symbolů	61	4.9	Výměna dveřní přihrádky	77
1.2.1 Úroveň nebezpečí	61	4.9.1	Vyjmutí dveřní přihrádky	77
1.2.2 Symboly nebezpečí	61	4.9.2	Montáž dveřní přihrádky	77
1.2.3 Struktura výstrah	62	4.10	Výměna nastavitelné dveřní přihrádky	78
1.2.4 Obecné symboly	62	4.10.1	Vyjmutí nastavitelné dveřní přihrádky	78
 Bezpečnost	63	4.10.2	Montáž nastavitelné dveřní přihrádky	78
2.1 Všeobecné bezpečnostní pokyny	63	4.11	Výměna zásobníku na zmrazené potraviny	79
2.1.1 Všechny domácí spotřebiče	63	4.11.1	Vyjmutí zásobníku na zmrazené potraviny	79
 Nástroje a pomůcky	64	4.11.2	Montáž zásobníku na zmrazené potraviny	79
 Oprava	65	4.12	Výměna zásobníku	80
4.1 Výměna těsnění dvířek	65	4.12.1	Vyjmutí zásobníku	80
4.1.1 Vyjmutí těsnění dvířek	65	4.12.2	Montáž zásobníku	80
4.1.2 Montáž těsnění dvířek	65	4.13	Výměna výsuvného zásobníku	81
4.2 Výměna madla dvířek	68	4.13.1	Vyjmutí výsuvného zásobníku	81
4.2.1 Vyjmutí madla dvířek	68	4.13.2	Montáž výsuvného zásobníku	81
4.2.2 Montáž madla dvířek	68	4.14	Výměna LED bodového osvětlení	82
4.3 Výměna horního závěsu dvířek	69	4.14.1	Vyjmutí LED bodového osvětlení	82
4.3.1 Vyjmutí horního závěsu dvířek	69	4.14.2	Montáž LED bodového osvětlení	82
4.3.2 Montáž horního závěsu	70	4.15	Výměna LED horního osvětlení	83
4.4 Výměna horního závěsu dvířek (dvířka s ukazatelem)	71	4.15.1	Vyjmutí LED osvětlení	83
4.4.1 Vyjmutí horního závěsu dvířek	71	4.15.2	Montáž horního LED osvětlení	84
4.4.2 Montáž horního závěsu	72	4.16	Výměna LED osvětlení boční lišty	85
4.5 Výměna středního závěsu dvířek	73	4.16.1	Vyjmutí LED osvětlení boční lišty	85
4.5.1 Vyjmutí středního závěsu dvířek	73	4.16.2	Montáž LED osvětlení boční lišty	86
4.5.2 Montáž středního závěsu dvířek	73	4.17	Výměna LED bodového osvětlení	87
4.6 Výměna dolního závěsu dvířek	74	4.17.1	Vyjmutí LED bodového osvětlení	87
4.6.1 Vyjmutí spodního závěsu dvířek	74	4.17.2	Montáž LED bodového osvětlení	88
4.6.2 Montáž spodního závěsu dvířek	74			
4.7 Výměna odkládací plochy	75			
4.7.1 Vyjmutí odkládací plochy	75			
4.7.2 Montáž odkládací plochy	75			

i O tomto dokumentu

1.1 Důležité informace

1.1.1 Účel

Tyto pokyny k opravě pomáhají spotřebiteli při vlastnoruční opravě spotřebičů v souladu s platnými předpisy o ekodesignu (platnými k 03/2021).



Obsahují informace o výměně některých náhradních dílů včetně příslušných výstrah a nebezpečí.

V případě dotazů se obraťte na náš zákaznický servis. Za škody ručíme pouze v případě, že budou správně dodrženy pokyny k opravě.

1.2 Vysvětlení symbolů

1.2.1 Úroveň nebezpečí

Jednotlivé úrovně výstrah se skládají ze symbolu a signálního slova. Signální slova uvádějí závažnost nebezpečí.





Úroveň výstrahy	Význam
 NEBEZPEČÍ	Nedodržení výstražného upozornění způsobí smrt nebo vážná zranění.
 VÝSTRAHA	Nedodržení výstražného upozornění může způsobit smrt nebo vážná zranění.
 POZOR	Nedodržení výstražného upozornění může způsobit lehká zranění.
POZOR!	Nedodržení výstražného upozornění může způsobit škody na majetku.

Tabulka 1: Úroveň nebezpečí



1.2.2 Symboly nebezpečí

Symboly nebezpečí jsou symbolická znázornění určující druh nebezpečí.

V tomto dokumentu jsou použity následující symboly nebezpečí:

Symbol nebezpečí	Význam
	Obecné výstražné upozornění
	Nebezpečí vycházející z elektrického napětí
	Nebezpečí výbuchu
	Nebezpečí pořezání
	Nebezpečí rozdrcení



O tomto dokumentu

Symbol nebezpečí	Význam
	Nebezpečí spojené s horkými povrchy
	Nebezpečí vycházející ze silného elektromagnetického pole
	Nebezpečí z neionizujícího záření

Tabulka 2: Symboly nebezpečí

1.2.3 Struktura výstrah

Výstrahy použité v tomto dokumentu mají standardizovaný vzhled a strukturu.



	<div style="background-color: red; color: white; padding: 2px; text-align: center;"> NEBEZPEČÍ</div> <p>Typ a zdroj nebezpečí! Možné důsledky nedodržení výstražného upozornění.</p> <ul style="list-style-type: none"> ▶ Opatření a zákazy eliminující nebezpečí.
--	--





Následující příklad ukazuje výstrahu, která varuje před zásahem elektrickým proudem při dotyku dílů pod proudem. Je uvedeno opatření pro zabránění rizika.

	<div style="background-color: red; color: white; padding: 2px; text-align: center;"> NEBEZPEČÍ</div> <p>Nebezpečí úrazu elektrickým proudem při dotyku dílů pod proudem! Usmrcení elektrickým proudem</p> <ul style="list-style-type: none"> ▶ Odpojte spotřebič od přívodu elektrického proudu alespoň 60 sekund před zahájením opravy.
---	--

1.2.4 Obecné symboly

V tomto dokumentu jsou použity následující obecné symboly:

Obecný symbol	Význam
	Uvedení zvláštního tipu (text nebo grafické vyjádření)
	Uvedení jednoduchého tipu (pouze text)
	Uvedení odkazu k videonávodu

Obecný symbol	Význam
	Uvedení požadovaných nástrojů
	Uvedení požadovaných podmínek
	Uvedení podmínky (když, pak atd.)
	Uvedení výsledku
[Start]	Uvedení klávesy nebo tlačítka
[00123456]	Uvedení čísla materiálu
Status	Uvedení zobrazeného textu / okna (na ukazateli spotřebiče)

Tabulka 3: Obecné symboly

2.1 Všeobecné bezpečnostní pokyny

2.1.1 Všechny domácí spotřebiče

Nebezpečí úrazu elektrickým proudem při dotyku dílů pod proudem!

- Chyby při opravě elektrických součástí mohou vést k úrazu elektrickým proudem!
- Odpojte spotřebič ze sítě alespoň 60 sekund před zahájením prací.
- Po opravě nechte provést bezpečnostní zkoušku podle VDE 0701 nebo specifických předpisů dané země.

Nebezpečí poranění o ostré hrany!

- Používejte ochranné rukavice.

Nebezpečí rozdrčení během opravy, údržby, odstranění závad a servisu těžkými a pohyblivými součástmi

- Používejte bezpečnostní obuv.
- Zajistěte těžké součásti před pádem.
- Nesahejte na pohyblivé součásti.





Nebezpečí z hlediska bezpečnosti / funkce spotřebiče!

- Používejte pouze originální náhradní díly.

Nebezpečí poškození elektrostaticky citlivých součástí (elektrostatický výboj)!

- Nedotýkejte se modulů, včetně přípojek a vodičů.

Nástroje a pomůcky

Označení	Detaily	Snímky
Ochranná tkanina [00342013]	60 cm x 50 cm	
Plochý šroubovák	Čepel 2,4 mm x 0,4 mm x 60 mm, v sadě [00341820]	
Speciální nástroj [00342180]		
Přísavka [00342224]	Ø50 mm	
Torx Bit TX20 [00340865]	6,3 mm (1/4")	
Plochý šroubovák	Čepel 10 mm x 1,6 mm x 200 mm	

4.1 Výměna těsnění dvířek

Požadavek:

- ✓ Dvířka jsou otevřená.

4.1.1 Vyjmutí těsnění dvířek

1. Uvolněte těsnění dvířek z drážky v pravém a levém rohu.

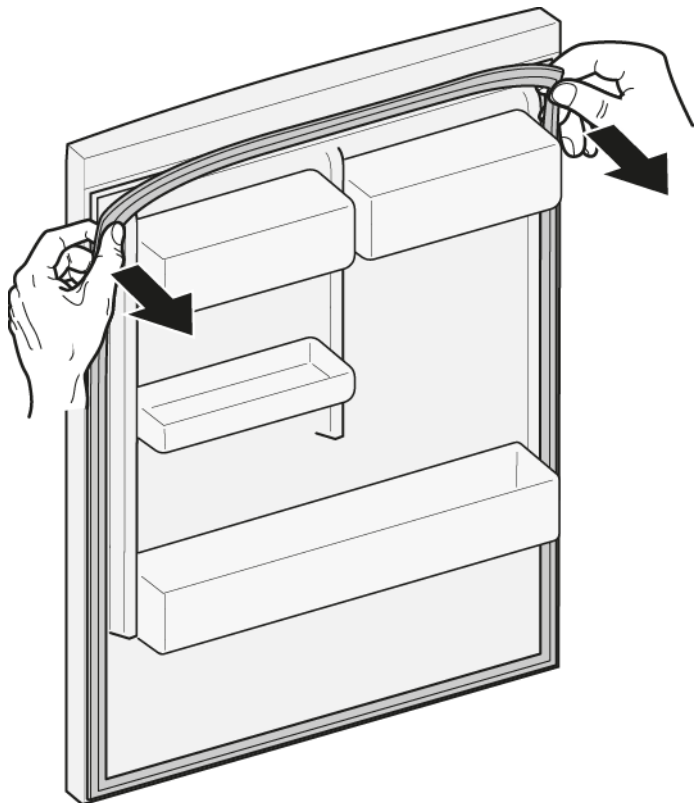



2. Vytáhněte těsnění z drážky.



- ➡ Těsnění dvířek je vyjmuté.

4.1.2 Montáž těsnění dvířek

	Nové těsnění dvířek může mít trochu jinou šířku než původní těsnění. Dovření dvířek ani dlouhodobá funkce tím nebudou ovlivněny.
	Pokud má spotřebič nastavitelné závěsy nebo nástavce závěsů, můžete dovření dvířek následně upravit.
	Malé boční otvory v těsnění dvířek jsou funkční (slouží pro přívod vzduchu). Nejsou vadou výrobku.

1. Zkontrolujte, zda není poškozena drážka těsnění.

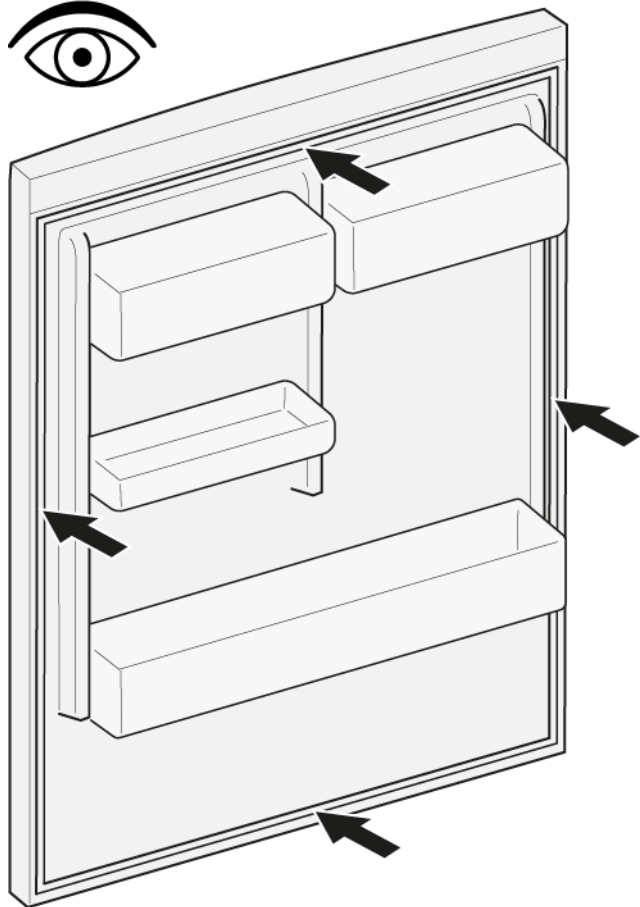

4. Zatlačte horní a dolní rohy těsnění do drážky.

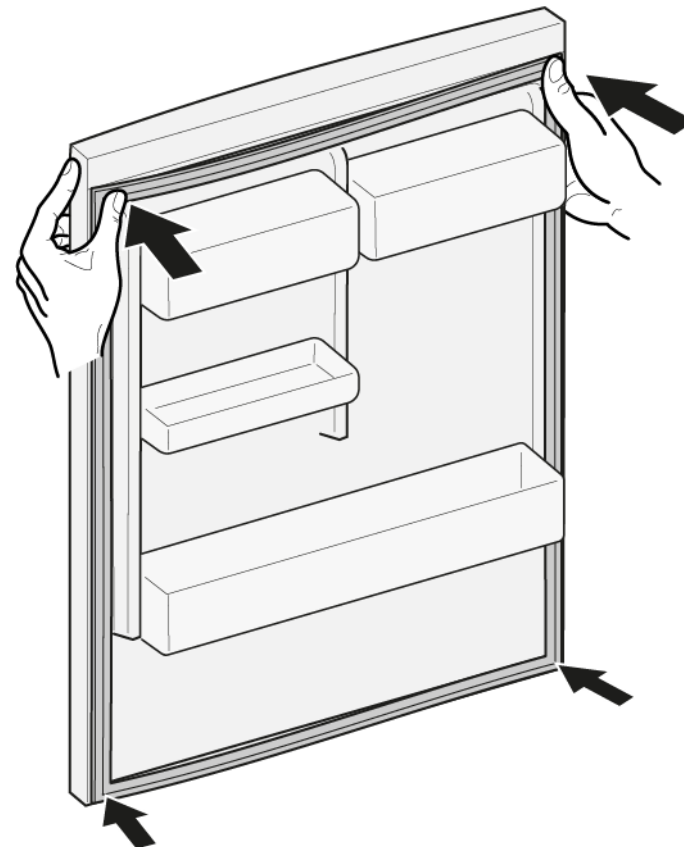

2.  Pokud je drážka těsnění poškozená,
- kontaktujte zákaznický servis.

3.  Lehká deformace těsnění dvířek je normální a nemá vliv na jeho funkci. Před vložením do spotřebiče doporučujeme těsnění narovnat.

Těsnění zahřejte fénem nebo horkou vodou a manuálně upravte jeho tvar.

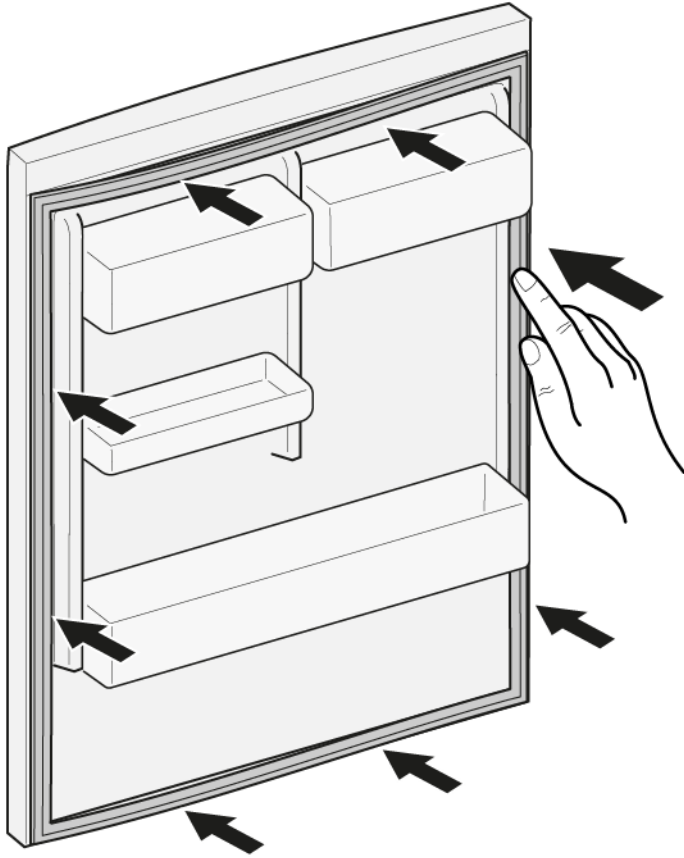

5. Postupně zatlačte do drážky celé těsnění.





 Těsnění dvířek je namontované.

4.2 Výměna madla dvířek

Speciální nástroje:

-  Torx Bit TX20 6,3 mm (1/4") [00340865]
-  Plochý šroubovák Čepel 10 mm x 1,6 mm x 200 mm

Požadavek:

-  Spotřebič je odpojený od přívodu elektrické energie.
-  Dvířka jsou otevřená.

4.2.1 Vyjmutí madla dvířek

- ▶ 1. Odstraňte dvě krytky šroubů (1).
- ▶ 2. Vyšroubujte dva šrouby (2).
- ▶ 3. Vyjměte madlo dvířek (3).

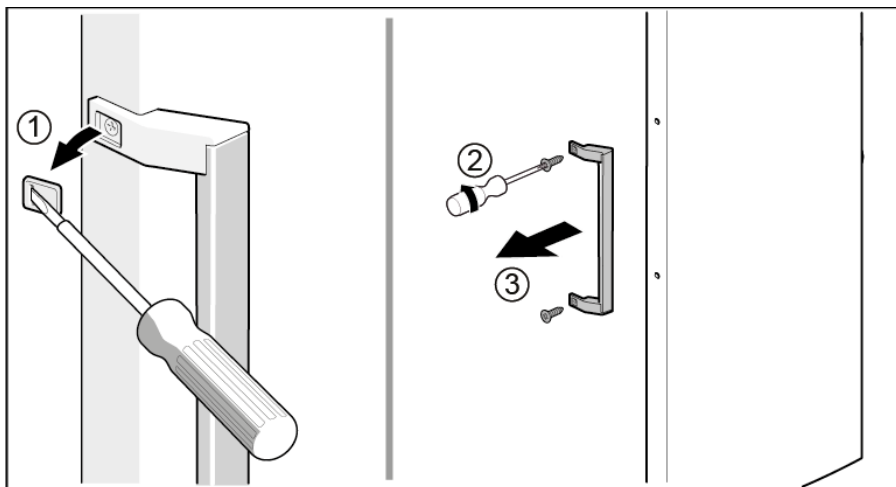

 Madlo dvířek je vyjmuté.



Madlo druhých dvířek může být vyjmuto stejným způsobem.

4.2.2 Montáž madla dvířek

- ▶ Montáž proveďte v opačném sledu.

4.3 Výměna horního závěsu dvířek

Speciální nástroje:

Torx Bit TX20

6,3 mm (1/4")

[00340865]

	<p style="text-align: center;">⚠ VÝSTRAHA</p> <p>Těžké, objemné spotřebiče! Poranění zad a svalů</p> <ul style="list-style-type: none"> ▶ Odstranění dvířek spotřebiče by měl provádět výhradně školený odborník. ▶ Pro manipulaci se spotřebičem jsou nutní dva lidé. ▶ Použijte pouze vhodné nástroje a zařízení.
	<p style="text-align: center;">⚠ POZOR</p> <p>Ostré hrany! Nebezpečí řezných poranění</p> <ul style="list-style-type: none"> ▶ Používejte ochranné rukavice.
	<p style="text-align: center;">⚠ VÝSTRAHA</p> <p>Sklouznutí nakloněných spotřebičů! Zlomeniny / poranění rozdrcením</p> <ul style="list-style-type: none"> ▶ Zajistěte spotřebiče proti sklouznutí.
	<p style="text-align: center;">⚠ POZOR</p> <p>Nebezpečí padajících dílů kvůli uvolněným šroubům! Poranění padajícími díly.</p> <ul style="list-style-type: none"> ▶ Zajistěte jednotlivé součásti před pádem.
	<p style="text-align: center;">POZOR!</p> <p>Nebezpečí padajících dílů kvůli uvolněným šroubům! Poškození jiných částí spotřebiče nebo prvků domácnosti zákazníka, např. podlahy.</p> <ul style="list-style-type: none"> ▶ Zajistěte jednotlivé součásti před pádem.

Požadavek:

- ✔ Spotřebič je odpojený od přívodu elektrické energie.
- ✔ Vnitřní kování spotřebiče je odstraněno.

4.3.1 Vyjmutí horního závěsu dvířek

1. Položte spotřebič na zadní stranu.

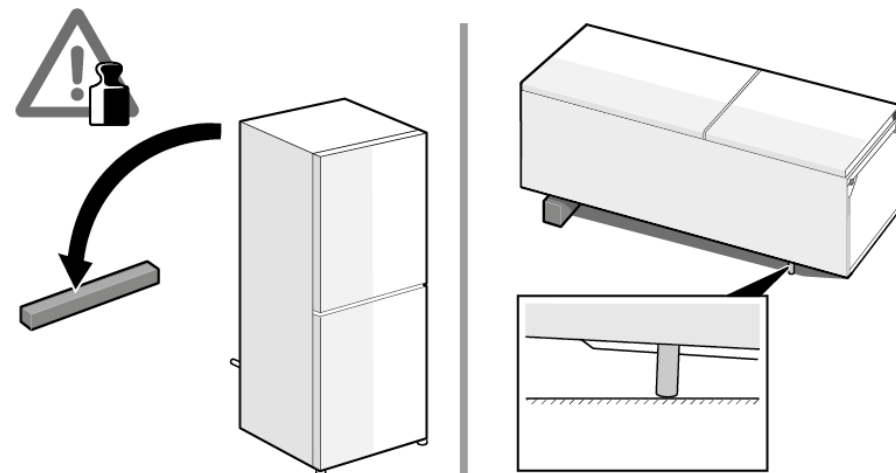

Oprava

2. 1. Na obou stranách stiskněte kryt horního závěsu (1).
2. Vysuňte kryt horního závěsu (2).
3. Otočte kryt závěsu (3).
4. Odstraňte kryt horního závěsu (4).
5. Vyšroubujte dva šrouby (5).
6. Vyjměte horní závěs (6).

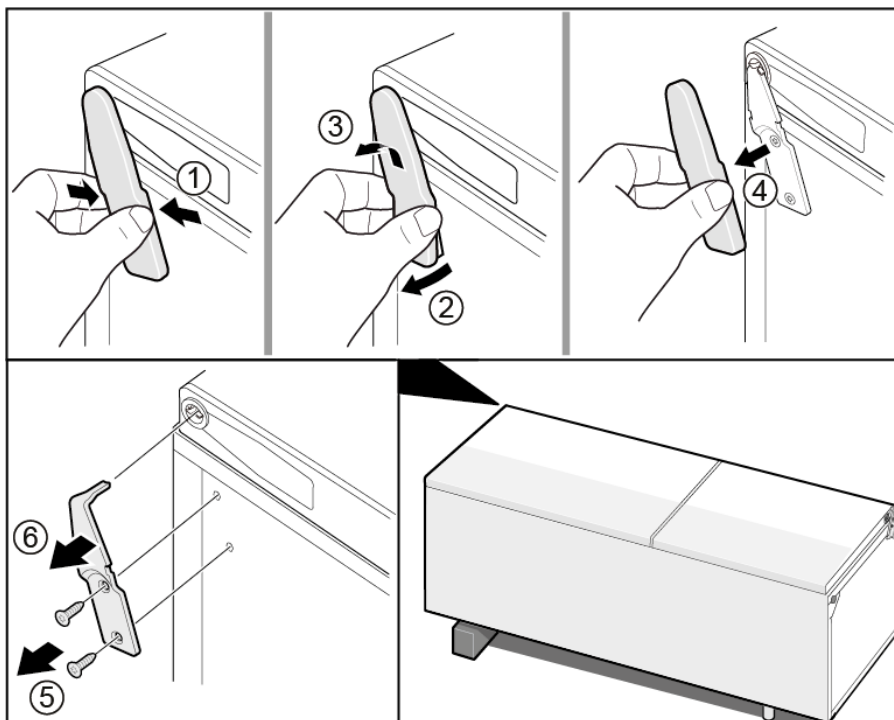

 Horní závěs je vyjmutý.

4.3.2 Montáž horního závěsu

- ▶ Montáž proveďte v opačném sledu.

4.4 Výměna horního závěsu dvířek (dvířka s ukazatelem)

Speciální nástroje:

 Torx Bit TX20 6,3 mm (1/4") [00340865]

	⚠ VÝSTRAHA
	<p>Těžké, objemné spotřebiče! Poranění zad a svalů</p> <ul style="list-style-type: none"> ▶ Odstranění dvířek spotřebiče by měl provádět výhradně školený odborník. ▶ Pro manipulaci se spotřebičem jsou nutní dva lidé. ▶ Použijte pouze vhodné nástroje a zařízení.

	⚠ POZOR
	<p>Ostré hrany! Nebezpečí řezných poranění</p> <ul style="list-style-type: none"> ▶ Používejte ochranné rukavice.

	⚠ VÝSTRAHA
	<p>Sklouznutí nakloněných spotřebičů! Zlomeniny / poranění rozdrcením</p> <ul style="list-style-type: none"> ▶ Zajistěte spotřebiče proti sklouznutí.



	⚠ POZOR
	<p>Nebezpečí padajících dílů kvůli uvolněným šroubům! Poranění padajícími díly.</p> <ul style="list-style-type: none"> ▶ Zajistěte jednotlivé součásti před pádem.

	POZOR!
	<p>Nebezpečí padajících dílů kvůli uvolněným šroubům! Poškození jiných částí spotřebiče nebo prvků domácnosti zákazníka, např. podlahy.</p> <ul style="list-style-type: none"> ▶ Zajistěte jednotlivé součásti před pádem.

	⚠ NEBEZPEČÍ
	<p>Nebezpečí úrazu elektrickým proudem při dotyku dílů pod proudem! V případě neodborné opravy hrozí nebezpečí smrtelného úrazu elektrickým proudem</p> <ul style="list-style-type: none"> ▶ Opravu elektrického zařízení smí provádět jen kvalifikovaný elektrikář. ▶ Po opravě nechte provést bezpečnostní zkoušku podle VDE 0701 nebo specifických předpisů dané země.

	⚠ NEBEZPEČÍ
	<p>Nebezpečí úrazu elektrickým proudem při dotyku dílů pod proudem! Usmrcení elektrickým proudem</p> <ul style="list-style-type: none"> ▶ Odpojte spotřebič od přívodu elektrického proudu alespoň 60 sekund před zahájením opravy.

Požadavek:

-  Spotřebič je odpojený od přívodu elektrické energie.
-  Vnitřní kování spotřebiče je odstraněno.

4.4.1 Vyjmutí horního závěsu dvířek

1. Položte spotřebič na zadní stranu.

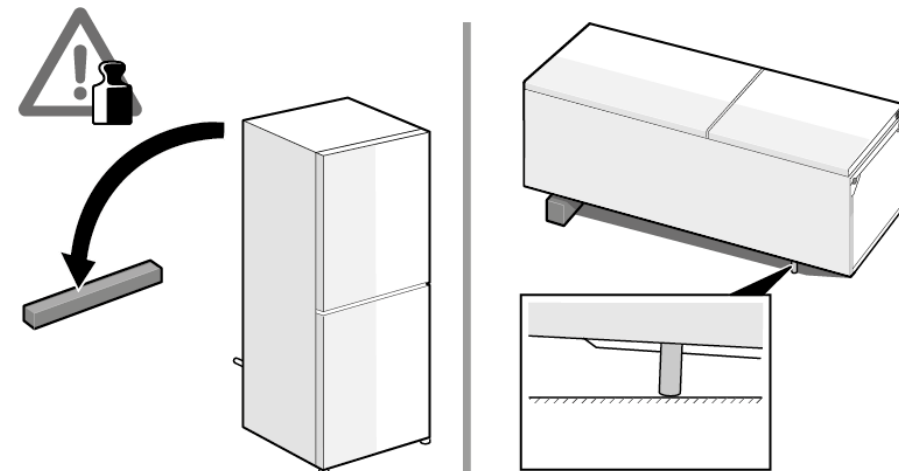

2. 1. Odstraňte kryt horního závěsu (1).
2. Odstraňte kryt kabelové skříně (2).
3. Odpojte elektrické připojení (3).
4. Vyšroubujte šroub zemnicí přípojky (4).
5. Odstraňte ochranu kabelu (5).
6. Vyšroubujte šroub (6).

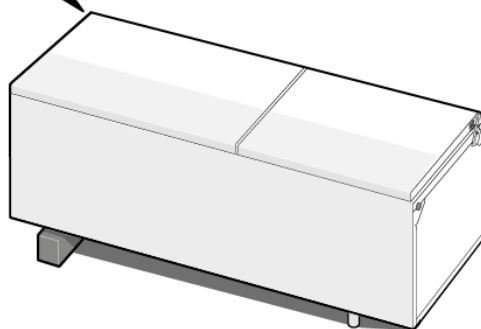
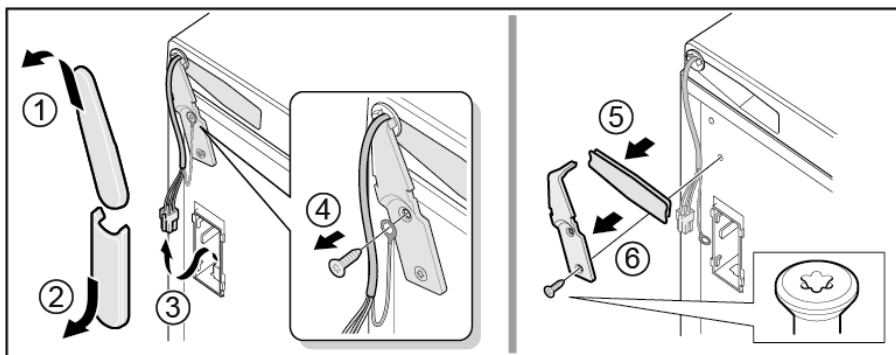

 Horní závěs je vyjmutý.

4.4.2 Montáž horního závěsu

- ▶ Montáž provedte v opačném sledu.

4.5 Výměna středního závěsu dvířek

Speciální nástroje:

 Torx Bit TX20 6,3 mm (1/4") [00340865]

	⚠ VÝSTRAHA
	<p>Těžké, objemné spotřebiče! Poranění zad a svalů</p> <ul style="list-style-type: none"> ▶ Odstranění dvířek spotřebiče by měl provádět výhradně školený odborník. ▶ Pro manipulaci se spotřebičem jsou nutní dva lidé. ▶ Použijte pouze vhodné nástroje a zařízení.



	⚠ POZOR
	<p>Ostré hrany! Nebezpečí řezných poranění</p> <ul style="list-style-type: none"> ▶ Používejte ochranné rukavice.

	⚠ VÝSTRAHA
	<p>Sklouznutí nakloněných spotřebičů! Zlomeniny / poranění rozdrcením</p> <ul style="list-style-type: none"> ▶ Zajistěte spotřebiče proti sklouznutí.

	⚠ POZOR
	<p>Nebezpečí padajících dílů kvůli uvolněným šroubům! Poranění padajícími díly.</p> <ul style="list-style-type: none"> ▶ Zajistěte jednotlivé součásti před pádem.

	POZOR!
	<p>Nebezpečí padajících dílů kvůli uvolněným šroubům! Poškození jiných částí spotřebiče nebo prvků domácnosti zákazníka, např. podlahy.</p> <ul style="list-style-type: none"> ▶ Zajistěte jednotlivé součásti před pádem.

Požadavek:

-  Spotřebič je odpojený od přívodu elektrické energie.
-  Vnitřní kování spotřebiče je odstraněno.
-  Horní závěs dvířek je vyjmutý.

4.5.1 Vyjmutí středního závěsu dvířek

- ▶ 1. Vyjměte dvířka chladicí přihrádky (1).
- ▶ 2. Vyšroubujte dva šrouby (2).
- ▶ 3. Vyjměte střední závěs (3).

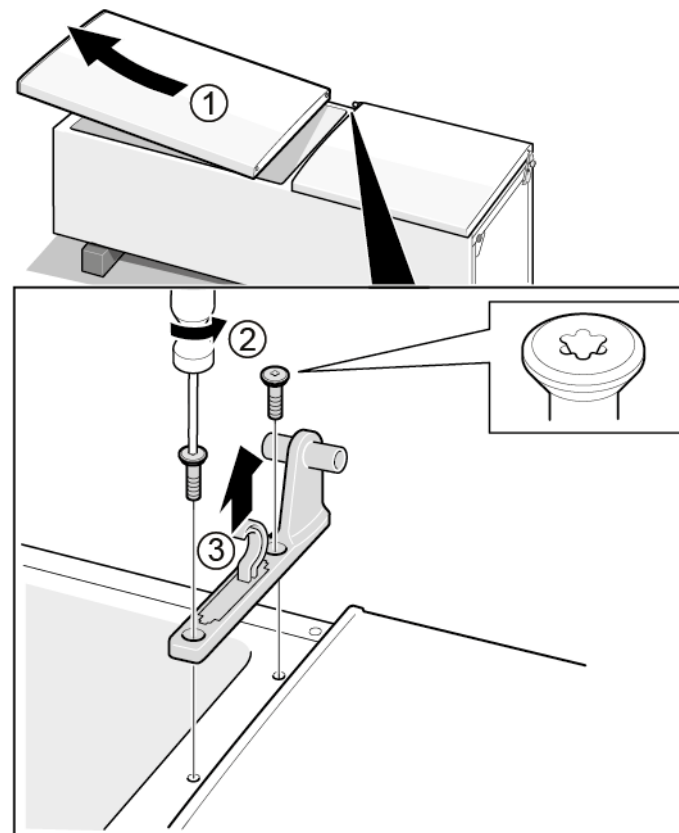

 Střední závěs je vyjmutý.

4.5.2 Montáž středního závěsu dvířek

- ▶ Montáž proveďte v opačném sledu.

4.6 Výměna dolního závěsu dvířek

Speciální nástroje:

Torx Bit TX20 6,3 mm (1/4") [00340865]

	VÝSTRAHA
	<p>Těžké, objemné spotřebiče! Poranění zad a svalů</p> <ul style="list-style-type: none"> ▶ Odstranění dvířek spotřebiče by měl provádět výhradně školený odborník. ▶ Pro manipulaci se spotřebičem jsou nutní dva lidé. ▶ Použijte pouze vhodné nástroje a zařízení.

	POZOR
	<p>Ostré hrany! Nebezpečí řezných poranění</p> <ul style="list-style-type: none"> ▶ Používejte ochranné rukavice.

	VÝSTRAHA
	<p>Sklouznutí nakloněných spotřebičů! Zlomeniny / poranění rozdrcením</p> <ul style="list-style-type: none"> ▶ Zajistěte spotřebiče proti sklouznutí.

	POZOR
	<p>Nebezpečí padajících dílů kvůli uvolněným šroubům! Poranění padajícími díly.</p> <ul style="list-style-type: none"> ▶ Zajistěte jednotlivé součásti před pádem.

	POZOR!
	<p>Nebezpečí padajících dílů kvůli uvolněným šroubům! Poškození jiných částí spotřebiče nebo prvků domácnosti zákazníka, např. podlahy.</p> <ul style="list-style-type: none"> ▶ Zajistěte jednotlivé součásti před pádem.

Požadavek:

- ✔ Spotřebič je odpojený od přívodu elektrické energie.
- ✔ Vnitřní kování spotřebiče je odstraněno.
- ✔ Horní závěs je vyjmutý.

✔ Střední závěs je vyjmutý.

4.6.1 Vyjmutí spodního závěsu dvířek

- ▶ 1. Vyjměte dvířka mrazicí přihrádky (1).
- ▶ 2. Vyšroubujte šrouby (2).
- ▶ 3. Vytočte spodní závěs (3).
- ▶ 4. Vyjměte spodní závěs (4).

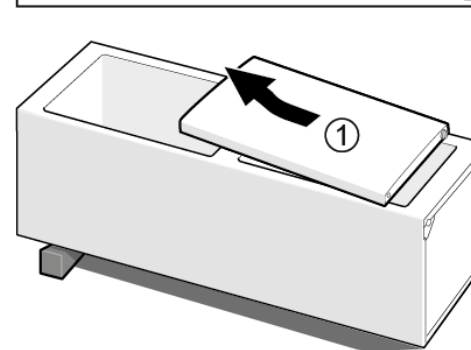
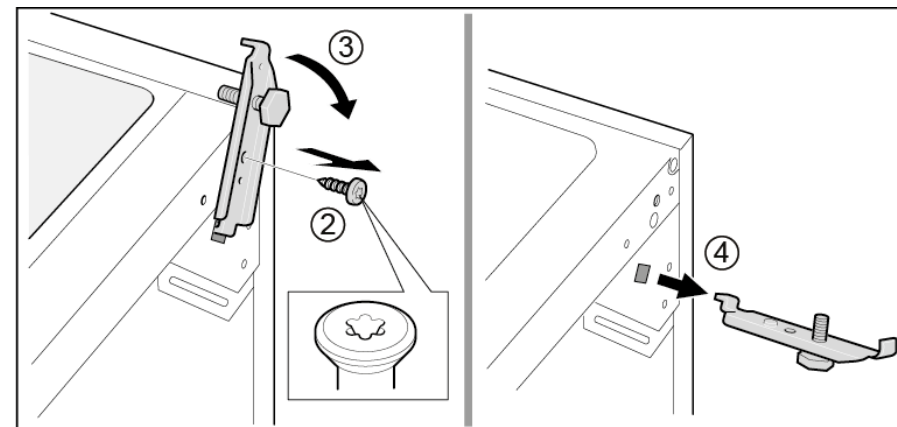

➡ Spodní závěs dvířek je vyjmutý.

4.6.2 Montáž spodního závěsu dvířek

- ▶ Montáž proveďte v opačném sledu.

4.7 Výměna odkládací plochy

Požadavek:

- ✔ Dvířka jsou otevřená.

4.7.1 Vyjmutí odkládací plochy

- ▶ Vytáhněte odkládací plochu.

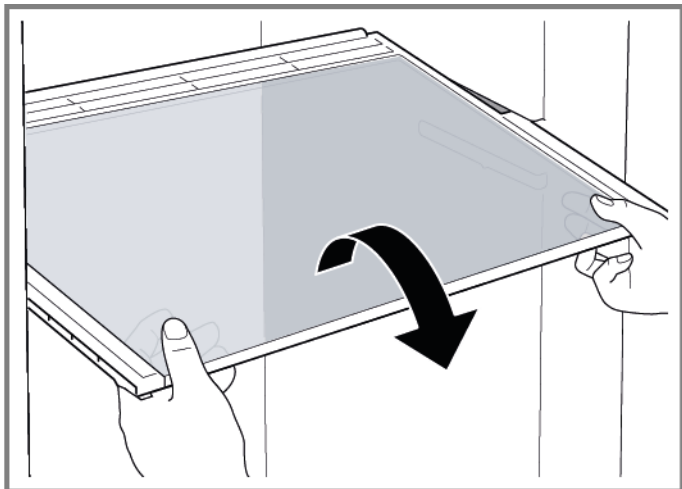

- ➡ Odkládací plocha je vyjmutá.

4.7.2 Montáž odkládací plochy

- ▶ Montáž proveďte v opačném sledu.

4.8 Výměna držáku na láhve

Požadavek:

- ✔ Dvířka jsou otevřená.

4.8.1 Vyjmutí držáku na láhve

- ▶ Vytáhněte držák na láhve.

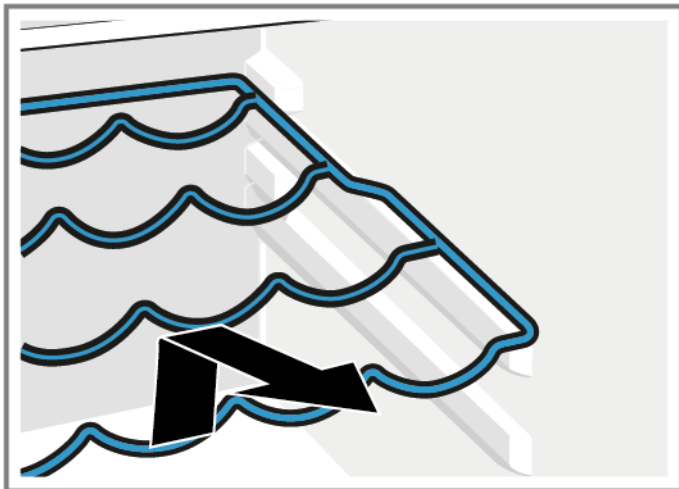

- ➡ Držák na láhve je vyjmutý.

4.8.2 Montáž držáku na láhve

- ▶ Montáž provedte v opačném sledu.

4.9 Výměna dveřní přihrádky

Požadavek:

- ✔ Dvířka jsou otevřená.

4.9.1 Vyjmutí dveřní přihrádky

- ▶ Zvedněte dveřní přihrádku nahoru.

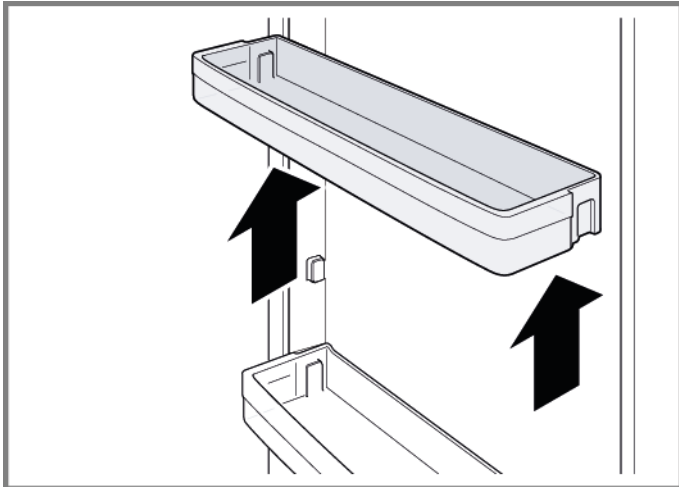

- ➡ Dveřní přihrádka je vyjmutá.

4.9.2 Montáž dveřní přihrádky

- ▶ Montáž proveďte v opačném sledu.

4.10 Výměna nastavitelné dveřní přihrádky

Požadavek:

- ✔ Dvířka jsou otevřená.

4.10.1 Vyjmutí nastavitelné dveřní přihrádky

- ▶ Posuňte výškově stavitelnou dveřní přihrádku nahoru, aby se uvolnila z držáku.

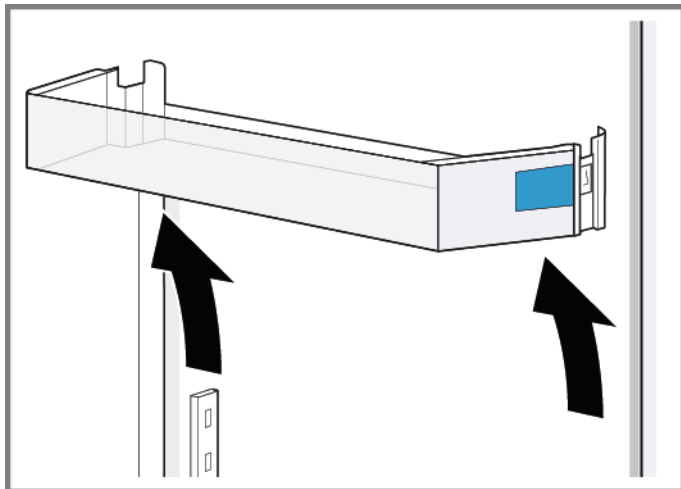

- ➡ Nastavitelná dveřní přihrádka je vyjmutá.

4.10.2 Montáž nastavitelné dveřní přihrádky

- ▶ Montáž proveďte v opačném sledu.

4.11 Výměna zásobníku na zmrazené potraviny

Požadavek:

- ✔ Dvířka jsou otevřená.

4.11.1 Vyjmutí zásobníku na zmrazené potraviny

- ▶ 1. Úplně vytáhněte zásobník na zmrazené potraviny (1).
- ▶ 2. Vyjměte zásobník na potraviny (2).

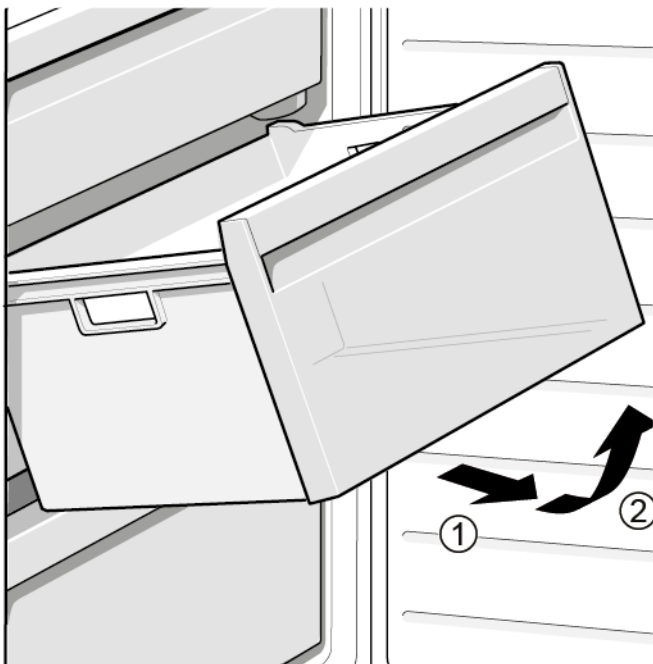

- ➡ Zásobník na zmrazené potraviny je vyjmutý.

4.11.2 Montáž zásobníku na zmrazené potraviny

- ▶ Montáž proveďte v opačném sledu.

4.12 Výměna zásobníku

Požadavek:

- ✔ Dvířka jsou otevřená.

4.12.1 Vyjmutí zásobníku

- ▶ 1. Vytáhněte spodní zásobník chladničky (1).
- ▶ 2. Vytáhněte horní zásobník chladničky (2).

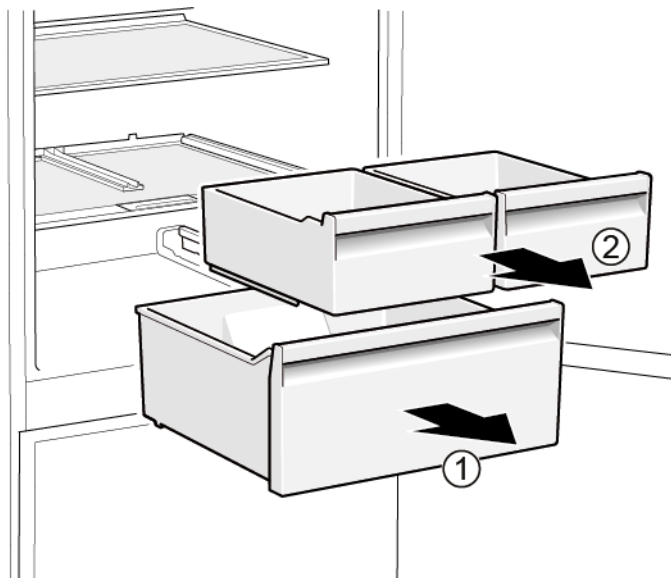

- ➡ Zásobníky jsou vyjmuté.

4.12.2 Montáž zásobníku

- ▶ Montáž proveďte v opačném sledu.

4.13 Výměna výsuvného zásobníku

Požadavek:

- ✔ Dvířka jsou otevřená.

4.13.1 Vyjmutí výsuvného zásobníku

- ▶ 1. Úplně vytáhněte výsuvný zásobník (1).
- ▶ 2. Vyjměte výsuvný zásobník (2).

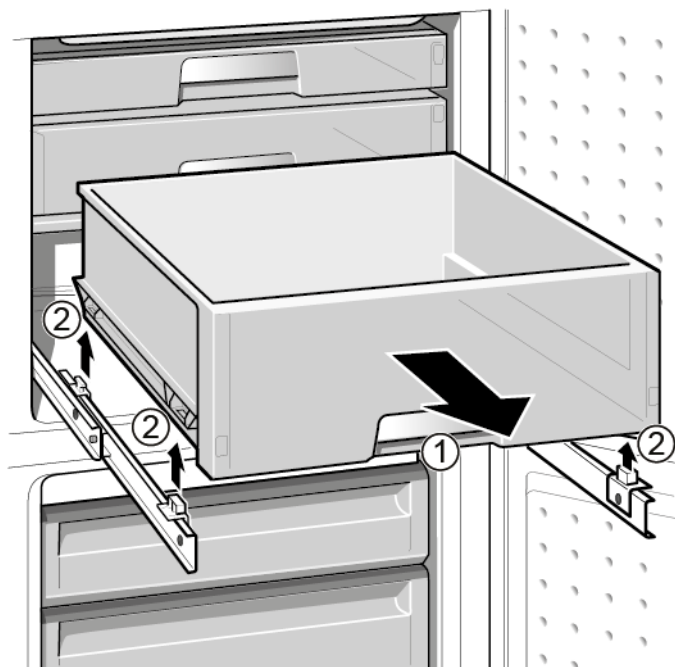

- ➡ Výsuvný zásobník je vyjmutý.

4.13.2 Montáž výsuvného zásobníku

- ▶ Montáž proveďte v opačném sledu.

4.14 Výměna LED bodového osvětlení

Speciální nástroje:

 Speciální nástroj [00342180]

 Váš spotřebič je vybaven bezúdržbovým LED osvětlením. Tato osvětlení smí být opravena pouze zákaznickým servisem nebo oprávněným technikem!

 **NEBEZPEČÍ**
Nebezpečí úrazu elektrickým proudem při dotyku dílů pod proudem!
 V případě neodborné opravy hrozí nebezpečí smrtelného úrazu elektrickým proudem

- ▶ Opravu elektrického zařízení smí provádět jen kvalifikovaný elektrikář.
- ▶ Po opravě nechte provést bezpečnostní zkoušku podle VDE 0701 nebo specifických předpisů dané země.



 **NEBEZPEČÍ**
Nebezpečí úrazu elektrickým proudem při dotyku dílů pod proudem!
 Usmrcení elektrickým proudem

- ▶ Odpojte spotřebič od přívodu elektrického proudu alespoň 60 sekund před zahájením opravy.

 **POZOR**
Ostré hrany!
 Nebezpečí řezných poranění

- ▶ Používejte ochranné rukavice.

Požadavek:

-  Spotřebič je odpojený od přívodu elektrické energie.
-  Dvířka jsou otevřená.

4.14.1 Vyjmutí LED bodového osvětlení

- Pro vytažení LED bodového osvětlení použijte speciální nástroj (1).

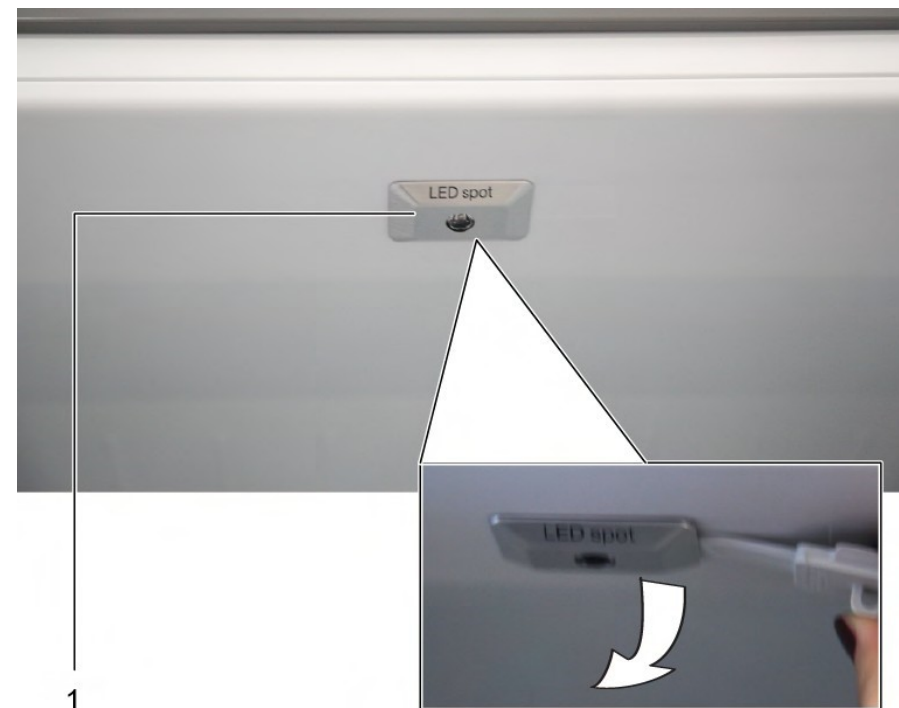

- Odpojte elektrické připojení LED bodového osvětlení.
-  LED bodové osvětlení je vyjmuté.

4.14.2 Montáž LED bodového osvětlení

- ▶ Montáž proveďte v opačném sledu.

4.15 Výměna LED horního osvětlení

Speciální nástroje:

-  Plochý šroubovák
-  Čepel 2,4 mm x 0,4 mm x 60 mm, v sadě [00341820]



Váš spotřebič je vybaven bezúdržbovým LED osvětlením. Tato osvětlení smí být opravena pouze zákaznickým servisem nebo oprávněným technikem!



NEBEZPEČÍ

Nebezpečí úrazu elektrickým proudem při dotyku dílů pod proudem!
V případě neodborné opravy hrozí nebezpečí smrtelného úrazu elektrickým proudem

- ▶ Opravu elektrického zařízení smí provádět jen kvalifikovaný elektrikář.
- ▶ Po opravě nechte provést bezpečnostní zkoušku podle VDE 0701 nebo specifických předpisů dané země.



NEBEZPEČÍ

Nebezpečí úrazu elektrickým proudem při dotyku dílů pod proudem!
Usmrcení elektrickým proudem

- ▶ Odpojte spotřebič od přívodu elektrického proudu alespoň 60 sekund před zahájením opravy.





POZOR

Ostré hrany!
Nebezpečí řezných poranění

- ▶ Používejte ochranné rukavice.

Požadavek:

-  Spotřebič je odpojený od přívodu elektrické energie.
-  Dvířka jsou otevřená.
-  Horní vnitřní kování je vyjmuto.

4.15.1 Vyjmutí LED osvětlení

1. Posuňte LED osvětlení k levé straně.

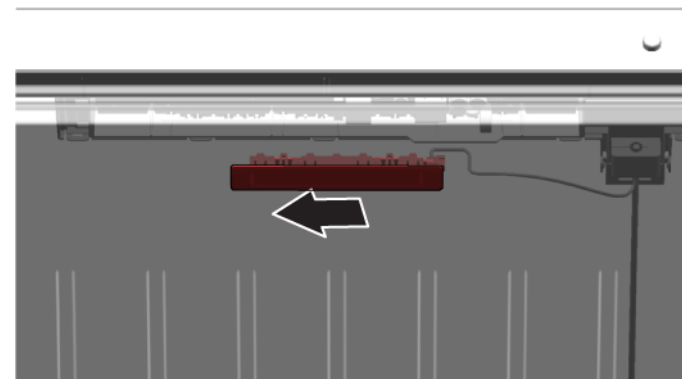

-  Elektrické připojení LED osvětlení je odpojené.

2. Uvolněte háky LED osvětlení.



3. Odstraňte LED osvětlení jeho posunutím dopředu.

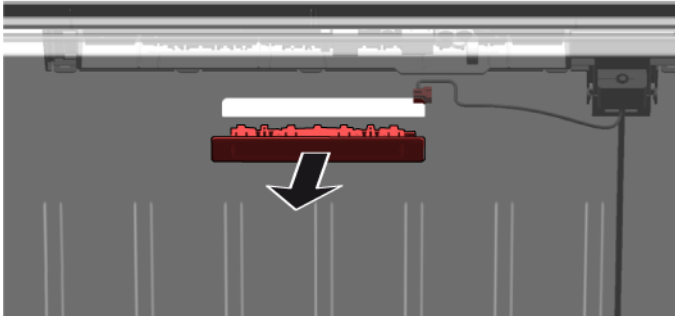

- ➔ LED osvětlení je vyjmuté.

4.15.2 Montáž horního LED osvětlení

- ▶ Montáž proveďte v opačném sledu.

4.16 Výměna LED osvětlení boční lišty

Speciální nástroje:

 Přísavka Ø50 mm [00342224]



Váš spotřebič je vybaven bezúdržbovým LED osvětlením. Tato osvětlení smí být opravena pouze zákaznickým servisem nebo oprávněným technikem!



NEBEZPEČÍ

Nebezpečí úrazu elektrickým proudem při dotyku dílů pod proudem!
V případě neodborné opravy hrozí nebezpečí smrtelného úrazu elektrickým proudem

- ▶ Opravu elektrického zařízení smí provádět jen kvalifikovaný elektrikář.
- ▶ Po opravě nechte provést bezpečnostní zkoušku podle VDE 0701 nebo specifických předpisů dané země.



NEBEZPEČÍ

Nebezpečí úrazu elektrickým proudem při dotyku dílů pod proudem!
Usmrcení elektrickým proudem

- ▶ Odpojte spotřebič od přívodu elektrického proudu alespoň 60 sekund před zahájením opravy.





POZOR

Ostré hrany!

Nebezpečí řezných poranění

- ▶ Používejte ochranné rukavice.

Požadavek:

-  Spotřebič je odpojený od přívodu elektrické energie.
-  Dvířka jsou otevřená.
-  Odkládací plochy chladicí přihrádky jsou vyjmuté.

4.16.1 Vyjmutí LED osvětlení boční lišty

1. Přilepte přísavku na horní třetinu LED boční lišty.



2. Otočením vytáhněte dopředu přísavku s LED osvětlením boční lišty.

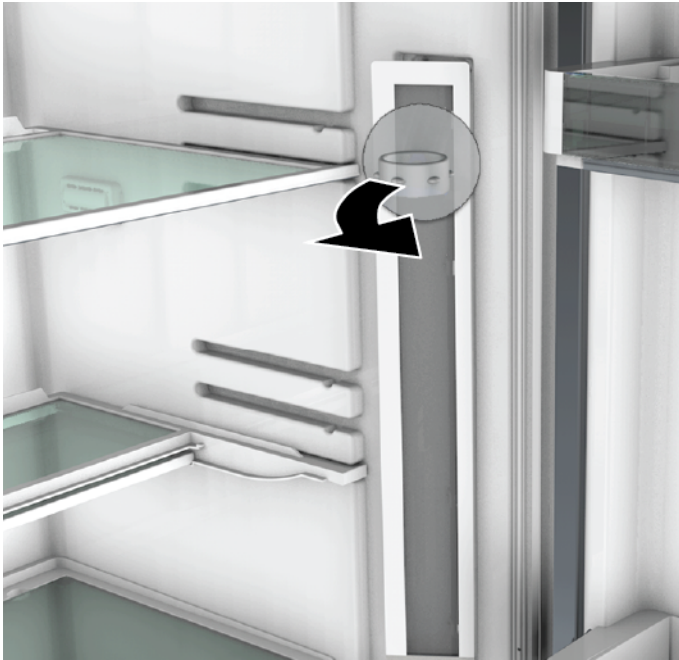



3. Odpojte elektrické připojení LED osvětlení boční lišty.
➡ LED osvětlení boční lišty je vyjmuté.

4.16.2 Montáž LED osvětlení boční lišty

1. Zapojte elektrické připojení LED osvětlení boční lišty.
 2. Upevněte LED osvětlení boční lišty na své místo ve stěně přihrádky (háky musí zaklapnout).
- ➡ LED osvětlení boční lišty je namontované.

4.17 Výměna LED bodového osvětlení

Speciální nástroje:

-  Speciální nástroj [00342180]
-  Plochý šroubovák Čepel 2,4 mm x 0,4 mm x 60 mm, v sadě [00341820]

 Váš spotřebič je vybaven bezúdržbovým LED osvětlením. Tato osvětlení smí být opravena pouze zákaznickým servisem nebo oprávněným technikem!

 **NEBEZPEČÍ**
Nebezpečí úrazu elektrickým proudem při dotyku dílů pod proudem!
 V případě neodborné opravy hrozí nebezpečí smrtelného úrazu elektrickým proudem

- ▶ Opravu elektrického zařízení smí provádět jen kvalifikovaný elektrikář.
- ▶ Po opravě nechte provést bezpečnostní zkoušku podle VDE 0701 nebo specifických předpisů dané země.



 **NEBEZPEČÍ**
Nebezpečí úrazu elektrickým proudem při dotyku dílů pod proudem!
 Usmrcení elektrickým proudem

- ▶ Odpojte spotřebič od přívodu elektrického proudu alespoň 60 sekund před zahájením opravy.

 **POZOR**
Ostré hrany!
 Nebezpečí řezných poranění

- ▶ Používejte ochranné rukavice.

Požadavek:

-  Spotřebič je odpojený od přívodu elektrické energie.
-  Dvířka jsou otevřená.
-  Odkládací plochy chladičů přihrádky jsou vyjmuté.

4.17.1 Vyjmutí LED bodového osvětlení

1. Uvolněte kryt LED bodového osvětlení.

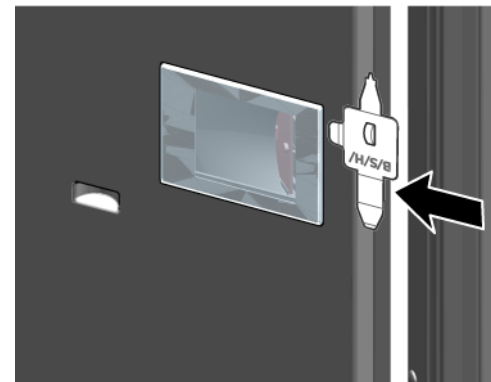

2. Zatáhněte kryt LED bodového světla dovnitř a současně jej vytlačte dopředu.

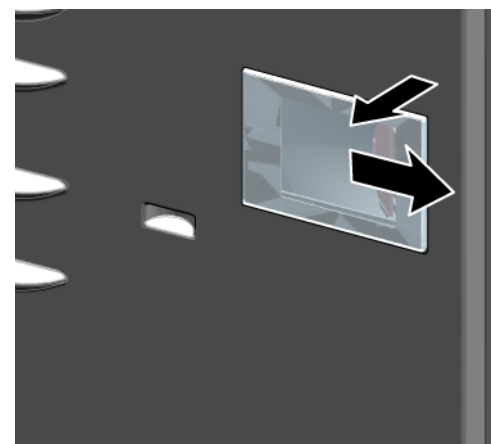

3. Odpojte modul LED bodového osvětlení.

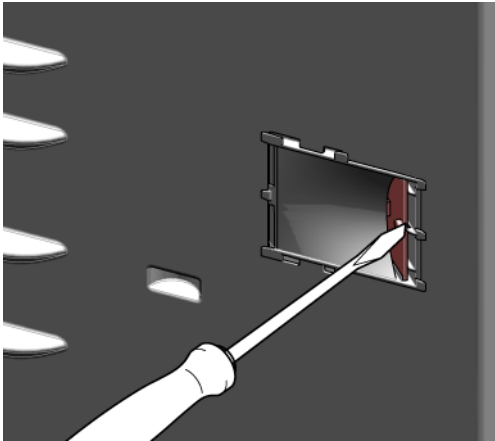

4. Odpojte elektrické připojení LED bodového osvětlení.

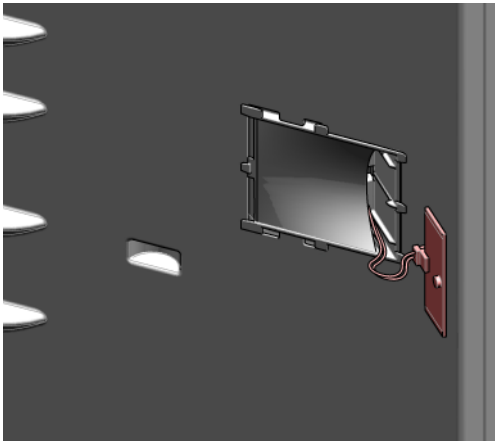





 LED bodové osvětlení je vyjmuté.

4.17.2 Montáž LED bodového osvětlení

- ▶ Montáž provedte v opačném sledu.

Tip til reparation - Køle-/ frysekombination

 Om dette dokument	90
1.1 Vigtig information.....	90
1.1.1 Formål.....	90
1.2 Forklaring af symboler	90
1.2.1 Fareniveauer	90
1.2.2 Faresymboler.....	90
1.2.3 Advarslernes opbygning	91
1.2.4 Generelle symboler	91
 Sikkerhed	92
2.1 Generelle sikkerhedsanvisninger	92
2.1.1 Alle husholdningsapparater	92
 Værktøjer og hjælpemidler	93
 Reparation	94
4.1 Udskiftning af dørpakning.....	94
4.1.1 Fjernelse af dørpakning.....	94
4.1.2 Montering af dørpakning.....	94
4.2 Udskiftning af dørhåndtag	97
4.2.1 Fjernelse af dørhåndtag	97
4.2.2 Montering af dørhåndtag	97
4.3 Udskiftning af øverste dørhængsel	98
4.3.1 Fjernelse af øverste dørhængsel.....	98
4.3.2 Montering af øverste dørhængsel	99
4.4 Udskiftning af det øverste dørhængsel (dør med display).....	100
4.4.1 Fjernelse af øverste dørhængsel.....	100
4.4.2 Montering af øverste dørhængsel	101
4.5 Udskiftning af midterste dørhængsel.....	102
4.5.1 Fjernelse af midterste dørhængsel	102
4.5.2 Montering af midterste dørhængsel.....	102
4.6 Udskiftning af nederste dørhængsel	103
4.6.1 Fjernelse af nederste dørhængsel.....	103
4.6.2 Montering af nederste dørhængsel.....	103
4.7 Udskiftning af hylde	104
4.7.1 Fjernelse af hylde.....	104
4.7.2 Montering af hylde	104

4.8 Udskiftning af flaskehylde	105
4.8.1 Fjernelse af flaskehylde	105
4.8.2 Montering af flaskehylde	105
4.9 Udskiftning af dørhylde.....	106
4.9.1 Fjernelse af dørhylde	106
4.9.2 Montering af dørhylde	106
4.10 Udskiftning af justerbar dørhylde.....	107
4.10.1 Fjernelse af justerbar dørhylde	107
4.10.2 Montering af justerbar dørhylde	107
4.11 Udskiftning af frostvarebeholder.....	108
4.11.1 Fjernelse af frostvarebeholder	108
4.11.2 Montering af frostvarebeholder	108
4.12 Udskiftning af beholder.....	109
4.12.1 Fjernelse af beholder	109
4.12.2 Montering af beholder	109
4.13 Udskiftning af udtrækkelig beholder	110
4.13.1 Fjernelse af udtrækkelig beholder	110
4.13.2 Montering af udtrækkelig beholder.....	110
4.14 Udskiftning af LED-spotlampe.....	111
4.14.1 Fjernelse af LED-spotlampe	111
4.14.2 Montering af LED-spotlampe	111
4.15 Udskiftning af LED-lampe foroven.....	112
4.15.1 Fjernelse af LED-lampe	112
4.15.2 Montering af LED-lampe foroven	113
4.16 Udskiftning af LED-sidebjælkelampe	114
4.16.1 Fjernelse LED-sidebjælkelampe	114
4.16.2 Montering af LED-sidebjælkelampe	115
4.17 Udskiftning af LED-spotlampe.....	116
4.17.1 Fjernelse af LED-spotlampe	116
4.17.2 Montering af LED-spotlampe.....	117

i Om dette dokument

1.1 Vigtig information

1.1.1 Formål

Disse reparationsanvisninger hjælper kunden til selv at kunne reparere apparater i henhold til den gældende lovgivning om miljøvenligt design (fra 03/2021).





De indeholder information om, hvordan der udskiftes bestemte reservedele, herunder advarsler og risici.

Kontakt kundeservice i tilfælde af spørgsmål. Vi påtager os kun ansvar for skader, hvis reparationsanvisningerne er fuldt korrekt.

1.2 Forklaring af symboler

1.2.1 Fareniveauer

Advarselsniveauerne består af et symbol og et signalford. Signalfordene indikerer farens alvor.





Advarselsniveau	Betydning
	Manglende overholdelse af advarselsmeddelelsen vil medføre død eller alvorlige kvæstelser.
	Manglende overholdelse af advarselsmeddelelsen kan medføre død eller alvorlige kvæstelser.
	Manglende overholdelse af advarselsmeddelelsen kan medføre mindre kvæstelser.
	Manglende overholdelse af advarselsmeddelelsen kan medføre materiel beskadigelse.

Tabel 1: Fareniveauer





1.2.2 Faresymboler

Faresymboler er symbolske visninger, der giver en indikation af faretypen.

Der anvendes følgende faresymboler i dette dokument:

Faresymbol	Betydning
	Generel advarselsmeddelelse
	Fare for elektrisk spænding
	Eksplussionsfare
	Fare for at skære sig

i Om dette dokument

Faresymbol	Betydning
	Fare for klemning
	Fare pga. varme overflader
	Fare pga. kraftigt magnetfelt
	Fare pga. ikke-ioniserende stråling

Tabel 2: Faresymboler

1.2.3 Advarslernes opbygning

Advarsler i dette dokument har et standardiseret udseende og en standardiseret opbygning.

	<p>FARE</p> <p>Farens type og kilde! Mulige følger, hvis faren/advarslen ignoreres.</p> <ul style="list-style-type: none"> ▶ Foranstaltninger og forbud for at forhindre faren.
--	---

De følgende eksempler viser en advarsel, der advarer mod elektrisk stød pga. spændingsførende dele. Foranstaltningen til at undgå faren er nævnt.

	<p>FARE</p> <p>Fare for elektrisk stød pga. spændingsførende dele! Død ved elektrisk stød</p> <ul style="list-style-type: none"> ▶ Afbryd apparater fra strømforsyningen i mindst 60 sekunder, før reparationer påbegyndes.
--	---

1.2.4 Generelle symboler

Der anvendes følgende generelle symboler i dette dokument:

Generelt symbol	Betydning
	Angivelse af et særligt tip (tekst og/eller grafik)
	Angivelse af et simpelt tip (kun tekst)
	Angivelse af et link til en videotutorial
	Angivelse af nødvendige værktøjer
	Angivelse af krævede forudsætninger
	Angivelse af en betingelse (hvis..., så...)
	Angivelse af et resultat
	Angivelse af en tast eller knap
	Angivelse af et materialenummer
	Angivelse af en vist tekst/et vist vindue (i apparatets display)

Tabel 3: Generelle symboler

2.1 Generelle sikkerhedsanvisninger

2.1.1 Alle husholdningsapparater

Fare for elektrisk stød pga. spændingsførende dele!

- Fejl i forbindelse med reparationer, der involverer elektriske komponenter, kan medføre elektrisk stød!
- Afbryd apparatet fra strømnettet i mindst 60 sekunder, før arbejdet påbegyndes.
- Få efter reparationen udført en sikkerhedstest i henhold til VDE 0701 eller landespecifikke forskrifter.

Fare for tilskadekomst pga. skarpe kanter!

- Brug beskyttelseshandsker.

Fare for klemning i forbindelse med reparation, vedligeholdelse, fejlafhjælpning og service på grund af tunge og bevægelige komponenter

- Brug sikkerhedssko.
- Sørg for at sikre tunge komponenter mod at falde ned.
- Stik kropsdele ind i bevægelige komponenter.





Fare for apparatets sikkerhed/funktion!

- Brug kun originale reservedele.

Fare for beskadigelse af elektrostatisk følsomme komponenter (elektrostatiske afladninger)!

- Berør ikke modulerne, herunder forbindelser og ledningsbaner.

Værktøjer og hjælpemidler

Betegnelse	Detaljer	Billeder
Beskyttelsesklud [00342013]	60 cm x 50 cm	
Kærnskruetrækker	Blad 2,4 mm x 0,4 mm x 60 mm i sættet [00341820]	
Specialværktøj [00342180]		
Sugekop [00342224]	Ø50 mm	
Torx-bit TX20 [00340865]	6,3 mm (1/4")	
Kærnskruetrækker	Blad 10 mm x 1,6 mm x 200 mm	

4.1 Udskiftning af dørpakning

Preindstilling:

- ✔ Døren er åben.

4.1.1 Fjernelse af dørpakning

1. Frigør dørpakningen fra rillen i højre og venstre hjørne.



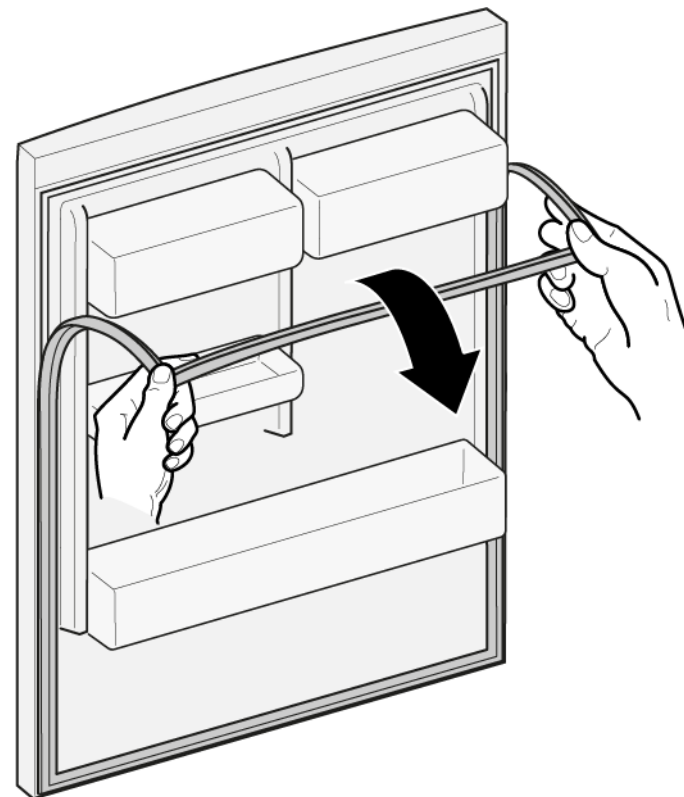

2. Træk dørpakningen ud af rillen.



- ➡ Dørpakningen er fjernet.

4.1.2 Montering af dørpakning

	Tykkelsen af den nye dørpakning kan afvige en smule fra tykkelsen af den gamle dørpakning. Dette vil ikke påvirke lukkemåden og den langsigtede funktion.
	Hvis apparatet har justerbare hængsler eller hængselbeslag, kan lukkemåden efterfølgende optimeres.
	Små sidehuller i dørpakningen er funktionelle (nødvendige til lufttilførelse). De er ikke produktionsfejl.

Reparation

1. Kontrollér rillen til pakningen med hensyn til beskadigelse.

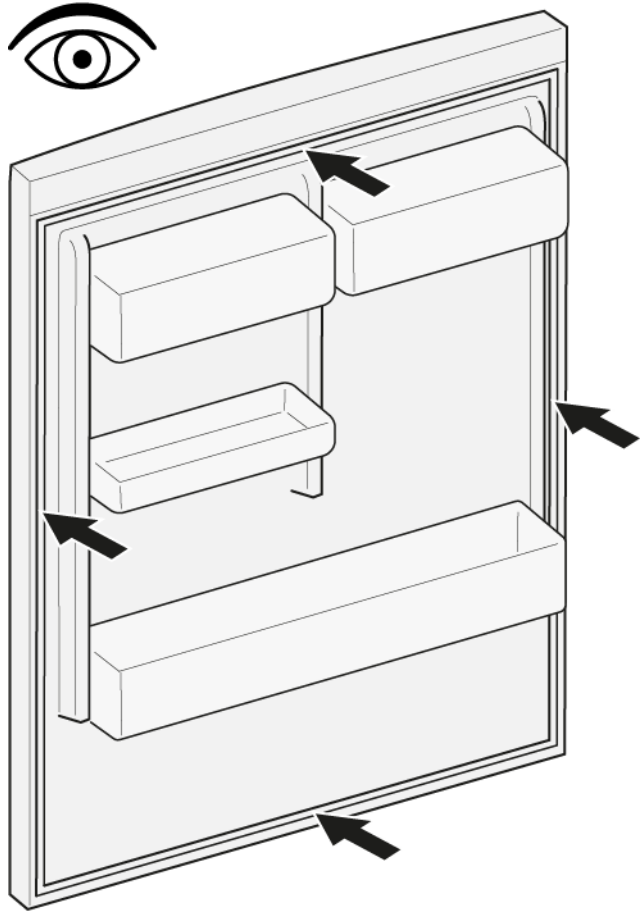

2.  Hvis rillen til pakningen er beskadiget:
 - Kontakt kundeservice.

3.  En smule deformation på dørpakningen er normalt og påvirker ikke dens funktion. Det anbefales til at glatte dørpakningen, før den sættes i apparatet.

Opvarm dørpakningen med en hårtørrer eller varmt vand, og genform den manuelt.

4. Tryk pakningens hjørner i rillen foroven og forneden.

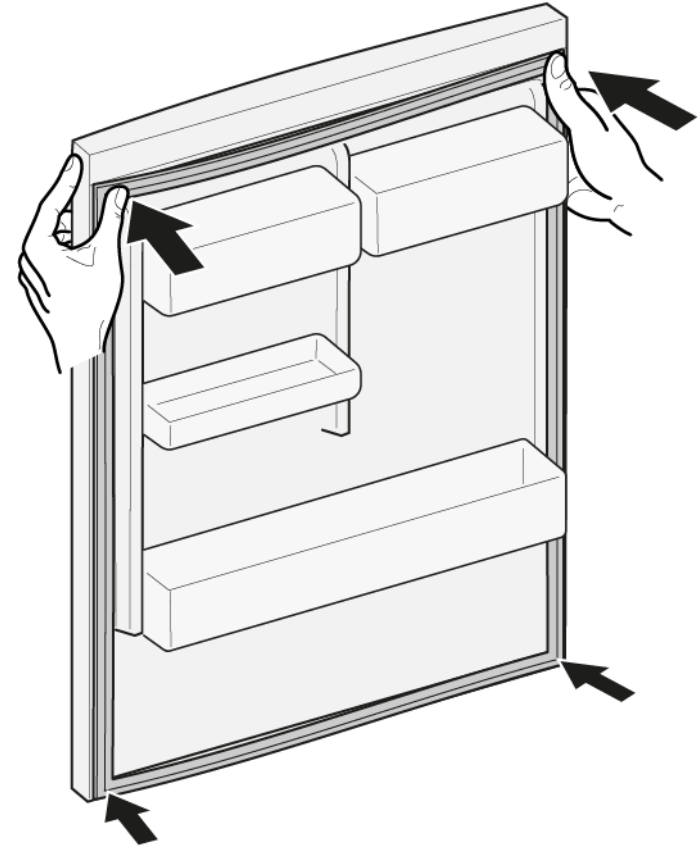

Reparation

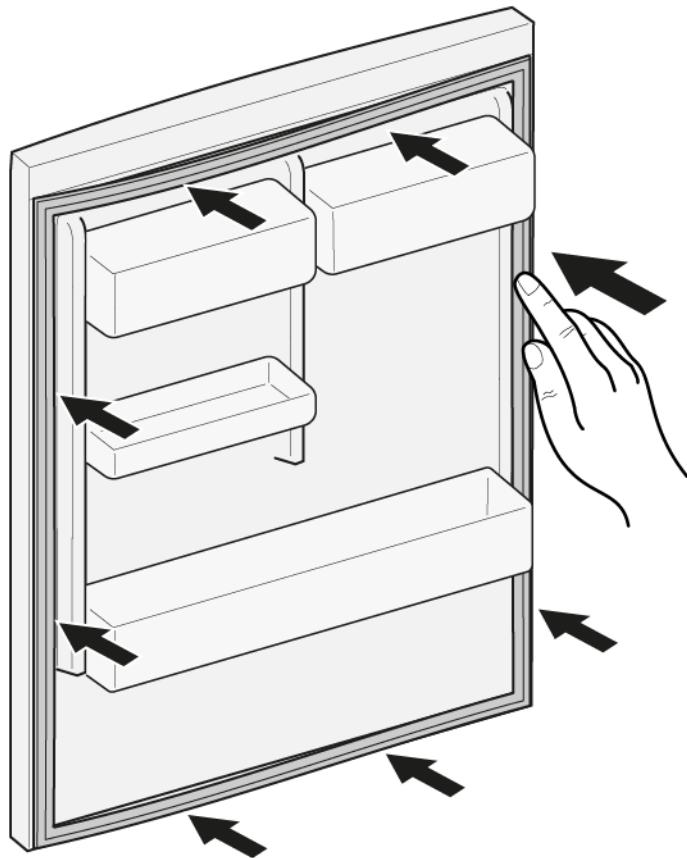

5. Tryk hele pakningen trinvist i rillen.





 Dørpakningen er monteret.

4.2 Udskiftning af dørhåndtag

Nødvendig værktøj:

-  Torx-bit TX20 6,3 mm (1/4") [00340865]
-  Kærviskruetrækker Blad 10 mm x 1,6 mm x 200 mm

Preindstilling:

-  Apparatet er afbrudt fra strømforsyningen.
-  Døren er åben.

4.2.1 Fjernelse af dørhåndtag

- ▶ 1. Fjern de to skruehætter (1).
- ▶ 2. Skru de to skruer ud (2).
- ▶ 3. Fjern dørhåndtaget (3).

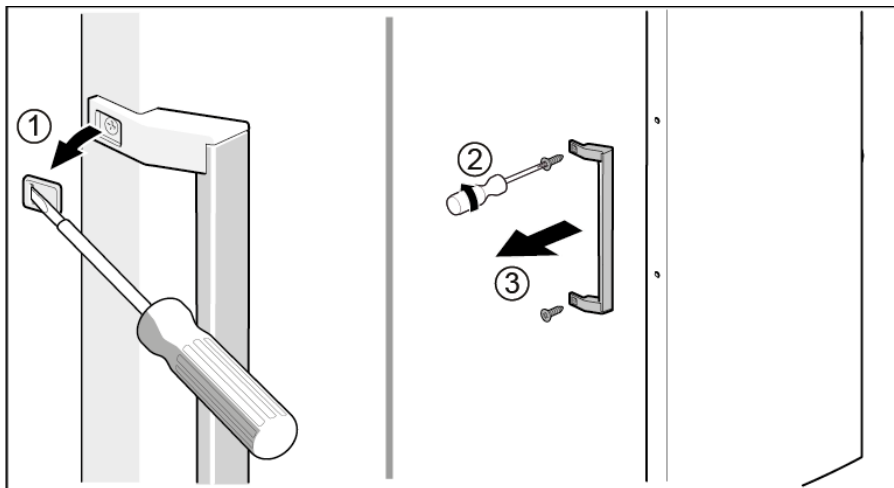

 Dørhåndtaget er fjernet.



Dørhåndtaget til den anden dør kan fjernes på samme måde.

4.2.2 Montering af dørhåndtag

- ▶ Montér i omvendt rækkefølge.





4.3 Udskiftning af øverste dørhængsel

Nødvendig værktøj:

🌀 Torx-bit TX20

6,3 mm (1/4")

[00340865]

	<p>⚠️ ADVARSEL</p> <p>Tunge, store apparater! Ryg- og muskelskader</p> <ul style="list-style-type: none">▶ Arbejde til fjernelse af apparatets dør bør kun udføres af uddannede specialister.▶ Der skal være to personer om at flytte apparatet.▶ Brug kun egnet værktøj og udstyr.
	<p>⚠️ PAS PÅ!</p> <p>Skarpe kanter! Snitlæsioner</p> <ul style="list-style-type: none">▶ Brug beskyttelseshandsker.
	<p>⚠️ ADVARSEL</p> <p>Apparater på skrå kan glide! Knoglebrud/klemskader</p> <ul style="list-style-type: none">▶ Sørg for at sikre apparater mod at glide.
	<p>⚠️ PAS PÅ!</p> <p>Fare for nedfaldende dele pga. løsnede skruer! Personskade pga. nedfaldende dele.</p> <ul style="list-style-type: none">▶ Sørg for at sikre komponenten mod at falde ned.
	<p>📌 BEMÆRK!</p> <p>Fare for nedfaldende dele pga. løsnede skruer! Beskadigelse af andre apparatdele eller kundens hjem, f.eks. gulvet.</p> <ul style="list-style-type: none">▶ Sørg for at sikre komponenten mod at falde ned.

Preindstilling:

- ✅ Apparatet er afbrudt fra strømforsyningen.
- ✅ Indvendigt tilbehør i apparatet er fjernet.

4.3.1 Fjernelse af øverste dørhængsel

1. Læg apparatet med bagsiden nedad.

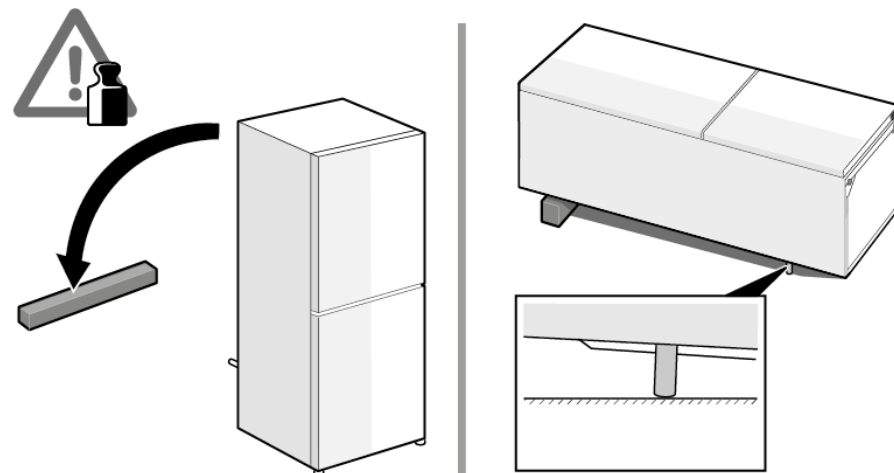

Reparation

2. 1. Tryk det øverste hængsels afdækning på begge sider (1).
2. Bevæg det øverste hængsels afdækning ud (2).
3. Drej hængslets afdækning (3).
4. Fjern det øverste hængsels afdækning (4).
5. Skru de to skruer ud (5).
6. Fjern det øverste hængsel (6).

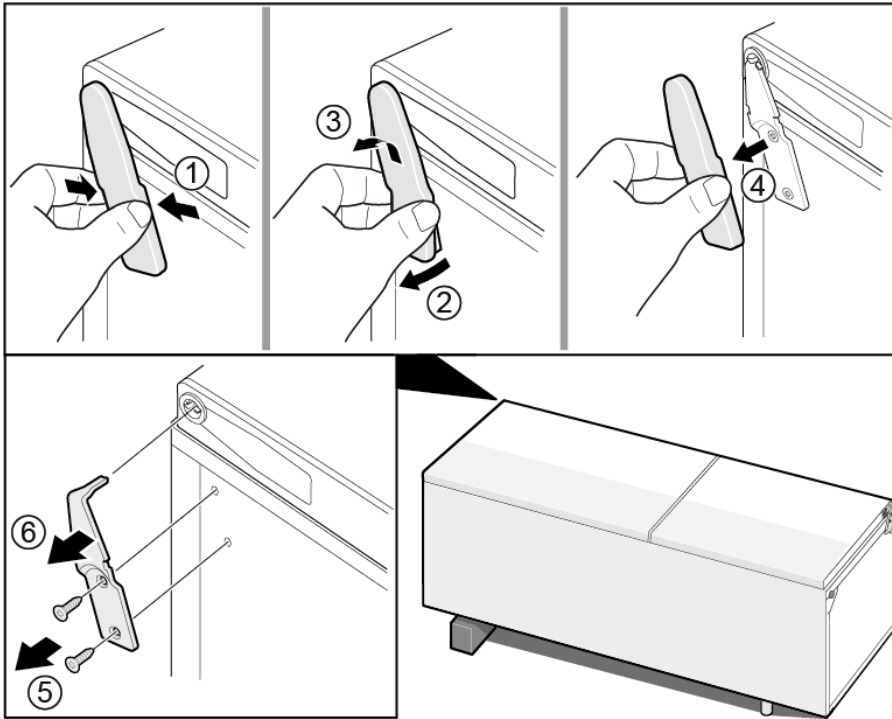

 Det øverste hængsel er fjernet.

4.3.2 Montering af øverste dørhængsel

- ▶ Montér i omvendt rækkefølge.

4.4 Udskiftning af det øverste dørhængsel (dør med display)

Nødvendig værktøj:

Torx-bit TX20 6,3 mm (1/4") [00340865]

	⚠ ADVARSEL
	<p>Tunge, store apparater! Ryg- og muskelskader</p> <ul style="list-style-type: none"> ▶ Arbejde til fjernelse af apparatets dør bør kun udføres af uddannede specialister. ▶ Der skal være to personer om at flytte apparatet. ▶ Brug kun egnet værktøj og udstyr.

	⚠ PAS PÅ!
	<p>Skarpe kanter! Snitlæsioner</p> <ul style="list-style-type: none"> ▶ Brug beskyttelseshandsker.

	⚠ ADVARSEL
	<p>Apparater på skrå kan glide! Knoglebrud/klemskader</p> <ul style="list-style-type: none"> ▶ Sørg for at sikre apparater mod at glide.

	⚠ PAS PÅ!
	<p>Fare for nedfaldende dele pga. løsnede skruer! Personskade pga. nedfaldende dele.</p> <ul style="list-style-type: none"> ▶ Sørg for at sikre komponenten mod at falde ned.

	BEMÆRK!
	<p>Fare for nedfaldende dele pga. løsnede skruer! Beskadigelse af andre apparatdele eller kundens hjem, f.eks. gulvet.</p> <ul style="list-style-type: none"> ▶ Sørg for at sikre komponenten mod at falde ned.

	⚠ FARE
	<p>Fare for elektrisk stød pga. spændingsførende dele! Livsfare pga. elektrisk stød i tilfælde af ukorrekt reparation</p> <ul style="list-style-type: none"> ▶ Elektriske dele skal repareres af kvalificerede elektrikere. ▶ Få efter reparationen udført en sikkerhedstest i henhold til VDE 0701 eller landespecifikke forskrifter.

	⚠ FARE
	<p>Fare for elektrisk stød pga. spændingsførende dele! Død ved elektrisk stød</p> <ul style="list-style-type: none"> ▶ Afbryd apparater fra strømforsyningen i mindst 60 sekunder, før reparationer påbegyndes.

Preindstilling:

- ✓ Apparatet er afbrudt fra strømforsyningen.
- ✓ Indvendigt tilbehør i apparatet er fjernet.

4.4.1 Fjernelse af øverste dørhængsel

1. Læg apparatet med bagsiden nedad.

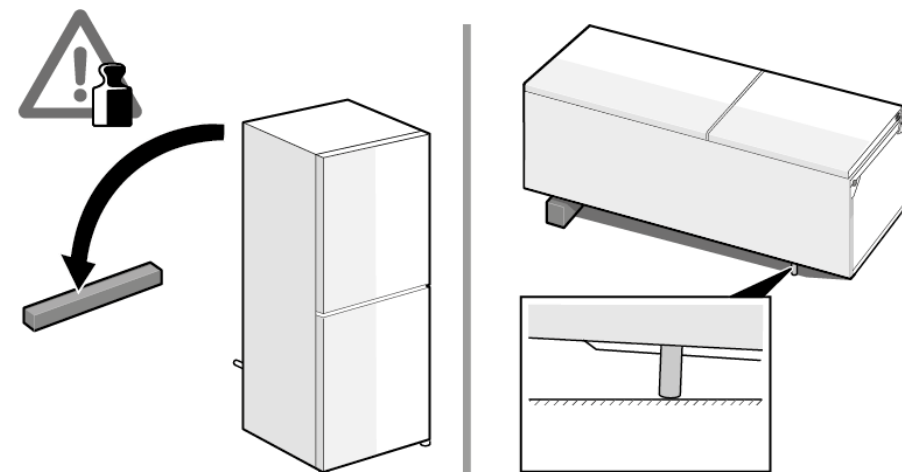

Reparation

2. 1. Fjern det øverste hængsels afdækning (1).
2. Fjern kabelboksens afdækning (2).
3. Afbryd den elektriske tilslutning (3).
4. Skru jordforbindelsesskruen ud (4).
5. Fjern kabelbeskyttelsen (5).
6. Skru skruen ud (6).

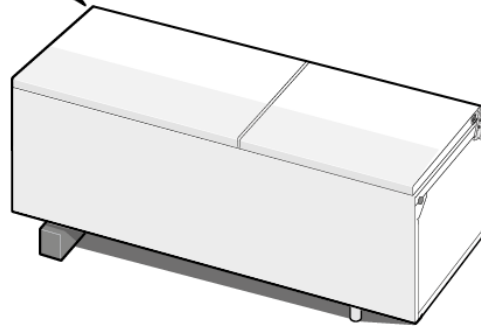
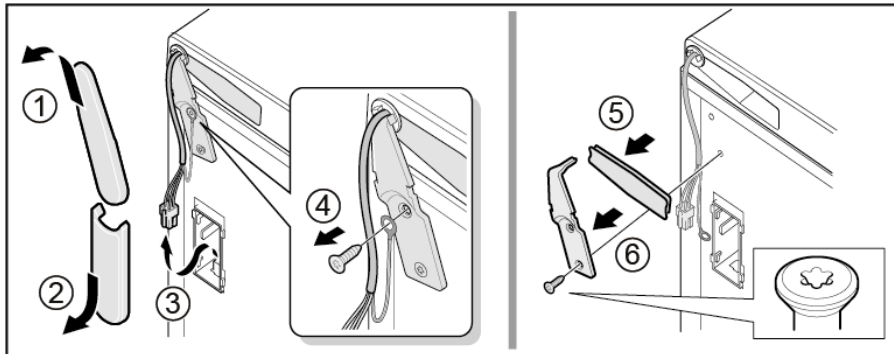

 Det øverste hængsel er fjernet.

4.4.2 Montering af øverste dørhængsel

- ▶ Montér i omvendt rækkefølge.

4.5 Udskiftning af midterste dørhængsel

Nødvendig værktøj:

🌀 Torx-bit TX20 6,3 mm (1/4") [00340865]

	⚠ ADVARSEL
	<p>Tunge, store apparater! Ryg- og muskelskader</p> <ul style="list-style-type: none"> ▶ Arbejde til fjernelse af apparatets dør bør kun udføres af uddannede specialister. ▶ Der skal være to personer om at flytte apparatet. ▶ Brug kun egnet værktøj og udstyr.

	⚠ PAS PÅ!
	<p>Skarpe kanter! Snitlæsioner</p> <ul style="list-style-type: none"> ▶ Brug beskyttelseshandsker.

	⚠ ADVARSEL
	<p>Apparater på skrå kan glide! Knoglebrud/klemskader</p> <ul style="list-style-type: none"> ▶ Sørg for at sikre apparater mod at glide.

	⚠ PAS PÅ!
	<p>Fare for nedfaldende dele pga. løsnede skruer! Personskade pga. nedfaldende dele.</p> <ul style="list-style-type: none"> ▶ Sørg for at sikre komponenten mod at falde ned.

	BEMÆRK!
	<p>Fare for nedfaldende dele pga. løsnede skruer! Beskadigelse af andre apparatdele eller kundens hjem, f.eks. gulvet.</p> <ul style="list-style-type: none"> ▶ Sørg for at sikre komponenten mod at falde ned.

Preindstilling:

- ✔ Apparatet er afbrudt fra strømforsyningen.
- ✔ Indvendigt tilbehør i apparatet er fjernet.
- ✔ Det øverste dørhængsel er fjernet.

4.5.1 Fjernelse af midterste dørhængsel

- ▶ 1. Fjern køleafdelingens dør (1).
- ▶ 2. Skru de to skruer ud (2).
- ▶ 3. Fjern det midterste hængsel (3).

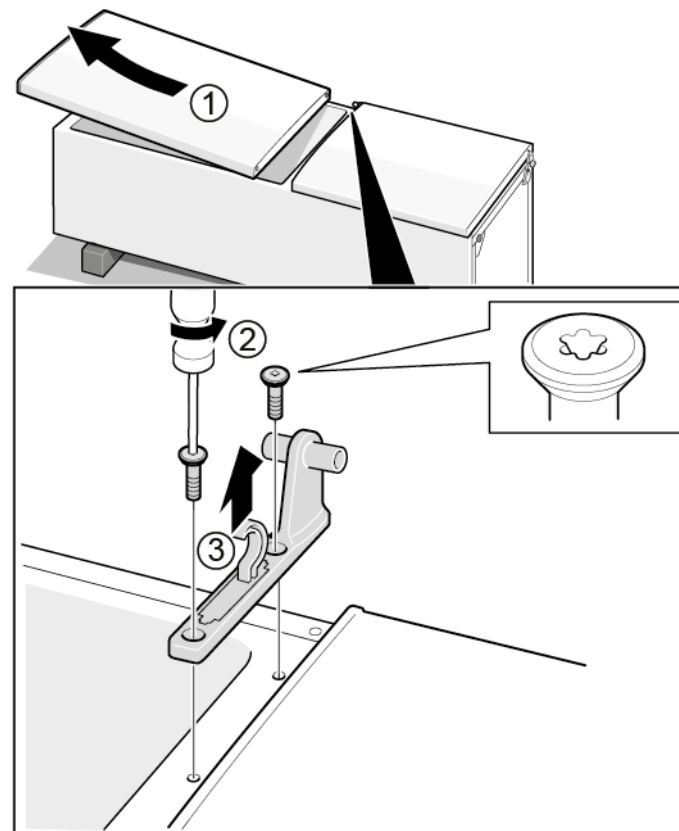

➡ Det midterste hængsel er fjernet.

4.5.2 Montering af midterste dørhængsel

- ▶ Montér i omvendt rækkefølge.

4.6 Udskiftning af nederste dørhængsel

Nødvendig værktøj:

Torx-bit TX20 6,3 mm (1/4") [00340865]

	ADVARSEL
Tunge, store apparater!	
Ryg- og muskelskader	
<ul style="list-style-type: none"> ▶ Arbejde til fjernelse af apparatets dør bør kun udføres af uddannede specialister. ▶ Der skal være to personer om at flytte apparatet. ▶ Brug kun egnet værktøj og udstyr. 	

	PAS PÅ!
Skarpe kanter!	
Snitlæsioner	
<ul style="list-style-type: none"> ▶ Brug beskyttelseshandsker. 	

	ADVARSEL
Apparater på skrå kan glide!	
Knoglebrud/klemskader	
<ul style="list-style-type: none"> ▶ Sørg for at sikre apparater mod at glide. 	

	PAS PÅ!
Fare for nedfaldende dele pga. løsnede skruer!	
Personskade pga. nedfaldende dele.	
<ul style="list-style-type: none"> ▶ Sørg for at sikre komponenten mod at falde ned. 	

	BEMÆRK!
Fare for nedfaldende dele pga. løsnede skruer!	
Beskadigelse af andre apparatdele eller kundens hjem, f.eks. gulvet.	
<ul style="list-style-type: none"> ▶ Sørg for at sikre komponenten mod at falde ned. 	

Preindstilling:

- ✔ Apparatet er afbrudt fra strømforsyningen.
- ✔ Indvendigt tilbehør i apparatet er fjernet.
- ✔ Det øverste hængsel er fjernet.
- ✔ Det midterste hængsel er fjernet.

4.6.1 Fjernelse af nederste dørhængsel

- ▶ 1. Fjern fryseafdelingens dør (1).
- ▶ 2. Skru skruen ud (2).
- ▶ 3. Drej det nederste hængsel ud (3).
- ▶ 4. Fjern det nederste hængsel (4).

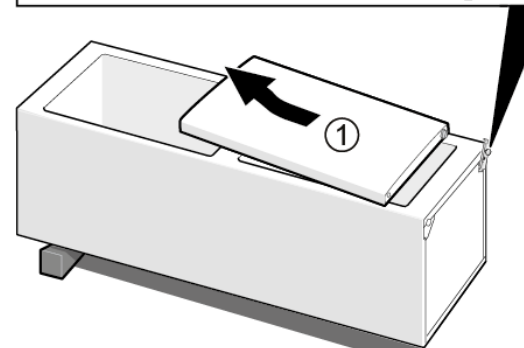
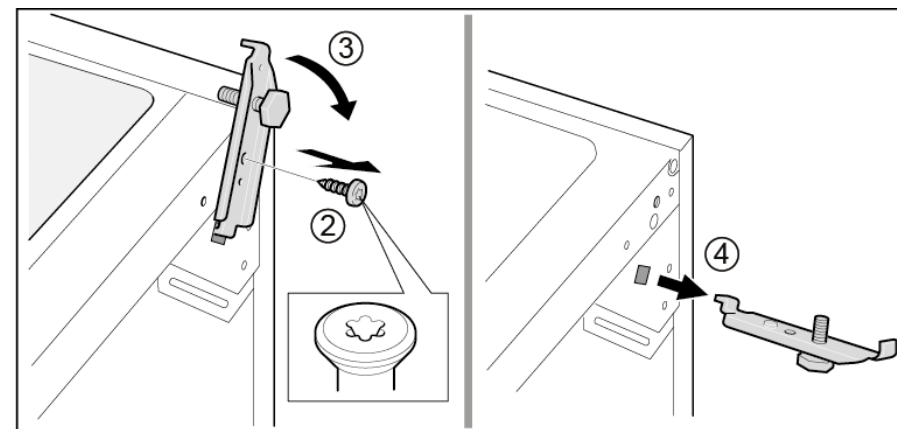

➡ Det nederste dørhængsel er fjernet.

4.6.2 Montering af nederste dørhængsel

- ▶ Montér i omvendt rækkefølge.

4.7 Udskiftning af hylde

Preindstilling:

- ✔ Døren er åben.

4.7.1 Fjernelse af hylde

- ▶ Træk hylde ud.

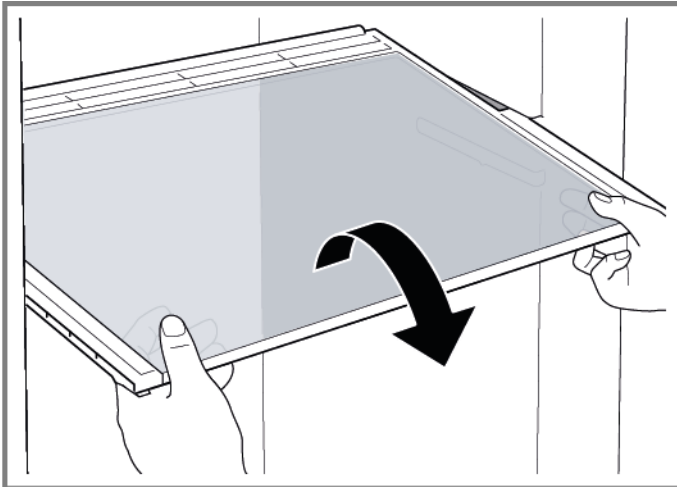

- ➡ Hylde er fjernet.

4.7.2 Montering af hylde

- ▶ Montér i omvendt rækkefølge.

4.8 Udskiftning af flaskehylde

Preindstilling:

- ✔ Døren er åben.

4.8.1 Fjernelse af flaskehylde

- ▶ Træk flaskehylde ud.

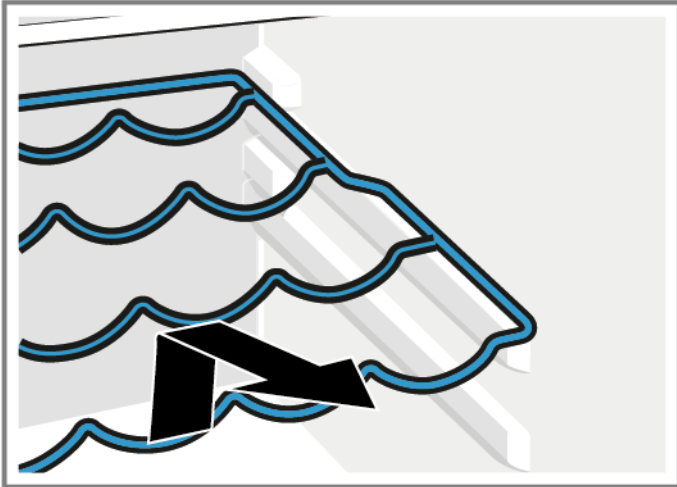

- ➡ Flaskehylde er fjernet.

4.8.2 Montering af flaskehylde

- ▶ Montér i omvendt rækkefølge.

4.9 Udskiftning af dørhylde

Preindstilling:

- ✔ Døren er åben.

4.9.1 Fjernelse af dørhylde

- ▶ Løft dørhylden opad.

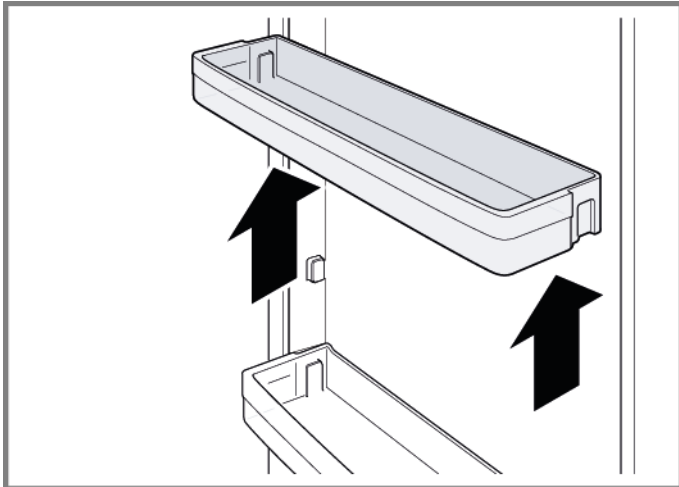

➡ Dørhylden er fjernet.

4.9.2 Montering af dørhylde

- ▶ Montér i omvendt rækkefølge.

4.10 Udskiftning af justerbar dørhylde

Preindstilling:

- ✔ Døren er åben.

4.10.1 Fjernelse af justerbar dørhylde

- ▶ Bevæg den højdejusterbare dørhylde opad, indtil dørhylden er frigjort fra holderen.

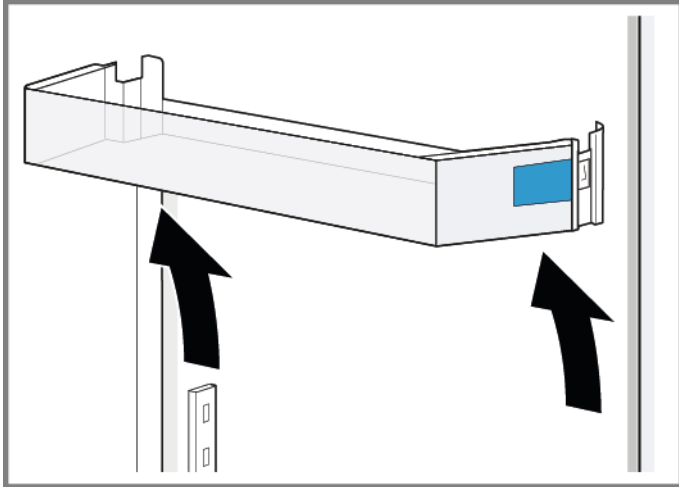

- ➡ Den justerbare dørhylde er fjernet.

4.10.2 Montering af justerbar dørhylde

- ▶ Montér i omvendt rækkefølge.

4.11 Udskiftning af frostvarebeholder

Preindstilling:

- ✔ Døren er åben.

4.11.1 Fjernelse af frostvarebeholder

- ▶ 1. Træk frostvarebeholderen hele vejen ud (1).
- ▶ 2. Fjern frostvarebeholderen (2).

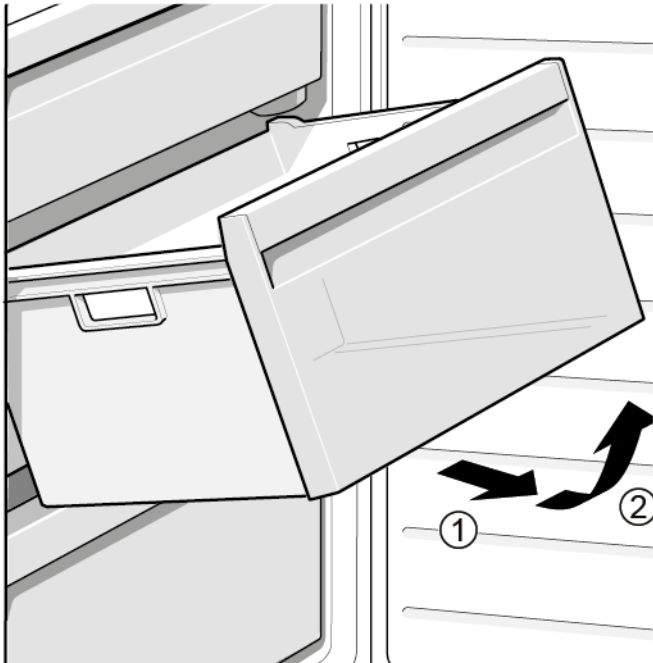

- ➡ Frostvarebeholderen er fjernet.

4.11.2 Montering af frostvarebeholder

- ▶ Montér i omvendt rækkefølge.

4.12 Udskiftning af beholder

Preindstilling:

- ✔ Døren er åben.

4.12.1 Fjernelse af beholder

- ▶ 1. Bevæg den nederste køleskabsbeholder ud (1).
- ▶ 2. Bevæg den øverste køleskabsbeholder ud (2).

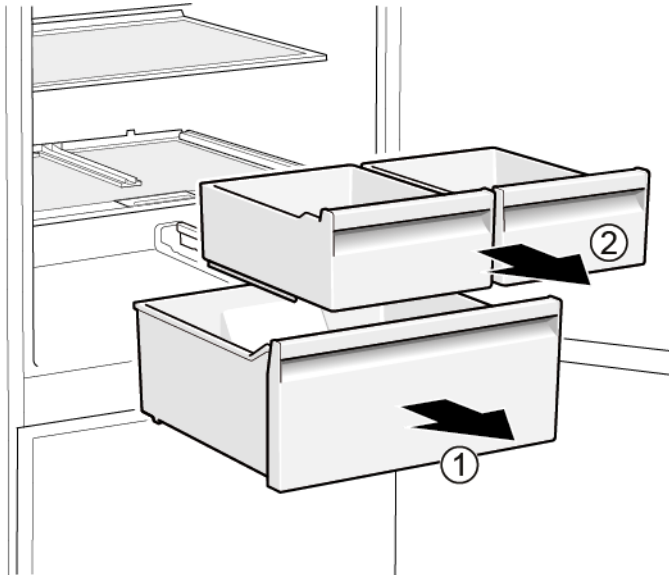

- ➡ Beholderne er fjernet.

4.12.2 Montering af beholder

- ▶ Montér i omvendt rækkefølge.

4.13 Udskiftning af udtrækkelig beholder

Preindstilling:

- ✔ Døren er åben.

4.13.1 Fjernelse af udtrækkelig beholder

- ▶ 1. Træk den udtrækkelige beholder hele vejen ud (1).
- ▶ 2. Fjern den udtrækkelige beholder (2).

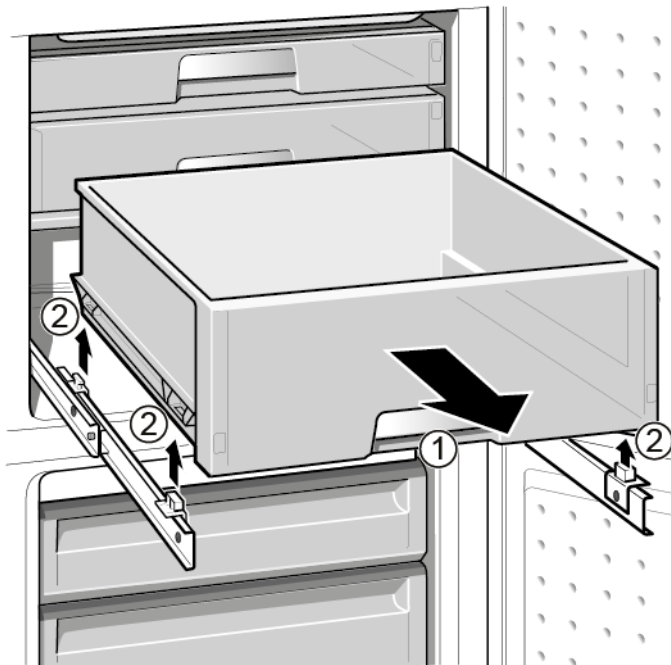

- ➡ Den udtrækkelige beholder er fjernet.

4.13.2 Montering af udtrækkelig beholder

- ▶ Montér i omvendt rækkefølge.

4.14 Udskiftning af LED-spotlampe

Nødvendig værktøj:

🔧 Specialværktøj [00342180]

i Dit apparat er udstyret med en vedligeholdelsesfri LED-lampe. Denne lampe må kun repareres af kundeservice eller autoriserede teknikere!

⚠️ FARE
Fare for elektrisk stød pga. spændingsførende dele!
Livsfare pga. elektrisk stød i tilfælde af ukorrekt reparation

- ▶ Elektriske dele skal repareres af kvalificerede elektrikere.
- ▶ Få efter reparationen udført en sikkerhedstest i henhold til VDE 0701 eller landespecifikke forskrifter.

⚠️ FARE
Fare for elektrisk stød pga. spændingsførende dele!
Død ved elektrisk stød

- ▶ Afbryd apparater fra strømforsyningen i mindst 60 sekunder, før reparationer påbegyndes.

⚠️ PAS PÅ!
Skarpe kanter!
Snitlæsioner

- ▶ Brug beskyttelseshandsker.

Preindstilling:

- ✔️ Apparatet er afbrudt fra strømforsyningen.
- ✔️ Døren er åben.

4.14.1 Fjernelse af LED-spotlampe

1. Brug specialværktøj til at trække LED-spotlampen ud (1).

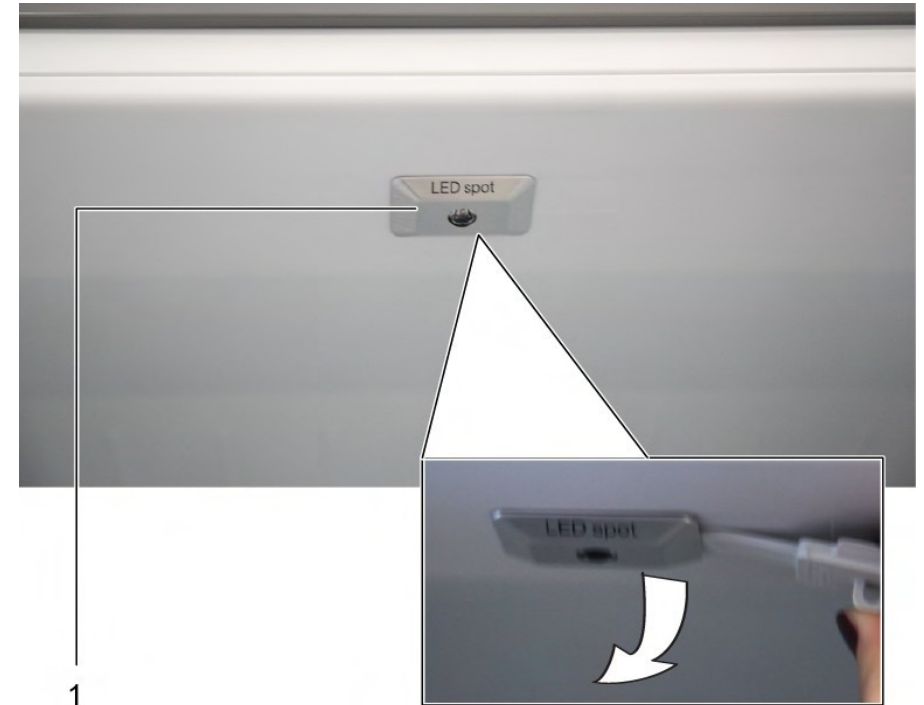

2. Afbryd LED-spotlampens elektriske tilslutninger.
- ➡️ LED-spotlampen er fjernet.

4.14.2 Montering af LED-spotlampe

- ▶ Montér i omvendt rækkefølge.

4.15 Udskiftning af LED-lampe foroven

Nødvendig værktøj:

- 🔧 Kærviskruetrækker Blad 2,4 mm x 0,4 mm x 60 mm i sættet [00341820]

i Dit apparat er udstyret med en vedligeholdelsesfri LED-lampe. Denne lampe må kun repareres af kundeservice eller autoriserede tekniker!

⚠️ FARE
Fare for elektrisk stød pga. spændingsførende dele!
Livsfare pga. elektrisk stød i tilfælde af ukorrekt reparation

- ▶ Elektriske dele skal repareres af kvalificerede elektrikere.
- ▶ Få efter reparationen udført en sikkerhedstest i henhold til VDE 0701 eller landespecifikke forskrifter.

⚠️ FARE
Fare for elektrisk stød pga. spændingsførende dele!
Død ved elektrisk stød

- ▶ Afbryd apparater fra strømforsyningen i mindst 60 sekunder, før reparationer påbegyndes.

⚠️ PAS PÅ!
Skarpe kanter!
Snitlæsioner

- ▶ Brug beskyttelseshandsker.

Preindstilling:

- ✔️ Apparatet er afbrudt fra strømforsyningen.
- ✔️ Døren er åben.
- ✔️ Indvendigt tilbehør foroven er fjernet.

4.15.1 Fjernelse af LED-lampe

1. Bevæg LED-lampen mod venstre.



- ➡️ LED-lampens elektriske tilslutning er afbrudt.

2. Frigør LED-lampens kroge.

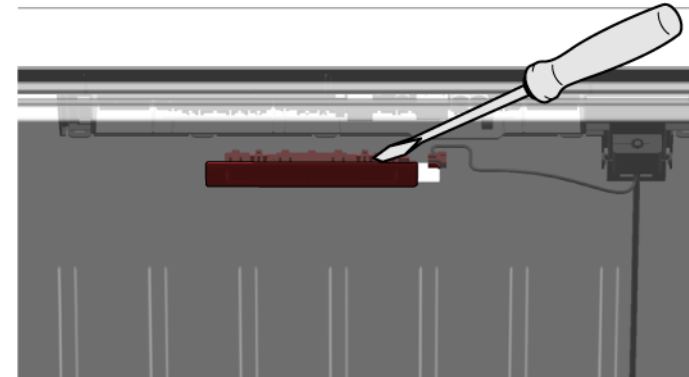

Reparation

3. Fjern LED-lampen ved at bevæge den fremad.

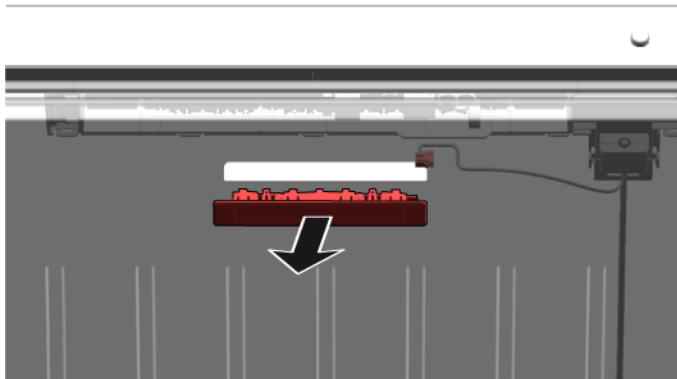

- ➡ LED-lampen er fjernet.

4.15.2 Montering af LED-lampe foroven

- ▶ Montér i omvendt rækkefølge.

4.16 Udskiftning af LED-sidebjælkelampe

Nødvendig værktøj:

🌀 Sugekop Ø50 mm [00342224]



Dit apparat er udstyret med en vedligeholdelsesfri LED-lampe. Denne lampe må kun repareres af kundeservice eller autoriserede teknikere!



FARE

Fare for elektrisk stød pga. spændingsførende dele!

Livsfare pga. elektrisk stød i tilfælde af ukorrekt reparation

- ▶ Elektriske dele skal repareres af kvalificerede elektrikere.
- ▶ Få efter reparationen udført en sikkerhedstest i henhold til VDE 0701 eller landespecifikke forskrifter.



FARE

Fare for elektrisk stød pga. spændingsførende dele!

Død ved elektrisk stød

- ▶ Afbryd apparater fra strømforsyningen i mindst 60 sekunder, før reparationer påbegyndes.



PAS PÅ!

Skarpe kanter!

Snitlæsioner

- ▶ Brug beskyttelseshandsker.

Preindstilling:

- ✓ Apparatet er afbrudt fra strømforsyningen.
- ✓ Døren er åben.
- ✓ Hyldeerne i køleafdelingen er fjernet.

4.16.1 Fjernelse LED-sidebjælkelampe

1. Sæt sugekoppen fast på den øverste tredjedel af LED-sidebjælkelampen.



Reparation

2. Træk sugekoppen fremad med LED-sidebjælkelampen i en drejende bevægelse.

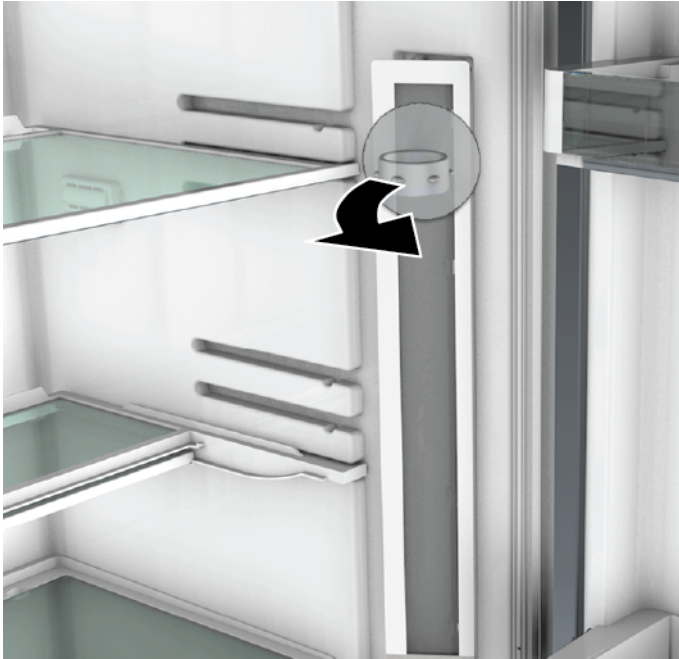

3. Afbryd LED-sidebjælkelampens elektriske tilslutning.
 LED-sidebjælkelampen er fjernet.

4.16.2 Montering af LED-sidebjælkelampe

1. Forbind LED-sidebjælkelampens elektriske tilslutning.
 2. Fastgør LED-sidebjælkelampen i dens placering på afdelingens væg (krogene klikker).
-  LED-sidebjælkelampen er monteret.

4.17 Udskiftning af LED-spotlampe

Nødvendig værktøj:

- Specialværktøj [00342180]
- Kærviskruetrækker Blad 2,4 mm x 0,4 mm x 60 mm i sættet [00341820]

 Dit apparat er udstyret med en vedligeholdelsesfri LED-lampe. Denne lampe må kun repareres af kundeservice eller autoriserede teknikere!

 **FARE**
Fare for elektrisk stød pga. spændingsførende dele!
Livsfare pga. elektrisk stød i tilfælde af ukorrekt reparation

- ▶ Elektriske dele skal repareres af kvalificerede elektrikere.
- ▶ Få efter reparationen udført en sikkerhedstest i henhold til VDE 0701 eller landespecifikke forskrifter.

 **FARE**
Fare for elektrisk stød pga. spændingsførende dele!
Død ved elektrisk stød

- ▶ Afbryd apparater fra strømforsyningen i mindst 60 sekunder, før reparationer påbegyndes.

 **PAS PÅ!**
Skarpe kanter!
Snitlæsioner

- ▶ Brug beskyttelseshandsker.

Preindstilling:

- ✓ Apparatet er afbrudt fra strømforsyningen.
- ✓ Døren er åben.
- ✓ Hyldeerne i køleafdelingen er fjernet.

4.17.1 Fjernelse af LED-spotlampe

1. Frigør LED-spotlampens afdækning.

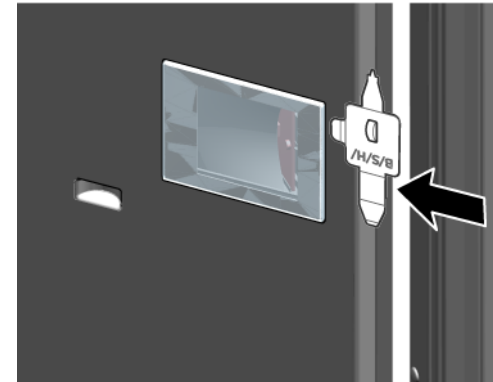

2. Træk LED-spotlampens afdækning indad, og skub den samtidigt fremad.

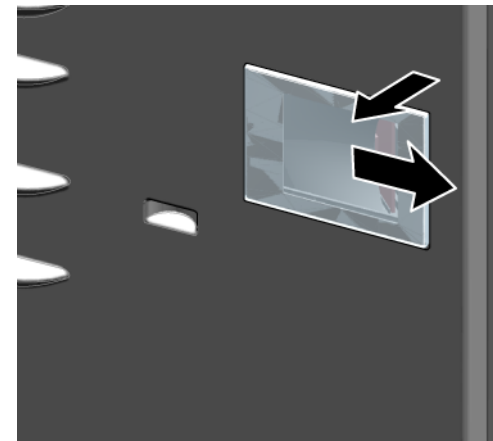

3. Frigør LED-spotlampemodulet.

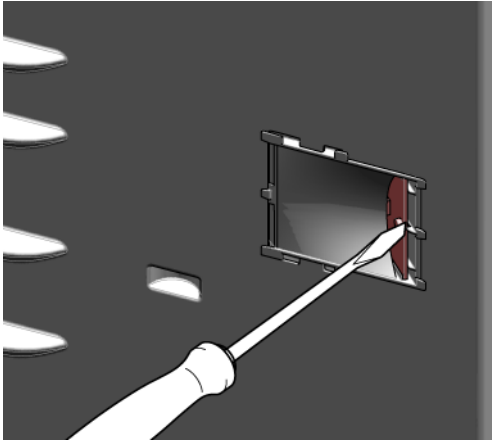

4. Afbryd LED-spotlampens elektriske tilslutning.

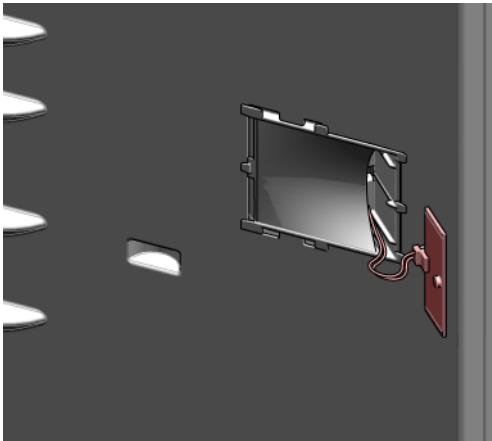

 LED-spotlampen er fjernet.

4.17.2 Montering af LED-spotlampe

▶ Montér i omvendt rækkefølge.

Reparatie informatie - Koelvriescombinatie

 Over dit document	119
1.1 Belangrijke informatie	119
1.1.1 Doel	119
1.2 Verklaring van symbolen.....	119
1.2.1 Gevarenniveaus.....	119
1.2.2 Gevarensymbolen.....	119
1.2.3 Structuur van de waarschuwingen.....	120
1.2.4 Algemene symbolen.....	120
 Veiligheid	121
2.1 Algemene veiligheidsinstructies.....	121
2.1.1 Alle huishoudelijke apparaten	121
 Gereedschappen en hulpmiddelen	122
 Reparatie	123
4.1 Deurafdichting vervangen	123
4.1.1 Deurafdichting verwijderen	123
4.1.2 Deurafdichting monteren	123
4.2 Deurgreep vervangen	126
4.2.1 Deurgreep verwijderen	126
4.2.2 Deurgreep monteren	126
4.3 Bovenste deurscharnier vervangen.....	127
4.3.1 Bovenste deurscharnier verwijderen.....	127
4.3.2 Bovenste deurscharnier monteren.....	128
4.4 Bovenste deurscharnier vervangen (deur met display).....	129
4.4.1 Bovenste deurscharnier verwijderen.....	129
4.4.2 Bovenste deurscharnier monteren.....	130
4.5 Middelste deurscharnier vervangen	131
4.5.1 Middelste deurscharnier verwijderen	131
4.5.2 Middelste deurscharnier monteren	131
4.6 Onderste deurscharnier vervangen.....	132
4.6.1 Onderste deurscharnier verwijderen.....	132
4.6.2 Onderste deurscharnier monteren.....	132
4.7 Plateau vervangen.....	133
4.7.1 Plateau verwijderen.....	133
4.7.2 Plateau monteren.....	133

4.8 Flessenrek vervangen	134
4.8.1 Flessenrek verwijderen	134
4.8.2 Flessenrek monteren	134
4.9 Deurrek vervangen	135
4.9.1 Deurrek verwijderen.....	135
4.9.2 Deurrek monteren	135
4.10 Verstelbaar deurrek vervangen	136
4.10.1 Verstelbaar deurrek verwijderen	136
4.10.2 Verstelbaar deurrek monteren	136
4.11 Vrieslade vervangen	137
4.11.1 Vrieslade verwijderen	137
4.11.2 Vrieslade installeren	137
4.12 Lade vervangen	138
4.12.1 Lade verwijderen	138
4.12.2 Lade installeren.....	138
4.13 Uittrekbare lade vervangen.....	139
4.13.1 Uittrekbare lade verwijderen.....	139
4.13.2 Uittrekbare lade monteren.....	139
4.14 LED-spot vervangen	140
4.14.1 LED-verlichting verwijderen.....	140
4.14.2 LED-verlichting installeren.....	140
4.15 LED-bovenlicht vervangen.....	141
4.15.1 LED-verlichting verwijderen.....	141
4.15.2 LED-bovenlicht installeren.....	142
4.16 LED-zijlichtbalk vervangen.....	143
4.16.1 LED-zijlichtbalk verwijderen.....	143
4.16.2 LED-zijlichtbalk installeren	144
4.17 LED-verlichting vervangen.....	145
4.17.1 LED-verlichting verwijderen.....	145
4.17.2 LED-verlichting installeren.....	146

i Over dit document

1.1 Belangrijke informatie

1.1.1 Doel

Met deze reparatieaanwijzingen wordt de klant geholpen zelf apparaten te repareren conform de toepasselijke verordening inzake ecologisch ontwerp (met ingang van 03/2021).





Ze bevatten informatie over hoe gedefinieerde reserveonderdelen kunnen worden vervangen met inbegrip van waarschuwingen en gevaren.

Neem bij vragen contact op met onze klantenservice. We stellen ons alleen aansprakelijk voor schade als de reparatieaanwijzingen correct zijn opgevolgd.

1.2 Verklaring van symbolen

1.2.1 Gevarenniveaus

De waarschuwningsniveaus worden aangegeven met een symbool en een signaalwoord. Het signaalwoord geeft de ernst van het gevaar aan.





Waarschuwningsniveau	Betekenis
	Als de waarschuwing niet in acht wordt genomen, leidt dat tot ernstig of dodelijk letsel.
	Als de waarschuwing niet in acht wordt genomen, kan dat tot ernstig of dodelijk letsel leiden.
	Als de waarschuwing niet in acht wordt genomen, kan dat tot licht letsel leiden.
	Als de waarschuwing niet in acht wordt genomen, kan dat tot materiële schade leiden.

Tabel 1: Gevarenniveaus

1.2.2 Gevarensymbolen

Gevarensymbolen zijn symbolische afbeeldingen die een indicatie geven van het soort gevaar.

De volgende gevarensymbolen worden in dit document gebruikt:

Gevarensymbool	Betekenis
	Algemene waarschuwing
	Gevaar voor elektrische spanning
	Ontploffingsgevaar
	Snijgevaar

i Over dit document

Gevarensymbool	Betekenis
	Beknellingsgevaar
	Gevaar voor hete oppervlakken
	Gevaar voor sterke magnetische velden
	Gevaar voor niet-ioniserende straling

Tabel 2: Gevarensymbolen

1.2.3 Structuur van de waarschuwingen

Waarschuwingen in dit document hebben een gestandaardiseerd uiterlijk en een gestandaardiseerde structuur.







	<div style="background-color: red; color: white; padding: 2px; text-align: center;">⚠ GEVAAR</div> <p>Soort gevaar en bron van het gevaar! Mogelijke gevolgen van het negeren van het gevaar / de waarschuwing.</p> <ul style="list-style-type: none"> ▶ Maatregelen en verboden om het gevaar te voorkomen.
--	---

In het volgende voorbeeld is een waarschuwing te zien waarmee voor een elektrische schok aan stroomvoerende onderdelen wordt gewaarschuwd. De maatregel om het gevaar te vermijden wordt vermeld.

	<div style="background-color: red; color: white; padding: 2px; text-align: center;">⚠ GEVAAR</div> <p>Gevaar voor een elektrische schok aan stroomvoerende onderdelen! Dood door elektrocutie</p> <ul style="list-style-type: none"> ▶ Haal apparaten minstens 60 seconden voor u met reparaties begint van de stroomvoorziening af.
--	---

1.2.4 Algemene symbolen

De volgende algemene symbolen worden in dit document gebruikt:

Alg. symbool	Betekenis
	Identificatie van een speciale tip (tekst en/of afbeelding)
	Identificatie van een eenvoudige tip (tekst)
	Identificatie van een link naar een video-instructie
	Identificatie van vereiste gereedschappen
	Identificatie van vereiste voorwaarden
	Identificatie van een voorwaarde (als ..., dan ...)
	Identificatie van een resultaat
[Start]	Identificatie van een toets of knop
[00123456]	Identificatie van een materiaalnummer
Status	Identificatie van weergegeven tekst / venster (in het display van het apparaat)

Tabel 3: Algemene symbolen

2.1 Algemene veiligheidsinstructies

2.1.1 Alle huishoudelijke apparaten

Gevaar voor een elektrische schok aan stroomvoerende onderdelen!

- Fouten bij reparaties aan elektrische componenten kunnen tot een elektrische schok leiden!
- Koppel het apparaat minstens 60 seconden los van het stroomnet voordat u met de werkzaamheden begint.
- Laat na de reparatie een veiligheidstest conform VDE 0701 of de landspecifieke regelgeving uitvoeren.

Gevaar voor letsel aan scherpe randen!

- Draag veiligheidshandschoenen.

Beknellingsgevaar tijdens reparatie, onderhoud, probleemoplossing en service vanwege zware en bewegende componenten

- Draag veiligheidsschoenen.
- Beveilig zware componenten tegen vallen.
- Steek geen lichaamsdelen in bewegende componenten.





Gevaar voor de veiligheid / werking van het apparaat!

- Gebruik uitsluitend originele reserveonderdelen.

Gevaar voor schade aan elektrostatisch gevoelige componenten (ESD's)!

- Raak de modules met inbegrip van de aansluitingen en geleiderbanen niet aan.

Gereedschappen en hulpmiddelen

Benaming	Details	Afbeeldingen
Beschermdoek [00342013]	60 cm x 50 cm	
Sleufschroeven- draaier	Kop 2,4 mm x 0,4 mm x 60 mm, in de set [00341820]	
Speciaal gereed- schap [00342180]		
Zuignap [00342224]	Ø50 mm	
Torxbit TX20 [00340865]	6,3 mm (1/4")	
Sleufschroeven- draaier	Kop 10 mm x 1,6 mm x 200 mm	

4.1 Deurafdichting vervangen

Voorwaarde:

- ✔ Deur is open.

4.1.1 Deurafdichting verwijderen

1. Haal deurafdichting los uit de sleuf in de rechter- en linkerhoek.

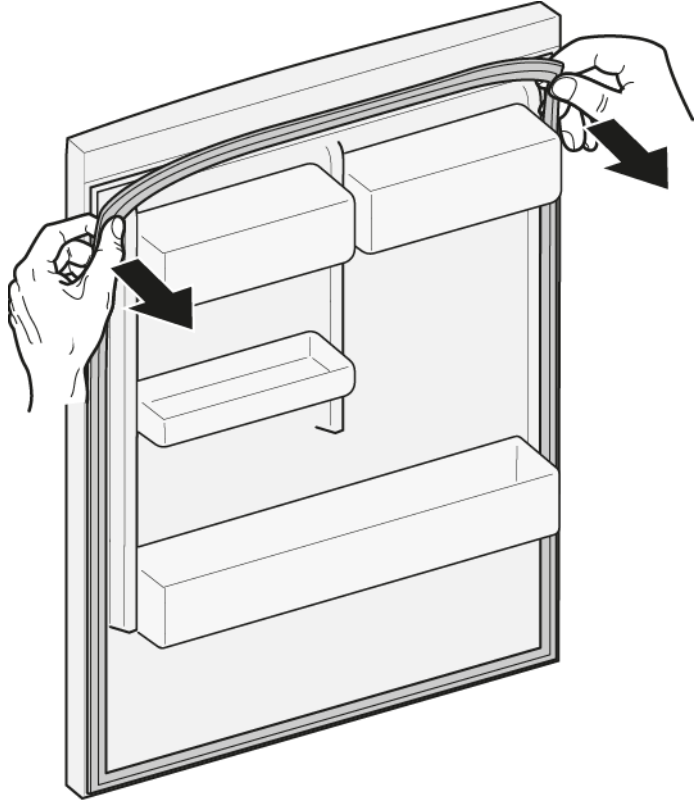



2. Trek deurafdichting uit gleuf.



- ➡ Deurafdichting wordt verwijderd.

4.1.2 Deurafdichting monteren

	De dikte van de nieuwe deurafdichting kan licht afwijken van de dikte van de oude deurafdichting. Dit doet geen afbreuk aan de sluiteigenschappen en de werking op de lange termijn.
	Als uw apparaat verstelbare scharnieren of scharnierbevestigingen heeft, kunt u de sluiteigenschappen later optimaliseren.
	De zijgaatjes in de deurafdichting zijn functioneel (vereist voor ventilatie). Dit zijn geen productiefouten.

Reparatie

1. Controleer de sleuf voor de afdichting op schade.

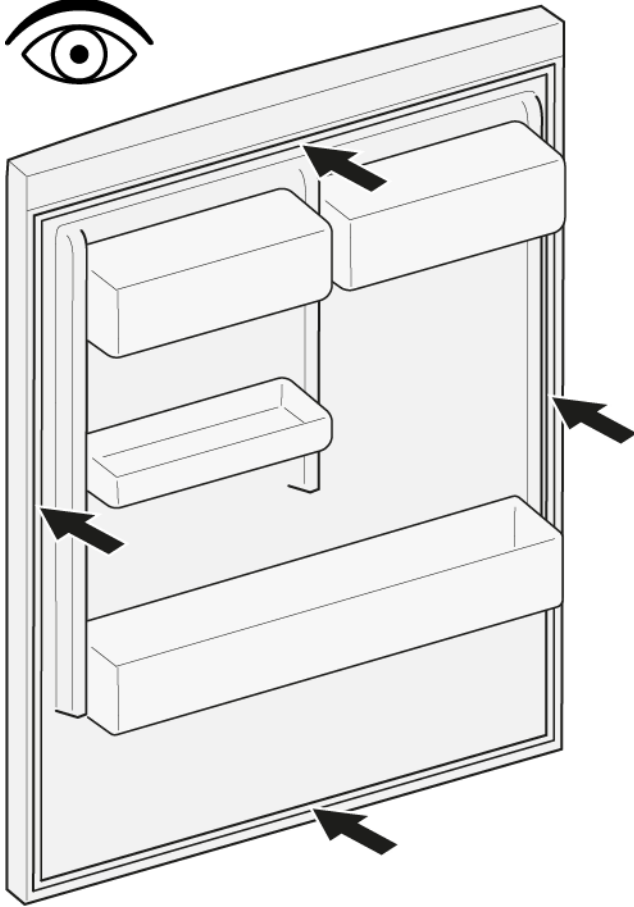

4. Duw de hoeken van de afdichting bovenaan en onderaan in de sleuf.

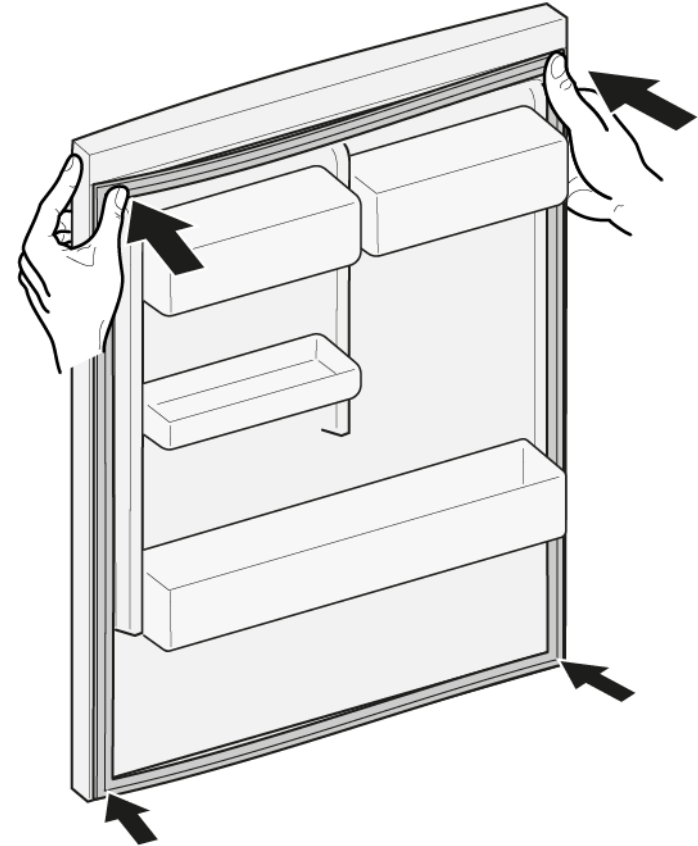

2.  Als de sleuf voor de afdichting is beschadigd:
 - Neem contact op met de klantenservice.

3.  Een lichte vervorming van de deurafdichting is normaal en doet geen afbreuk aan de werking. Geadviseerd wordt de deurafdichting recht te trekken voordat u deze in het apparaat steekt.

Verwarm de deurafdichting met een haardroger of met warm water en breng het handmatig terug in zijn vorm.

Reparatie



5. Druk de hele afdichting stap voor stap in de sleuf.





-  De deurafdichting wordt gemonteerd.

4.2 Deurgreep vervangen

Speciale hulpmiddelen:

-  Torxbit TX20 6,3 mm (1/4") [00340865]
-  Sleufschroevendraaier Kop 10 mm x 1,6 mm x 200 mm

Voorwaarde:

-  Apparaat is losgekoppeld is van de stroomvoorziening.
-  Deur is open.

4.2.1 Deurgreep verwijderen

- ▶ 1. Verwijder twee schroefkappen (1).
- ▶ 2. Draai de twee schroeven los (2).
- ▶ 3. Verwijder de deurgreep (3).

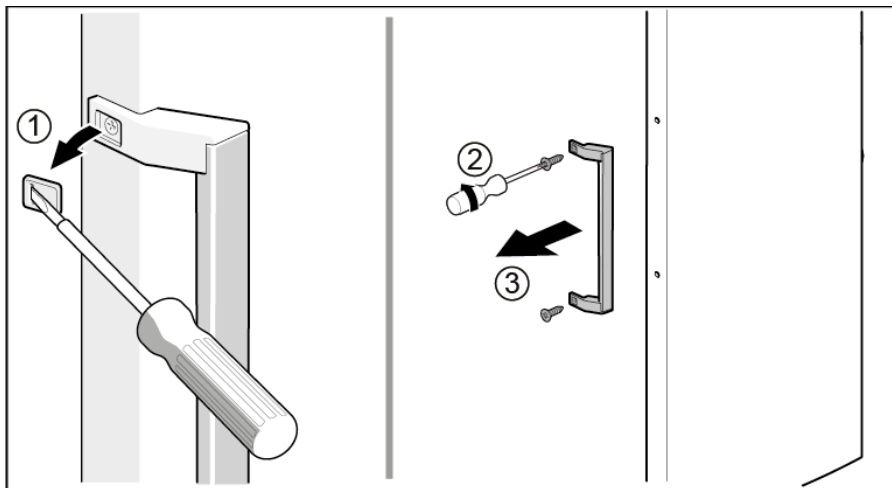

 Deurgreep wordt verwijderd.



Deurgreep voor de tweede deur kan op dezelfde manier worden verwijderd.

4.2.2 Deurgreep monteren

- ▶ Monteer in omgekeerde volgorde.





4.3 Bovenste deurscharnier vervangen

Speciale hulpmiddelen:

Torxbit TX20

6,3 mm (1/4")

[00340865]

	<p>WAARSCHUWING</p> <p>Zware, omvangrijke apparaten! Rug- en spierletsel</p> <ul style="list-style-type: none">▶ De werkzaamheid van het verwijderen van de apparaatdeur mag alleen worden uitgevoerd door speciaal opgeleid personeel.▶ Om het apparaat te verplaatsen zijn twee mensen nodig.▶ Gebruik alleen geschikte gereedschappen en apparatuur.
	<p>VOORZICHTIG</p> <p>Scherpe randen! Snijletsel</p> <ul style="list-style-type: none">▶ Draag veiligheidshandschoenen.
	<p>WAARSCHUWING</p> <p>Weggliden van schuin staande apparaten! Botbreuken / beknellingsletsel</p> <ul style="list-style-type: none">▶ Beveilig apparaten tegen wegglijden.
	<p>VOORZICHTIG</p> <p>Gevaar voor vallende onderdelen als gevolg van losgeraakte schroeven! Letsel als gevolg van vallende onderdelen.</p> <ul style="list-style-type: none">▶ Beveilig component tegen vallen.
	<p>LET OP!</p> <p>Gevaar voor vallende onderdelen als gevolg van losgeraakte schroeven! Schade aan andere onderdelen van het apparaat of bij de klant thuis bijvoorbeeld aan de vloer.</p> <ul style="list-style-type: none">▶ Beveilig component tegen vallen.

Voorwaarde:

- ✓ Apparaat is losgekoppeld van de stroomvoorziening.
- ✓ Het interieur van het apparaat is verwijderd.

4.3.1 Bovenste deurscharnier verwijderen

1. Leg het apparaat op zijn achterkant.

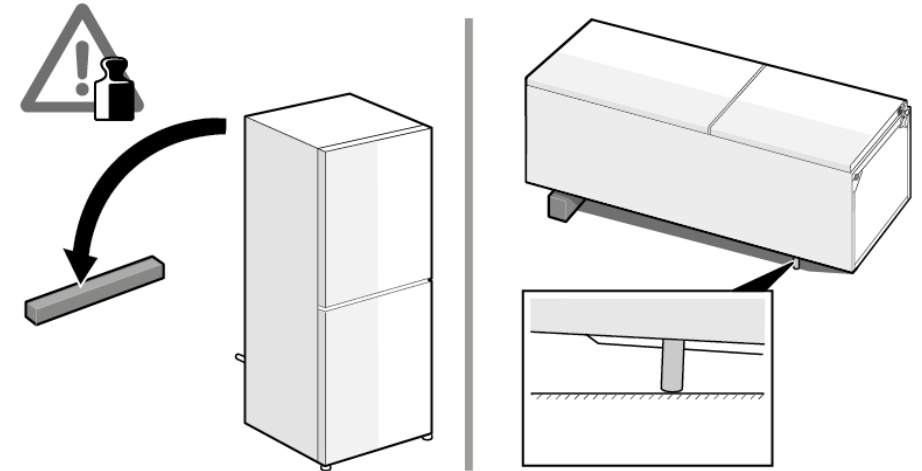

Reparatie

2. 1. Druk aan beide kanten op de bovenste scharnierafdekking (1).
2. Haal de bovenste scharnierafdekking eruit (2).
3. Draai de scharnierafdekking (3).
4. Verwijder de bovenste scharnierafdekking (4).
5. Draai de twee schroeven los (5).
6. Verwijder het bovenste scharnier (6).

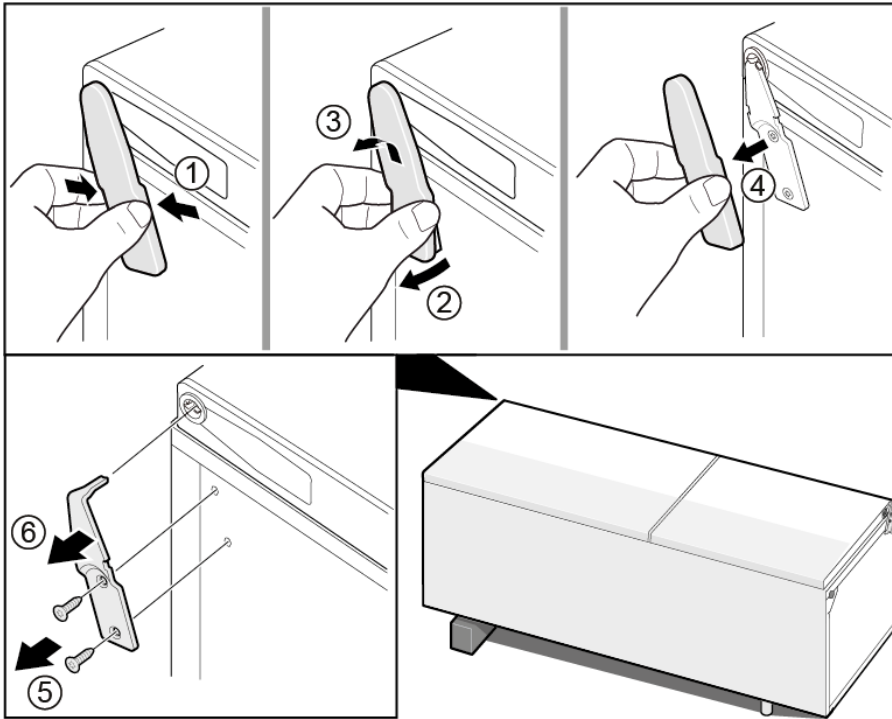

 Het bovenste scharnier wordt verwijderd.

4.3.2 Bovenste deurscharnier monteren

- ▶ Monteer in omgekeerde volgorde.

4.4 Bovenste deurscharnier vervangen (deur met display)

Speciale hulpmiddelen:

Torxbit TX20 6,3 mm (1/4") [00340865]

	WAARSCHUWING
	<p>Zware, omvangrijke apparaten! Rug- en spierletsel</p> <ul style="list-style-type: none"> ▶ De werkzaamheid van het verwijderen van de apparaatdeur mag alleen worden uitgevoerd door speciaal opgeleid personeel. ▶ Om het apparaat te verplaatsen zijn twee mensen nodig. ▶ Gebruik alleen geschikte gereedschappen en apparatuur.

	VOORZICHTIG
	<p>Scherpe randen! Snijletsel</p> <ul style="list-style-type: none"> ▶ Draag veiligheidshandschoenen.

	WAARSCHUWING
	<p>Weggliden van schuin staande apparaten! Botbreuken / beknellingsletsel</p> <ul style="list-style-type: none"> ▶ Beveilig apparaten tegen wegglijden.

	VOORZICHTIG
	<p>Gevaar voor vallende onderdelen als gevolg van losgeraakte schroeven! Letsel als gevolg van vallende onderdelen.</p> <ul style="list-style-type: none"> ▶ Beveilig component tegen vallen.

	LET OP!
	<p>Gevaar voor vallende onderdelen als gevolg van losgeraakte schroeven! Schade aan andere onderdelen van het apparaat of bij de klant thuis bijvoorbeeld aan de vloer.</p> <ul style="list-style-type: none"> ▶ Beveilig component tegen vallen.

	GEVAAR
	<p>Gevaar voor een elektrische schok aan stroomvoerende onderdelen! Levensgevaar door elektrische schokken in geval van een ondeskundige reparatie</p> <ul style="list-style-type: none"> ▶ Elektrische onderdelen moeten door gekwalificeerde elektriciens worden gerepareerd. ▶ Laat na de reparatie een veiligheidstest conform VDE 0701 of de landspecifieke regelgeving uitvoeren.

	GEVAAR
	<p>Gevaar voor een elektrische schok aan stroomvoerende onderdelen! Dood door elektrocutie</p> <ul style="list-style-type: none"> ▶ Haal apparaten minstens 60 seconden voor u met reparaties begint van de stroomvoorziening af.

Voorwaarde:

- ✓ Apparaat is losgekoppeld is van de stroomvoorziening.
- ✓ Het interieur van het apparaat is verwijderd.

4.4.1 Bovenste deurscharnier verwijderen

1. Leg het apparaat op zijn achterkant.

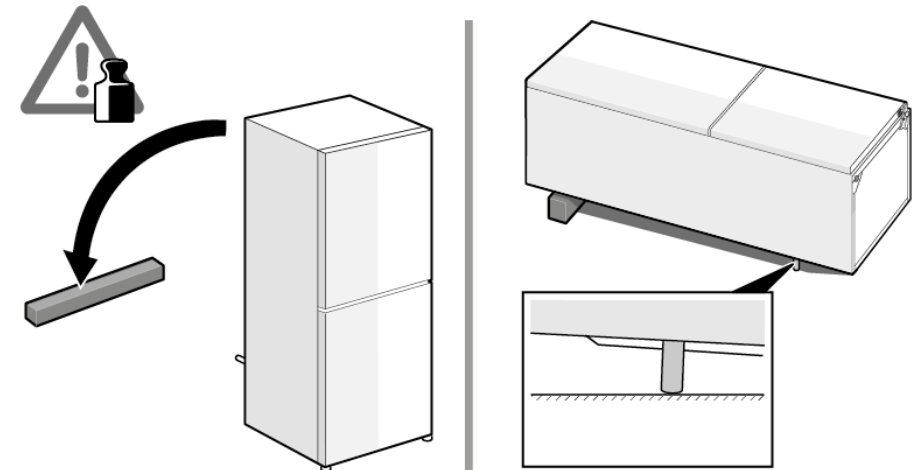

Reparatie

2. 1. Verwijder de bovenste scharnierafdekking (1).
2. Verwijder de afdekking van de aansluitdoos (2).
3. Haal de elektrische aansluiting los (3).
4. Draai de aardverbindingsschroef los (4).
5. Verwijder de kabelbeschermer (5).
6. Draai de schroef (6) los.

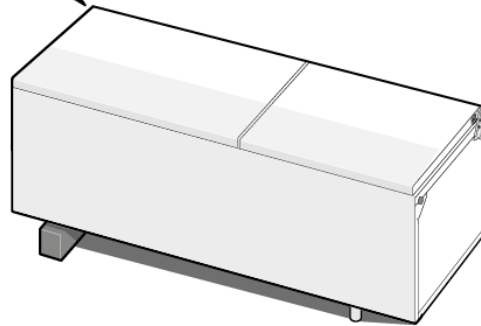
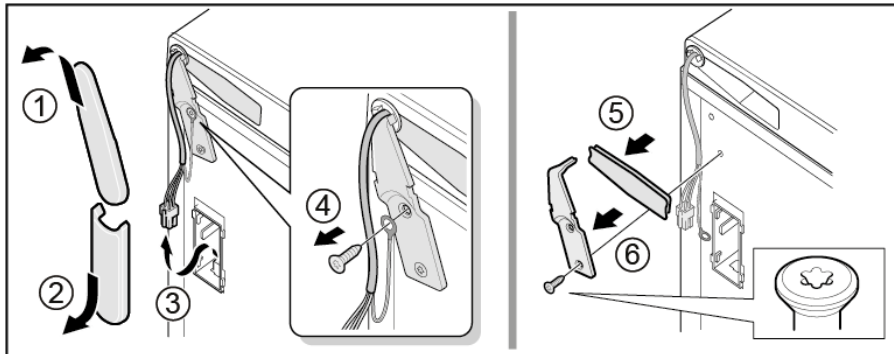

 Het bovenste scharnier wordt verwijderd.

4.4.2 Bovenste deurscharnier monteren

- ▶ Monteer in omgekeerde volgorde.

4.5 Middelste deurscharnier vervangen

Speciale hulpmiddelen:

Torxbit TX20 6,3 mm (1/4") [00340865]

	WAARSCHUWING
	<p>Zware, omvangrijke apparaten! Rug- en spierletsel</p> <ul style="list-style-type: none"> ▶ De werkzaamheid van het verwijderen van de apparaatdeur mag alleen worden uitgevoerd door speciaal opgeleid personeel. ▶ Om het apparaat te verplaatsen zijn twee mensen nodig. ▶ Gebruik alleen geschikte gereedschappen en apparatuur.

	VOORZICHTIG
	<p>Scherpe randen! Snijletsel</p> <ul style="list-style-type: none"> ▶ Draag veiligheidshandschoenen.

	WAARSCHUWING
	<p>Weggliden van schuin staande apparaten! Botbreuken / beknellingsletsel</p> <ul style="list-style-type: none"> ▶ Beveilig apparaten tegen wegglijden.

	VOORZICHTIG
	<p>Gevaar voor vallende onderdelen als gevolg van losgeraakte schroeven! Letsel als gevolg van vallende onderdelen.</p> <ul style="list-style-type: none"> ▶ Beveilig component tegen vallen.

	LET OP!
	<p>Gevaar voor vallende onderdelen als gevolg van losgeraakte schroeven! Schade aan andere onderdelen van het apparaat of bij de klant thuis bijvoorbeeld aan de vloer.</p> <ul style="list-style-type: none"> ▶ Beveilig component tegen vallen.

Voorwaarde:

- ✔ Apparaat is losgekoppeld is van de stroomvoorziening.
- ✔ Het interieur van het apparaat is verwijderd.

- ✔ Het bovenste deurscharnier wordt verwijderd.

4.5.1 Middelste deurscharnier verwijderen

- ▶ 1. Verwijder de deur van het koelvak (1).
- ▶ 2. Draai de twee schroeven los (2).
- ▶ 3. Verwijder het middelste scharnier (3).

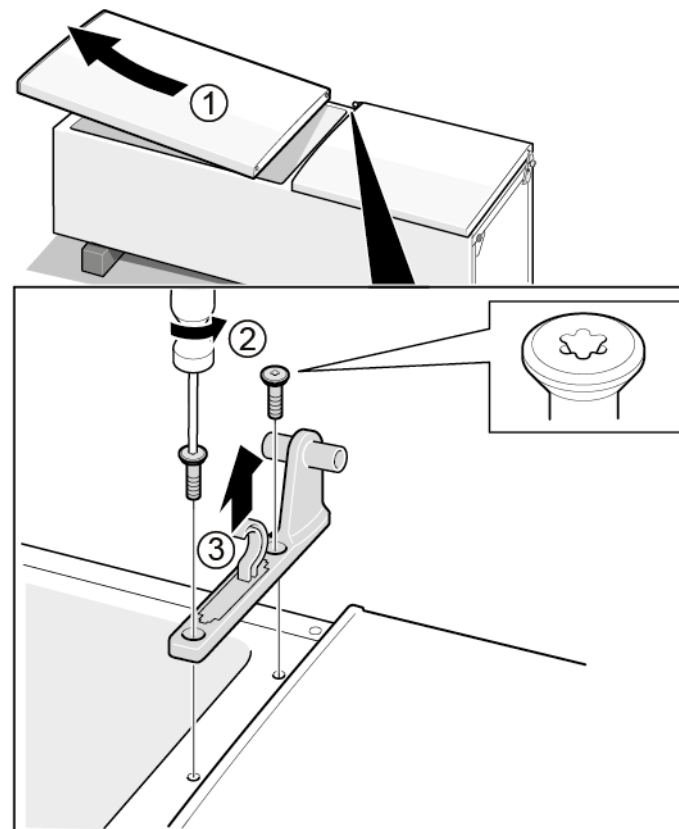

- ➡ Het middelste scharnier wordt verwijderd.

4.5.2 Middelste deurscharnier monteren

- ▶ Monteer in omgekeerde volgorde.

4.6 Onderste deurscharnier vervangen

Speciale hulpmiddelen:

Torxbit TX20

6,3 mm (1/4")

[00340865]

	<p>WAARSCHUWING</p> <p>Zware, omvangrijke apparaten! Rug- en spierletsel</p> <ul style="list-style-type: none"> ▶ De werkzaamheid van het verwijderen van de apparaatdeur mag alleen worden uitgevoerd door speciaal opgeleid personeel. ▶ Om het apparaat te verplaatsen zijn twee mensen nodig. ▶ Gebruik alleen geschikte gereedschappen en apparatuur.
	<p>VOORZICHTIG</p> <p>Scherpe randen! Snijletsel</p> <ul style="list-style-type: none"> ▶ Draag veiligheidshandschoenen.
	<p>WAARSCHUWING</p> <p>Weggliden van schuin staande apparaten! Botbreuken / beknellingsletsel</p> <ul style="list-style-type: none"> ▶ Beveilig apparaten tegen wegglijden.
	<p>VOORZICHTIG</p> <p>Gevaar voor vallende onderdelen als gevolg van losgeraakte schroeven! Letsel als gevolg van vallende onderdelen.</p> <ul style="list-style-type: none"> ▶ Beveilig component tegen vallen.
	<p>LET OP!</p> <p>Gevaar voor vallende onderdelen als gevolg van losgeraakte schroeven! Schade aan andere onderdelen van het apparaat of bij de klant thuis bijvoorbeeld aan de vloer.</p> <ul style="list-style-type: none"> ▶ Beveilig component tegen vallen.

Voorwaarde:

- ✔ Apparaat is losgekoppeld is van de stroomvoorziening.
- ✔ Het interieur van het apparaat is verwijderd.

- ✔ Het bovenste scharnier wordt verwijderd.
- ✔ Het middelste scharnier wordt verwijderd.

4.6.1 Onderste deurscharnier verwijderen

- ▶ 1. Verwijder de deur van het vriesvak (1).
- ▶ 2. Draai de schroef (2) los.
- ▶ 3. Draai het onderste scharnier eruit (3).
- ▶ 4. Verwijder het onderste scharnier (4).

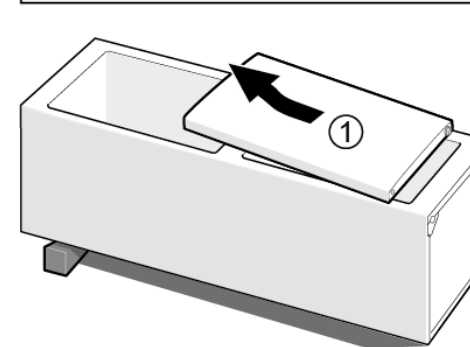
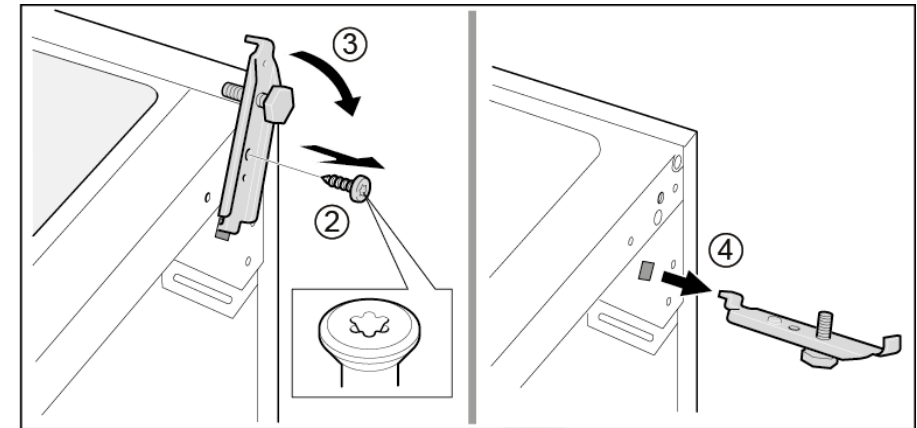

- ➡ Het onderste deurscharnier wordt verwijderd.

4.6.2 Onderste deurscharnier monteren

- ▶ Monteer in omgekeerde volgorde.

4.7 Plateau vervangen

Voorwaarde:

- ✔ Deur is open.

4.7.1 Plateau verwijderen

- ▶ Trek het plateau eruit.

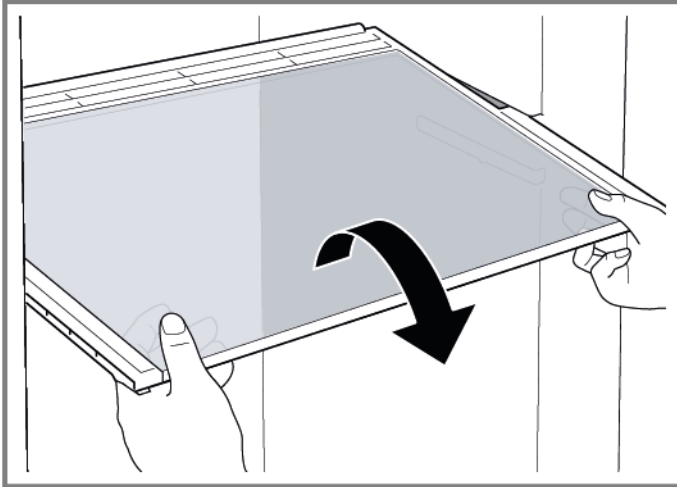

➡ Plateau wordt verwijderd.

4.7.2 Plateau monteren

- ▶ Monteer in omgekeerde volgorde.

4.8 Flessenrek vervangen

Voorwaarde:

- ✔ Deur is open.

4.8.1 Flessenrek verwijderen

- ▶ Trek het flessenrek eruit.

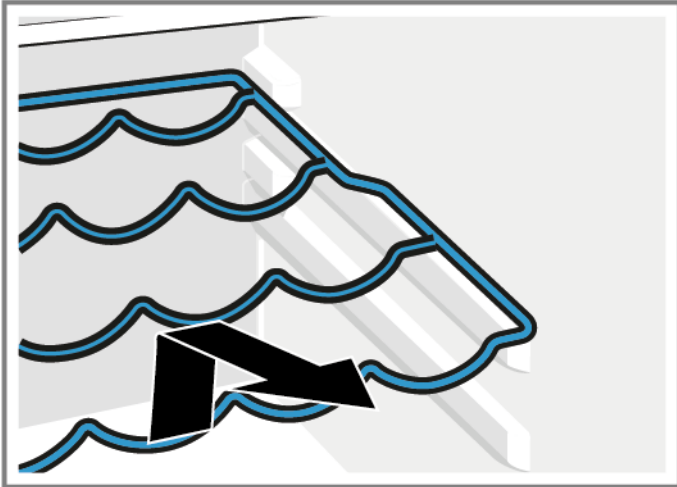

- ➡ Flessenrek wordt verwijderd.

4.8.2 Flessenrek monteren

- ▶ Monteer in omgekeerde volgorde.

4.9 Deurrek vervangen

Voorwaarde:

- ✔ Deur is open.

4.9.1 Deurrek verwijderen

- ▶ Licht het deurrek omhoog.

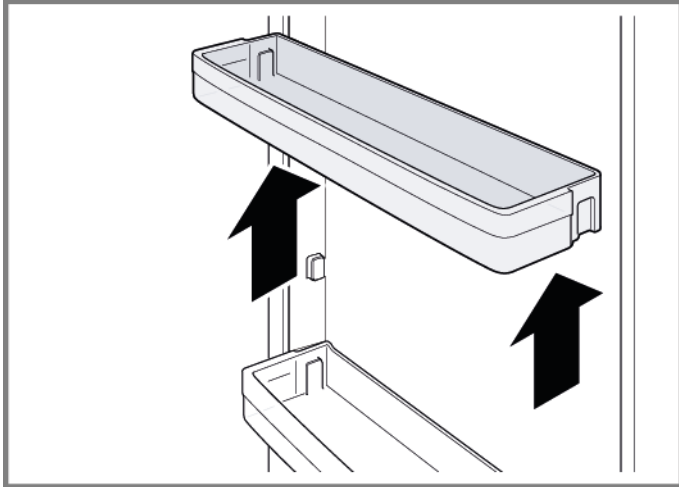

- ➡ Deurrek wordt verwijderd.

4.9.2 Deurrek monteren

- ▶ Monteer in omgekeerde volgorde.

4.10 Verstelbaar deurrek vervangen

Voorwaarde:

- ✔ Deur is open.

4.10.1 Verstelbaar deurrek verwijderen

- ▶ Beweeg het in hoogte verstelbare deurrek omhoog tot het deurrek loskomt uit de houder.

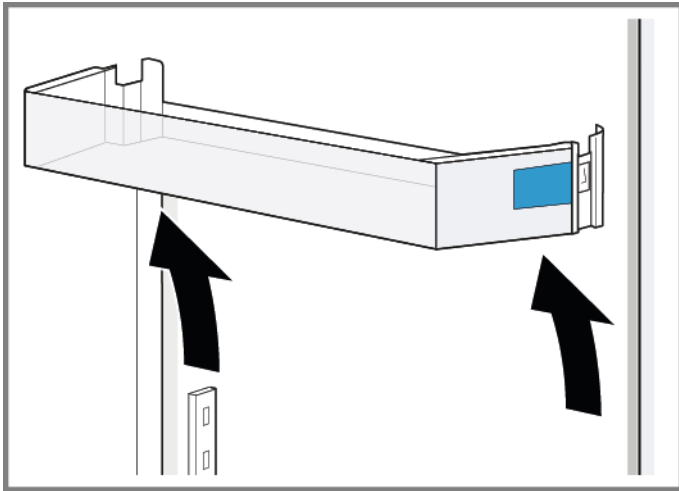

- ➡ Verstelbaar deurrek wordt verwijderd.

4.10.2 Verstelbaar deurrek monteren

- ▶ Monteer in omgekeerde volgorde.

4.11 Vrieslade vervangen

Voorwaarde:

- ✔ Deur is open.

4.11.1 Vrieslade verwijderen

- ▶ 1. Trek de vrieslade er helemaal uit (1).
- ▶ 2. Verwijder de vrieslade (2).

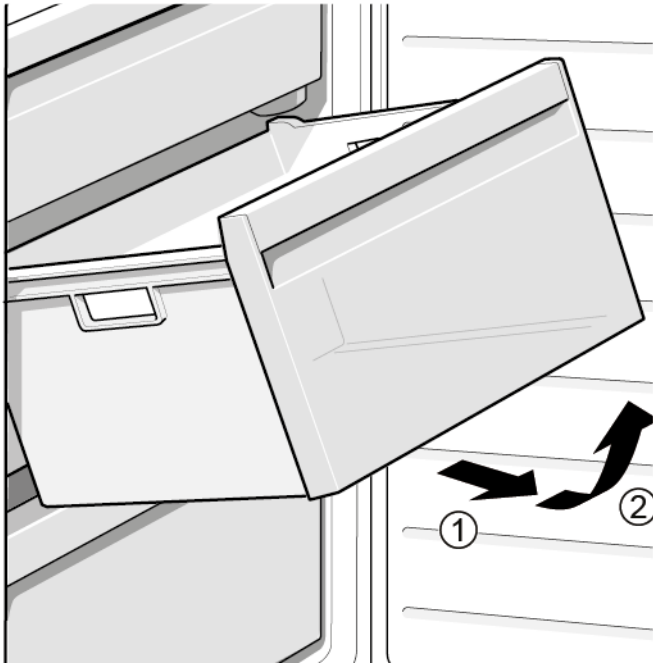

- ➡ Vrieslade wordt verwijderd.

4.11.2 Vrieslade installeren

- ▶ Monteer in omgekeerde volgorde.

4.12 Lade vervangen

Voorwaarde:

- ✔ Deur is open.

4.12.1 Lade verwijderen

- ▶ 1. Haal de onderste koellade eruit (1).
- ▶ 2. Haal de bovenste koellade eruit (2).

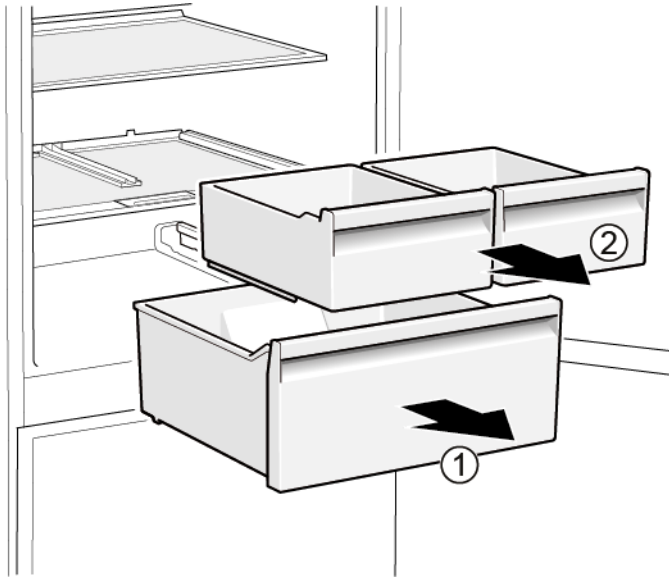

- ➡ De lades worden verwijderd.

4.12.2 Lade installeren

- ▶ Monteer in omgekeerde volgorde.

4.13 Uittrekbare lade vervangen

Voorwaarde:

- ✔ Deur is open.

4.13.1 Uittrekbare lade verwijderen

- ▶ 1. Trek de uittrekbare lade er helemaal uit (1).
- ▶ 2. Verwijder de uittrekbare lade (2).

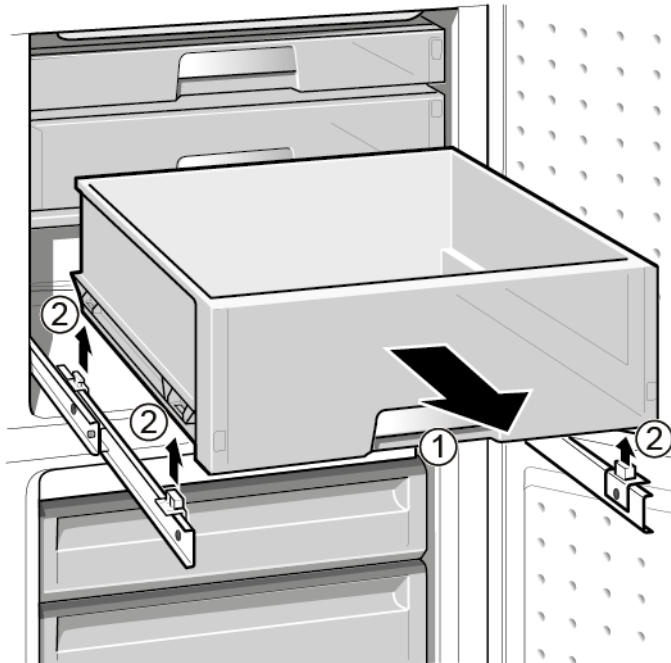

- ➡ Uittrekbare lade wordt verwijderd.

4.13.2 Uittrekbare lade monteren

- ▶ Monteer in omgekeerde volgorde.

4.14 LED-spot vervangen

Speciale hulpmiddelen:

Speciaal gereedschap

[00342180]



Uw apparaat heeft een onderhoudsvrije LED-verlichting. Deze verlichting mag alleen maar door de klantenservice of geautoriseerde monteurs worden vervangen!



GEVAAR

Gevaar voor een elektrische schok aan stroomvoerende onderdelen!

Levensgevaar door elektrische schokken in geval van een ondeskundige reparatie

- ▶ Elektrische onderdelen moeten door gekwalificeerde elektriciens worden gerepareerd.
- ▶ Laat na de reparatie een veiligheidstest conform VDE 0701 of de landspecifieke regelgeving uitvoeren.



GEVAAR

Gevaar voor een elektrische schok aan stroomvoerende onderdelen!

Dood door elektrocutie

- ▶ Haal apparaten minstens 60 seconden voor u met reparaties begint van de stroomvoorziening af.



VOORZICHTIG

Scherpe randen!

Snijletsel

- ▶ Draag veiligheidshandschoenen.

Voorwaarde:

- ✓ Apparaat is losgekoppeld is van de stroomvoorziening.
- ✓ Deur is open.

4.14.1 LED-verlichting verwijderen

1. Gebruik het speciale gereedschap om de LED-verlichting te vervangen (1).

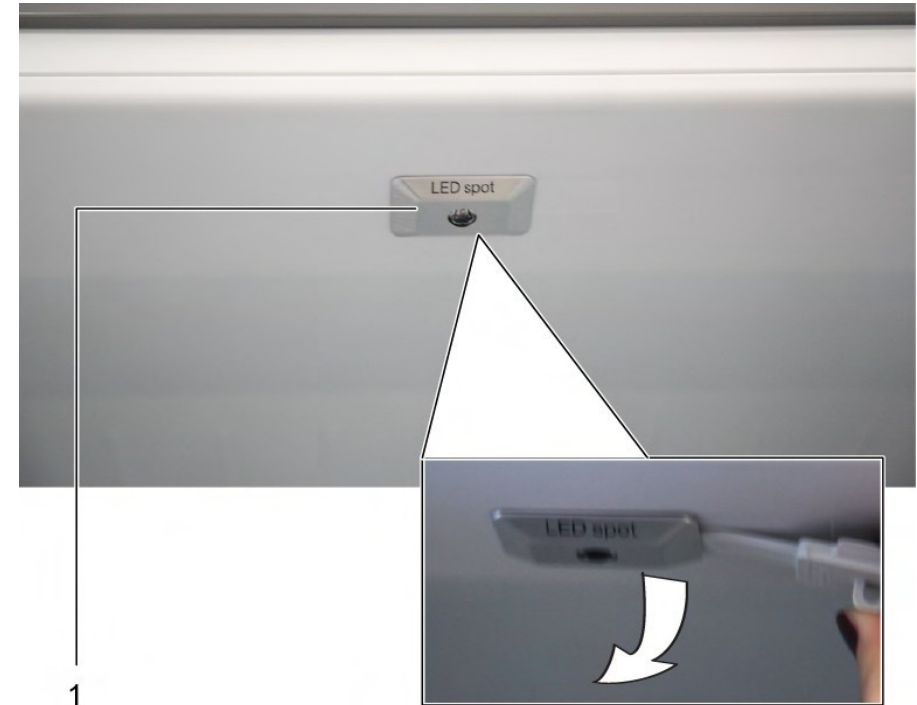

2. Haal de stekker van de elektrische aansluitingen van de LED-verlichting eruit.
➡ LED-verlichting wordt verwijderd.

4.14.2 LED-verlichting installeren

- ▶ Monteer in omgekeerde volgorde.

4.15 LED-bovenlicht vervangen

Speciale hulpmiddelen:

-  Sleufschroevendraaier Kop 2,4 mm x 0,4 mm x 60 mm, in de set [00341820]

 Uw apparaat heeft een onderhoudsvrije LED-verlichting. Deze verlichting mag alleen maar door de klantenservice of geautoriseerde monteurs worden vervangen!

 **⚠ GEVAAR**
Gevaar voor een elektrische schok aan stroomvoerende onderdelen!
Levensgevaar door elektrische schokken in geval van een ondeskundige reparatie

- ▶ Elektrische onderdelen moeten door gekwalificeerde elektriciens worden gerepareerd.
- ▶ Laat na de reparatie een veiligheidstest conform VDE 0701 of de landspecifieke regelgeving uitvoeren.

 **⚠ GEVAAR**
Gevaar voor een elektrische schok aan stroomvoerende onderdelen!
Dood door elektrocutie

- ▶ Haal apparaten minstens 60 seconden voor u met reparaties begint van de stroomvoorziening af.

 **⚠ VOORZICHTIG**
Scherpe randen!
Snijletsel

- ▶ Draag veiligheidshandschoenen.

Voorwaarde:

- ✔ Apparaat is losgekoppeld is van de stroomvoorziening.
- ✔ Deur is open.
- ✔ Het intrieur is verwijderd.

4.15.1 LED-verlichting verwijderen

1. Verplaatst de LED-verlichting naar de linkerkant.

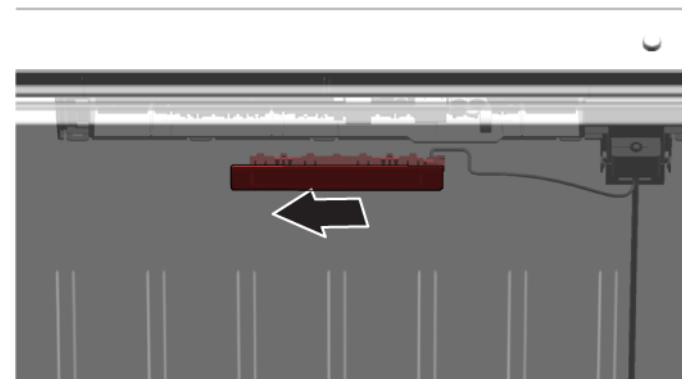

-  De elektrische aansluiting van de LED-verlichting wordt losgemaakt.

2. Haal de haken van de LED-verlichting los.

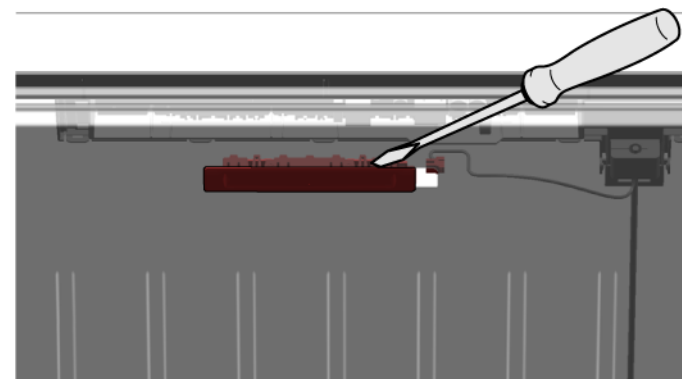

Reparatie

3. Verwijder de LED-verlichting door het naar voren te bewegen.

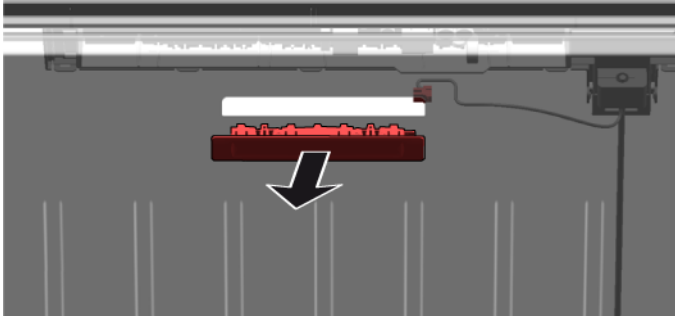

- ➔ LED-verlichting wordt verwijderd.

4.15.2 LED-bovenlicht installeren

- ▶ Monteer in omgekeerde volgorde.

4.16 LED-zijlichtbalk vervangen

Speciale hulpmiddelen:

 Zuignap Ø50 mm [00342224]

 Uw apparaat heeft een onderhoudsvrije LED-verlichting. Deze lichten mogen alleen maar door de klantenservice of geautoriseerde monteurs worden vervangen!

 **GEVAAR**
Gevaar voor een elektrische schok aan stroomvoerende onderdelen!
Levensgevaar door elektrische schokken in geval van een ondeskundige reparatie

- ▶ Elektrische onderdelen moeten door gekwalificeerde elektriciens worden gerepareerd.
- ▶ Laat na de reparatie een veiligheidstest conform VDE 0701 of de landspecifieke regelgeving uitvoeren.



 **GEVAAR**
Gevaar voor een elektrische schok aan stroomvoerende onderdelen!
Dood door elektrocutie

- ▶ Haal apparaten minstens 60 seconden voor u met reparaties begint van de stroomvoorziening af.

 **VOORZICHTIG**
Scherpe randen!
Snijletsel

- ▶ Draag veiligheidshandschoenen.

Voorwaarde:

-  Apparaat is losgekoppeld is van de stroomvoorziening.
-  Deur is open.
-  Koelvakplateaus worden verwijderd.

4.16.1 LED-zijlichtbalk verwijderen

1. Plak de zuignap op het bovenste derde deel van de LED-zijlichtbalk.



Reparatie

2. Trek de zuignap met LED-zijlichtbalk in één draaiende beweging naar voren.

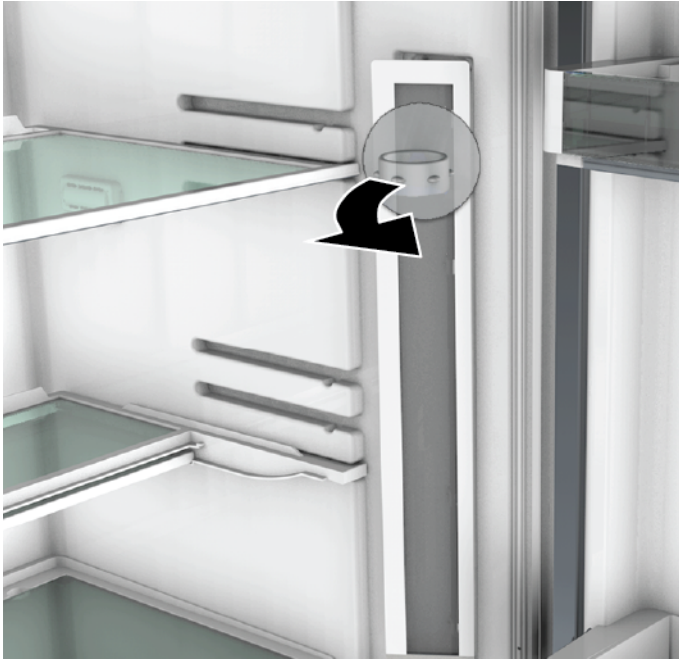



3. Haal de elektrische aansluiting van de LED-zijlichtbalk los.
 LED-zijlichtbalk wordt verwijderd.

4.16.2 LED-zijlichtbalk installeren

1. Verbind de elektrische aansluiting van de LED-zijlichtbalk.
 2. Zet de LED-zijlichtbalk op zijn plaats vast aan de wand van het vak (haak klikt vast).
-  LED-zijlichtbalk wordt geïnstalleerd.

4.17 LED-verlichting vervangen

Speciale hulpmiddelen:

-  Speciaal gereedschap [00342180]
-  Sleufschroevendraaier Kop 2,4 mm x 0,4 mm x 60 mm, in de set [00341820]

 Uw apparaat heeft een onderhoudsvrije LED-verlichting. Deze verlichting mag alleen maar door de klantenservice of geautoriseerde monteurs worden vervangen!

 **GEVAAR**
Gevaar voor een elektrische schok aan stroomvoerende onderdelen!
Levensgevaar door elektrische schokken in geval van een ondeskundige reparatie

- ▶ Elektrische onderdelen moeten door gekwalificeerde elektriciens worden gerepareerd.
- ▶ Laat na de reparatie een veiligheidstest conform VDE 0701 of de landspecifieke regelgeving uitvoeren.



 **GEVAAR**
Gevaar voor een elektrische schok aan stroomvoerende onderdelen!
Dood door elektrocutie

- ▶ Haal apparaten minstens 60 seconden voor u met reparaties begint van de stroomvoorziening af.

 **VOORZICHTIG**
Scherpe randen!
Snijletsel

- ▶ Draag veiligheidshandschoenen.

Voorwaarde:

-  Apparaat is losgekoppeld is van de stroomvoorziening.
-  Deur is open.
-  Koelvakplateaus worden verwijderd.

4.17.1 LED-verlichting verwijderen

1. Haal de afdekking van de LED-verlichting los.

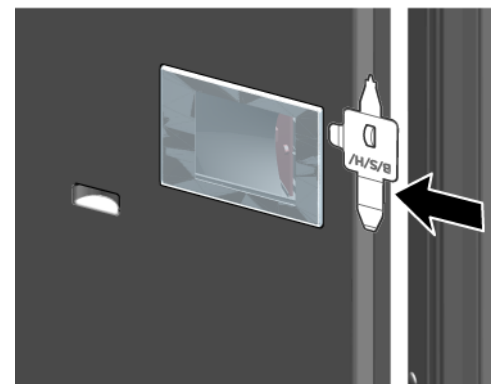

2. Trek de afdekking van de LED-verlichting naar binnen en duw deze tegelijk naar voren.

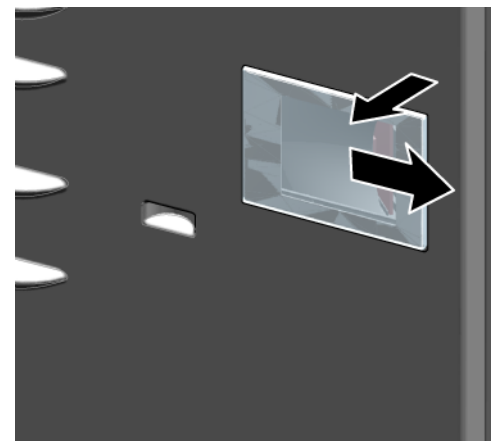

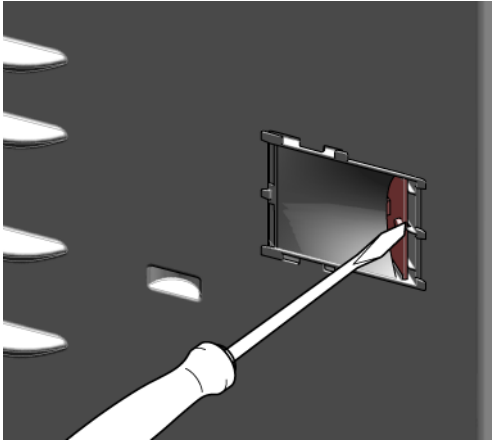

Reparatie

3. Haal de LED-verlichting los.

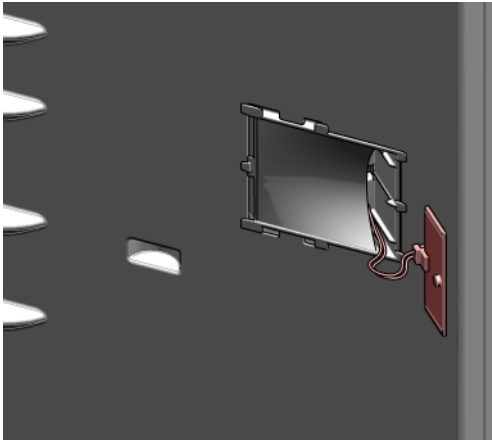

4. Haal de elektrische aansluiting van de LED-verlichting los.







 LED-verlichting wordt verwijderd.

4.17.2 LED-verlichting installeren

▶ Monteer in omgekeerde volgorde.

Repair hints - Fridge-freezer

 Concerning this document	148
1.1 Important information	148
1.1.1 Purpose.....	148
1.2 Explanation of symbols	148
1.2.1 Danger levels.....	148
1.2.2 Hazard symbols	148
1.2.3 Structure of the warnings.....	149
1.2.4 General symbols.....	149
 Safety	150
2.1 General Safety instructions	150
2.1.1 All domestic appliances	150
 Tools and aids	151
 Repair	152
4.1 Replacing door gasket	152
4.1.1 Removing door gasket.....	152
4.1.2 Installing door gasket	152
4.2 Replacing door handle	155
4.2.1 Removing door handle	155
4.2.2 Installing door handle	155
4.3 Replacing door upper hinge	156
4.3.1 Removing door upper hinge.....	156
4.3.2 Installing door upper hinge.....	157
4.4 Replacing door upper hinge (door with display)	158
4.4.1 Removing door upper hinge.....	158
4.4.2 Installing door upper hinge.....	159
4.5 Replacing door middle hinge	160
4.5.1 Removing door middle hinge	160
4.5.2 Installing door middle hinge	160
4.6 Replacing door lower hinge	161
4.6.1 Removing door lower hinge	161
4.6.2 Installing door lower hinge	161
4.7 Replacing shelf.....	162
4.7.1 Removing shelf.....	162
4.7.2 Installing shelf.....	162

4.8 Replacing bottle tray	163
4.8.1 Removing bottle tray.....	163
4.8.2 Installing bottle tray.....	163
4.9 Replacing door rack	164
4.9.1 Removing door rack.....	164
4.9.2 Installing door rack	164
4.10 Replacing adjustable door rack	165
4.10.1 Removing adjustable door rack	165
4.10.2 Installing adjustable door rack	165
4.11 Replacing frozen food container.....	166
4.11.1 Removing frozen food container	166
4.11.2 Installing frozen food container	166
4.12 Replacing container	167
4.12.1 Removing container.....	167
4.12.2 Installing container.....	167
4.13 Replacing extendable container	168
4.13.1 Removing extendable container	168
4.13.2 Installing extendable container	168
4.14 Replacing LED spot light	169
4.14.1 Removing LED spot light.....	169
4.14.2 Installing LED spot light	169
4.15 Replacing LED top light.....	170
4.15.1 Removing LED light.....	170
4.15.2 Installing top LED light	171
4.16 Replacing LED side bar light.....	172
4.16.1 Removing LED side bar light.....	172
4.16.2 Installing LED side bar light.....	173
4.17 Replacing LED spot light	174
4.17.1 Removing LED spot light.....	174
4.17.2 Installing LED spot light	175

i Concerning this document

1.1 Important information

1.1.1 Purpose

These repair hints support consumer to repair appliances by himself according to the applicable eco-design regulation (as of 03/2021).

They contain information how to exchange defined spare parts including warnings and risks.

In case of questions, please contact our customer service. We will only be liable for damages if the repair hints have been followed properly.

1.2 Explanation of symbols

1.2.1 Danger levels

The warning levels consist of a symbol and a signal word. The signal word indicates the severity of the danger.









Warning level	Meaning
	Non-observance of the warning message will result in death or serious injuries.
	Non-observance of the warning message could result in death or serious injuries.
	Non-observance of the warning message could result in minor injuries.
	Non-observance of the warning message could result in damage to property.

Table 1: Danger levels

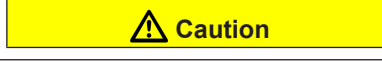
1.2.2 Hazard symbols

Hazard symbols are symbolic representations which give an indication of the kind of danger.

The following hazard symbols are used in this document:

Hazard symbol	Meaning
	General warning message
	Danger from electrical voltage
	Risk of explosion
	Danger of cuts
	Danger of crushing

i Concerning this document



Hazard symbol	Meaning
	Danger from hot surfaces
	Danger from strong magnetic field
	Danger from non-ionizing radiation

Table 2: Hazard symbols

1.2.3 Structure of the warnings

Warnings in this document have a standardised appearance and a standardised structure.



	<div style="background-color: red; color: white; padding: 2px; text-align: center;"> Danger</div> <p>Type and source of danger! Possible consequences of ignoring the danger / warning.</p> <ul style="list-style-type: none"> ▶ Measures and prohibitions for preventing the danger.
--	---

The following example shows a warning that warns against electric shock due to live parts. The measure for avoiding the danger is mentioned.

	<div style="background-color: red; color: white; padding: 2px; text-align: center;"> Danger</div> <p>Risk of electric shock due to live parts! Death by electrocution</p> <ul style="list-style-type: none"> ▶ Disconnect appliances from electrical supply at least 60 seconds before starting repairs.
---	---

1.2.4 General symbols

The following general symbols are used in this document:

Gen. symbol	Meaning
	Identification of a special tip (text and/or graphic)
	Identification of a simple tip (only text)
	Identification of a link to a video tutorial





Gen. symbol	Meaning
	Identification of required tools
	Identification of required preconditions
	Identification of a condition (if ..., then ...)
	Identification of a result
[Start]	Identification of a key or button
[00123456]	Identification of a material number
Status	Identification of displayed text / window (in the appliance's display)

Table 3: General symbols

2.1 General Safety instructions

2.1.1 All domestic appliances

Risk of electric shock due to live parts!

- Errors by repairs involving electrical components can lead to electrical shock!
- Disconnect the appliance from the mains for at least 60 seconds before starting work.
- After the repair have a safety test according VDE 0701 or country-specific regulations performed.

Risk of injury from sharp edges!

- Wear protective gloves.

Risk of crushing during repair, maintenance, troubleshooting and service due to heavy and moving components

- Wear protective shoes.
- Secure heavy components from falling down.
- Do not stick body parts into moving components.





Risk to the appliance's safety / function!

- Only use original spare parts.

Risk of damage to electrostatically sensitive components (ESDs)!

- Do not touch the modules, including connections and conductor paths.

Tools and aids

Designation	Details	Images
Protection cloth [00342013]	60 cm x 50 cm	
Slotted screwdriver	Blade 2.4 mm x 0.4 mm x 60 mm, in the kit [00341820]	
Special tool [00342180]		
Suction cup [00342224]	Ø50 mm	
Torx Bit TX20 [00340865]	6,3 mm (1/4")	
Slotted screwdriver	Blade 10 mm x 1.6 mm x 200 mm	

4.1 Replacing door gasket

Prerequisite:

-  Door is open.

4.1.1 Removing door gasket

1. Release door gasket from the groove on right and left corner.

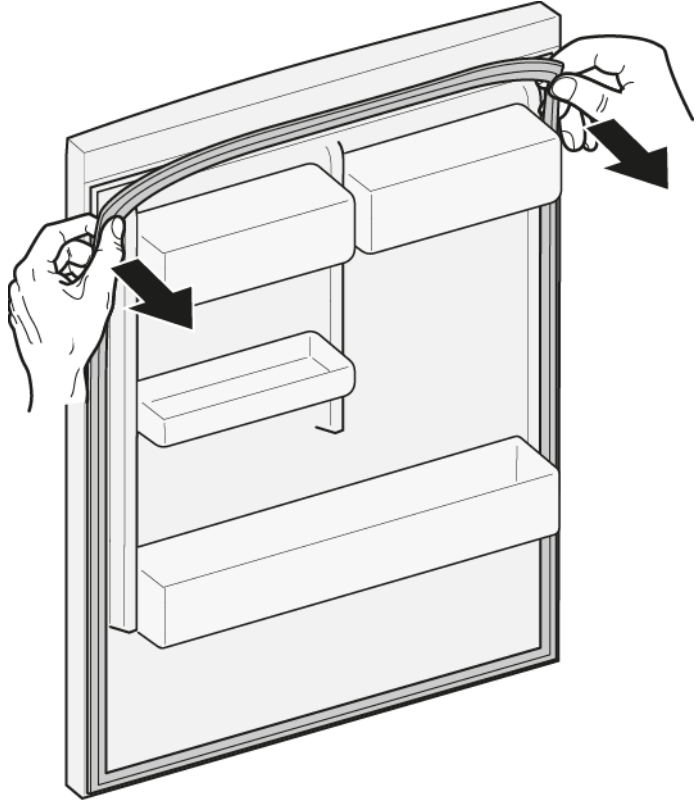

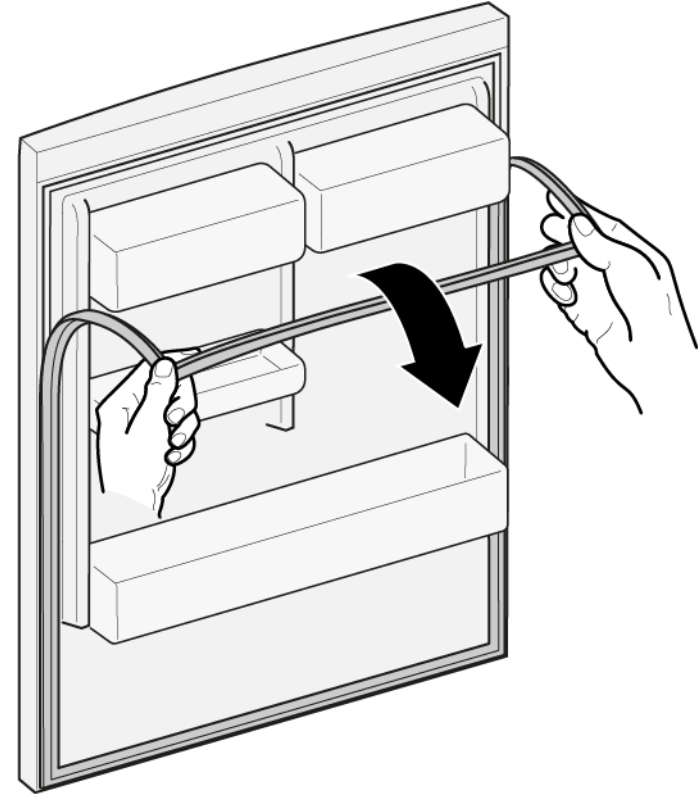

2. Pull out door gasket from groove.



-  Door gasket is removed.

4.1.2 Installing door gasket

	Thickness of new door gasket may deviate slightly from thickness of old door gasket. This will not affect closing behavior and long-term function.
	If your appliance has adjustable hinges or hinge attachments, you can optimize the closing behavior subsequently.
	Small side holes in door gasket are functional (required for ventilation). These are not production faults.

Repair

1. Check groove for gasket for damage.

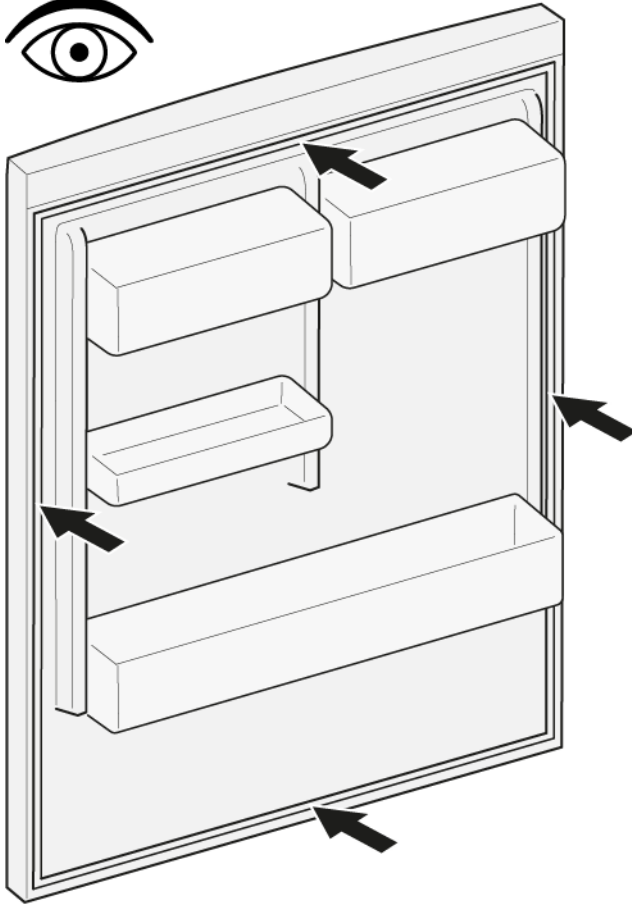

4. Push corners of gasket at the top and bottom to the groove.

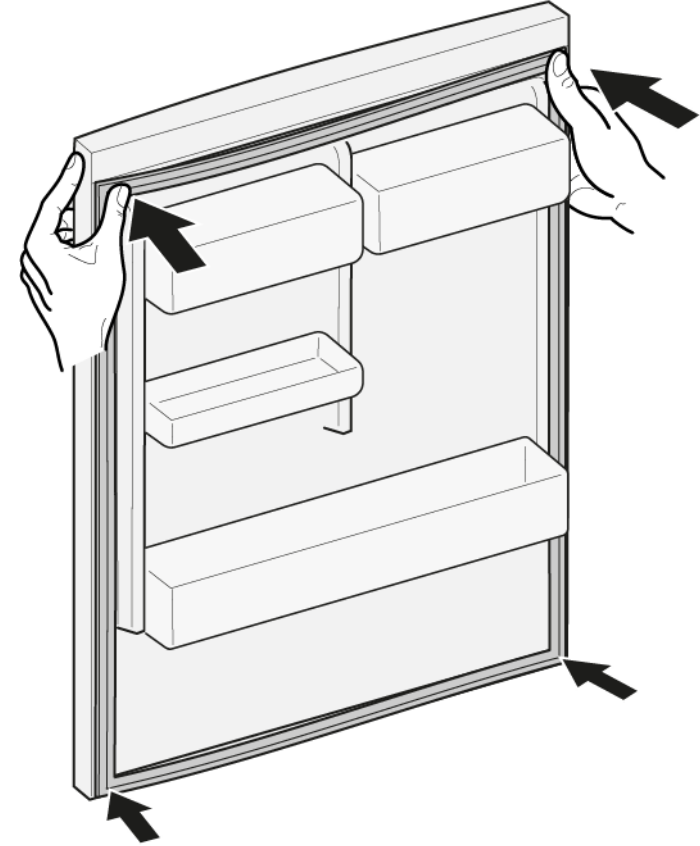



2.  If groove for gasket is it is damaged.
- Contact customer service.

3.  Slight deformation of door gasket is normal and does not affect its function. It is recommended to straighten door gasket before inserting it into appliance.

Heat door gasket with a hair dryer or hot water and manually reshape it.

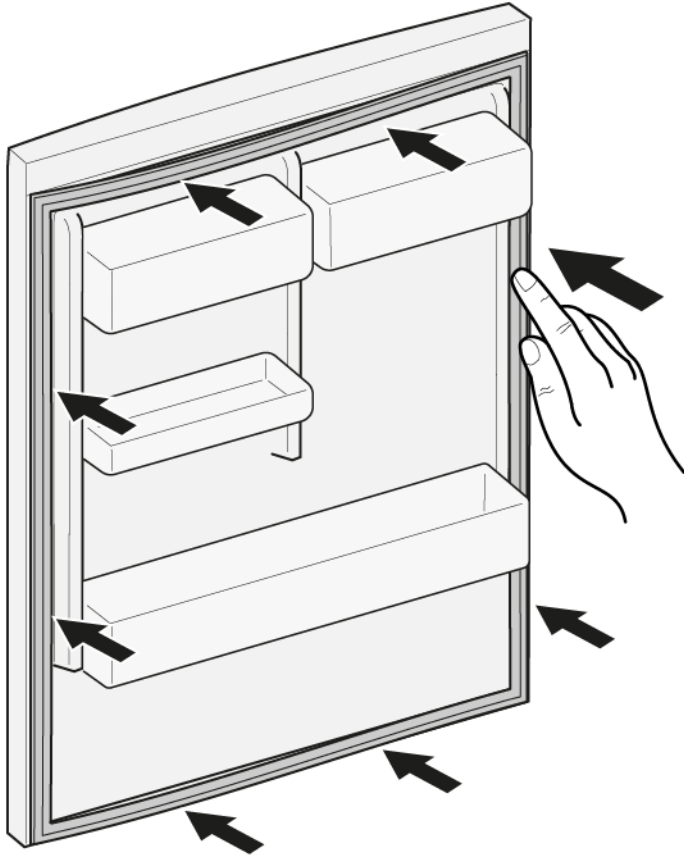

5. Press whole gasket step by step into the groove.





-  Door gasket is installed.

4.2 Replacing door handle

Required tools:

-  Torx Bit TX20 6,3 mm (1/4") [00340865]
-  Slotted screwdriver Blade 10 mm x 1.6 mm x 200 mm

Prerequisite:

-  Appliance is disconnected from power supply.
-  Door is open.

4.2.1 Removing door handle

- ▶ 1. Remove two screw caps (1).
- ▶ 2. Unscrew two screws (2).
- ▶ 3. Remove door handle (3).

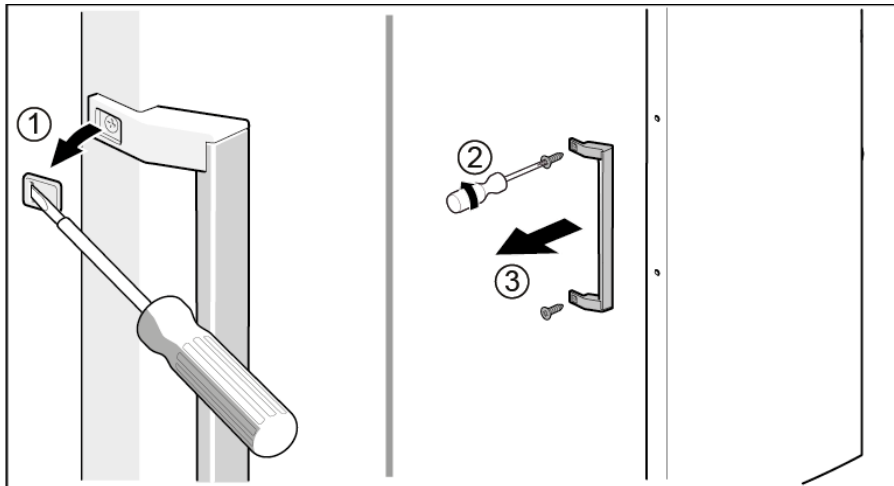

 Door handle is removed.



Door handle for the second door can be removed in the same manner.





4.2.2 Installing door handle

- ▶ Install in reverse order.



4.3 Replacing door upper hinge

Required tools:

 Torx Bit TX20 6,3 mm (1/4") [00340865]

	<p style="text-align: center;">Warning</p> <p>Heavy, bulky appliances! Back and muscle injuries</p> <ul style="list-style-type: none"> ▶ Appliance door removal operation should only be carried out by trained specialists. ▶ To move the appliance, two people are required. ▶ Use only suitable tools and equipment.
	<p style="text-align: center;">Caution</p> <p>Sharp edges! Cut injuries</p> <ul style="list-style-type: none"> ▶ Wear protective gloves.
	<p style="text-align: center;">Warning</p> <p>Slipping of tilted appliances! Bone fractures / crush injuries</p> <ul style="list-style-type: none"> ▶ Secure appliances against slipping.
	<p style="text-align: center;">Caution</p> <p>Risk of falling parts due to released screws! Injury because of falling parts.</p> <ul style="list-style-type: none"> ▶ Secure component from falling down.
	<p style="text-align: center;">Notice</p> <p>Risk of falling parts due to released screws! Damage to other parts of the appliance or at customers home e.g. bottom.</p> <ul style="list-style-type: none"> ▶ Secure component from falling down.

Prerequisite:

-  Appliance is disconnected from power supply.
-  Appliance interior fittings are removed.

4.3.1 Removing door upper hinge

1. Place appliance on the back side.

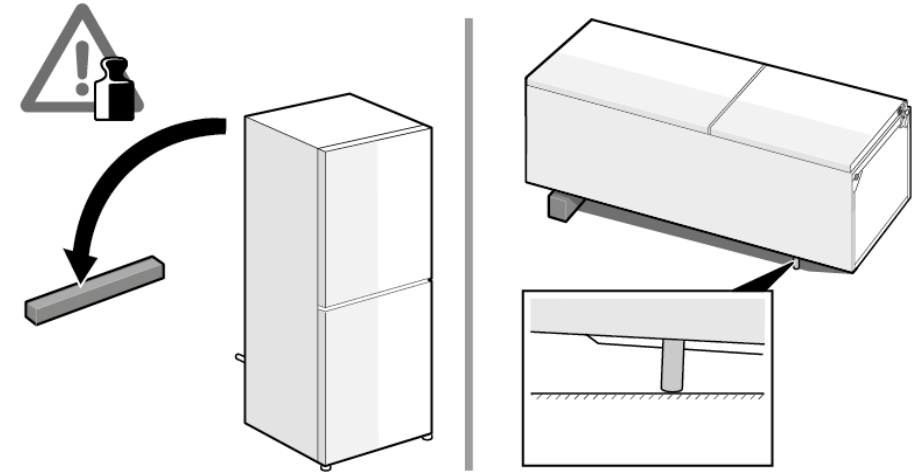

Repair

2. 1. Press upper hinge cover on both sides (1).
2. Move out upper hinge cover (2).
3. Rotate hinge cover (3).
4. Remove upper hinge cover (4).
5. Unscrew two screws (5).
6. Remove upper hinge (6).

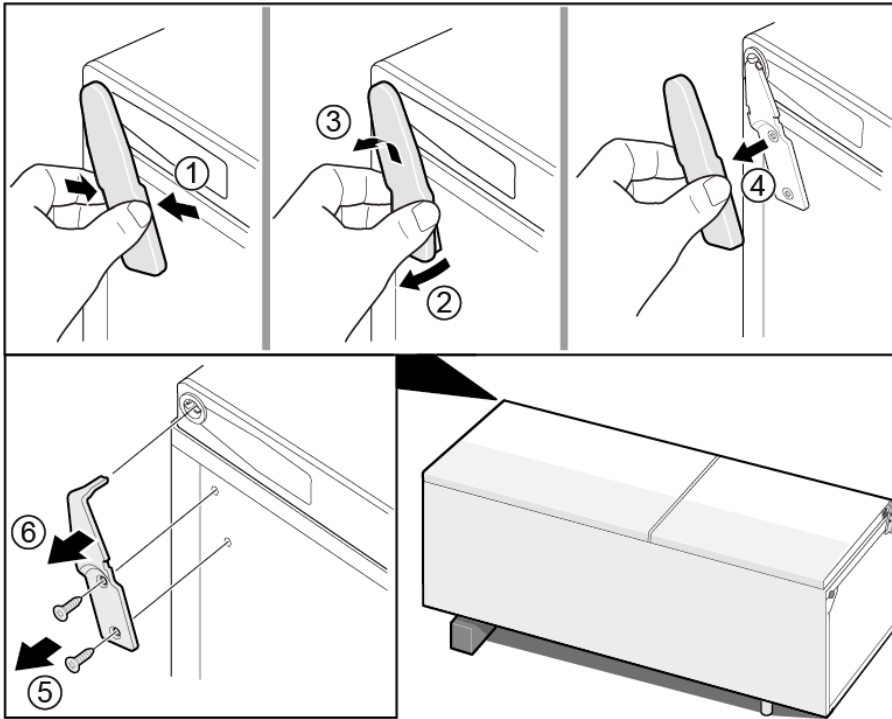

 Upper hinge is removed.

4.3.2 Installing door upper hinge

- ▶ Install in reverse order.

4.4 Replacing door upper hinge (door with display)

Required tools:

 Torx Bit TX20 6,3 mm (1/4") [00340865]

	Warning
	<p>Heavy, bulky appliances! Back and muscle injuries</p> <ul style="list-style-type: none"> ▶ Appliance door removal operation should only be carried out by trained specialists. ▶ To move the appliance, two people are required. ▶ Use only suitable tools and equipment.

	Caution
	<p>Sharp edges! Cut injuries</p> <ul style="list-style-type: none"> ▶ Wear protective gloves.

	Warning
	<p>Slipping of tilted appliances! Bone fractures / crush injuries</p> <ul style="list-style-type: none"> ▶ Secure appliances against slipping.



	Caution
	<p>Risk of falling parts due to released screws! Injury because of falling parts.</p> <ul style="list-style-type: none"> ▶ Secure component from falling down.

	Notice
	<p>Risk of falling parts due to released screws! Damage to other parts of the appliance or at customers home e.g. bottom.</p> <ul style="list-style-type: none"> ▶ Secure component from falling down.

	Danger
	<p>Risk of electric shock due to live parts! Danger to life through electric shock in case of improper repair</p> <ul style="list-style-type: none"> ▶ Electric parts should be repaired by a qualified electricians. ▶ After the repair have a safety test according VDE 0701 or country-specific regulations performed.

	Danger
	<p>Risk of electric shock due to live parts! Death by electrocution</p> <ul style="list-style-type: none"> ▶ Disconnect appliances from electrical supply at least 60 seconds before starting repairs.

Prerequisite:

-  Appliance is disconnected from power supply.
-  Appliance interior fittings are removed.

4.4.1 Removing door upper hinge

1. Place appliance on the back side.

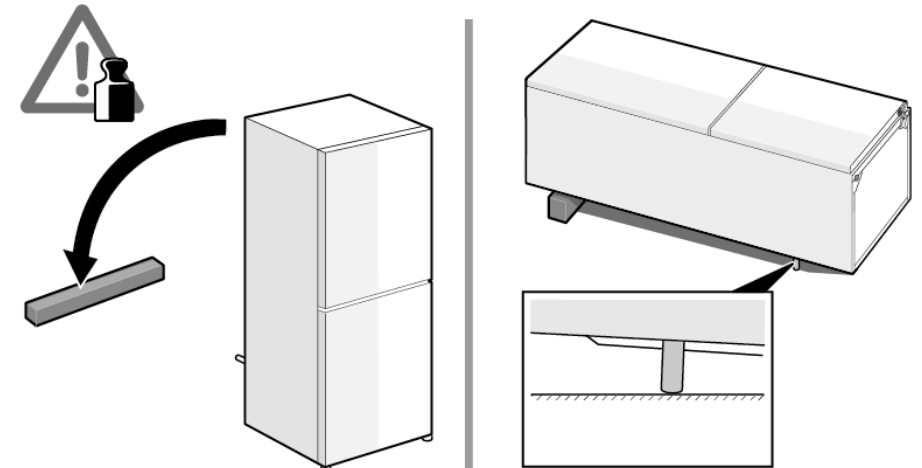

Repair

2. 1. Remove upper hinge cover (1).
2. Remove cable box cover (2).
3. Disconnect electrical connection (3).
4. Unscrew ground connection screw (4).
5. Remove cable protection (5).
6. Unscrew the screw (6)

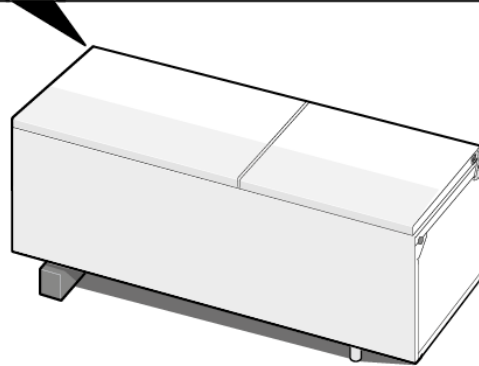
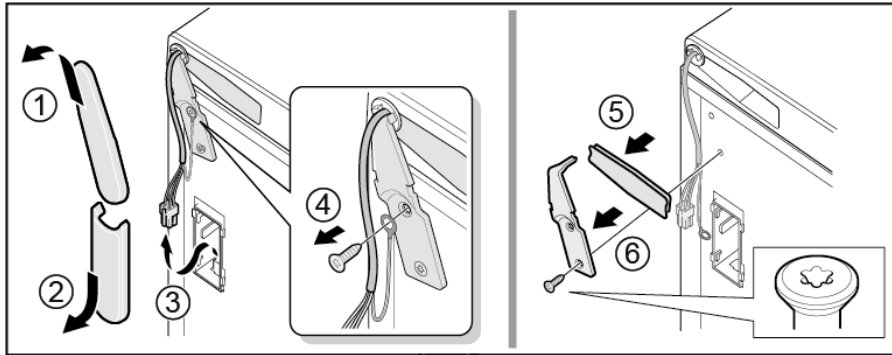

 Upper hinge is removed.

4.4.2 Installing door upper hinge

- ▶ Install in reverse order.

4.5 Replacing door middle hinge

Required tools:

 Torx Bit TX20 6,3 mm (1/4") [00340865]



Warning

Heavy, bulky appliances!

Back and muscle injuries

- ▶ Appliance door removal operation should only be carried out by trained specialists.
- ▶ To move the appliance, two people are required.
- ▶ Use only suitable tools and equipment.



Caution

Sharp edges!

Cut injuries

- ▶ Wear protective gloves.



Warning

Slipping of tilted appliances!

Bone fractures / crush injuries

- ▶ Secure appliances against slipping.



Caution

Risk of falling parts due to released screws!

Injury because of falling parts.

- ▶ Secure component from falling down.





Notice

Risk of falling parts due to released screws!

Damage to other parts of the appliance or at customers home e.g. bottom.

- ▶ Secure component from falling down.

Prerequisite:

-  Appliance is disconnected from power supply.
-  Appliance interior fittings are removed.
-  Door upper hinge is removed.

4.5.1 Removing door middle hinge

- ▶ 1. Remove fridge compartment door (1).
- ▶ 2. Unscrew two screws (2).
- ▶ 3. Remove middle hinge (3).

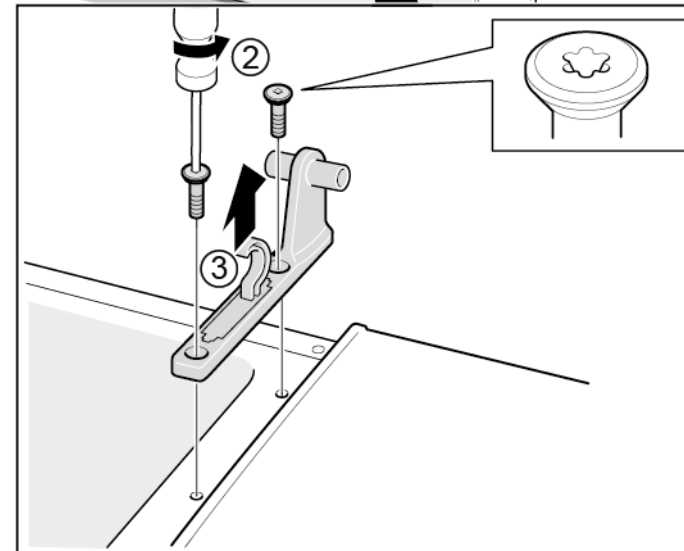
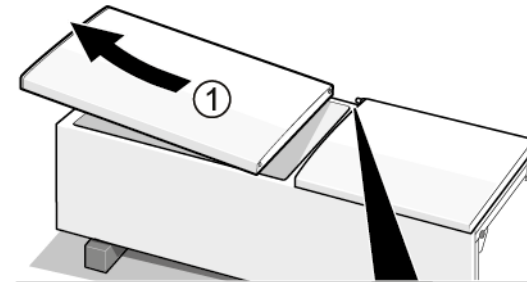

 Middle hinge is removed.





4.5.2 Installing door middle hinge

- ▶ Install in reverse order.



4.6 Replacing door lower hinge

Required tools:

 Torx Bit TX20 6,3 mm (1/4") [00340865]

	Warning
	<p>Heavy, bulky appliances! Back and muscle injuries</p> <ul style="list-style-type: none"> ▶ Appliance door removal operation should only be carried out by trained specialists. ▶ To move the appliance, two people are required. ▶ Use only suitable tools and equipment.
	Caution
	<p>Sharp edges! Cut injuries</p> <ul style="list-style-type: none"> ▶ Wear protective gloves.
	Warning
	<p>Slipping of tilted appliances! Bone fractures / crush injuries</p> <ul style="list-style-type: none"> ▶ Secure appliances against slipping.
	Caution
	<p>Risk of falling parts due to released screws! Injury because of falling parts.</p> <ul style="list-style-type: none"> ▶ Secure component from falling down.
	Notice
	<p>Risk of falling parts due to released screws! Damage to other parts of the appliance or at customers home e.g. bottom.</p> <ul style="list-style-type: none"> ▶ Secure component from falling down.

Prerequisite:

-  Appliance is disconnected from power supply.
-  Appliance interior fittings are removed.
-  Upper hinge is removed.

 Middle hinge is removed.

4.6.1 Removing door lower hinge

- ▶ 1. Remove freezer compartment door (1).
- ▶ 2. Unscrew the screw (2).
- ▶ 3. Turn lower hinge out (3).
- ▶ 4. Remove lower hinge (4).

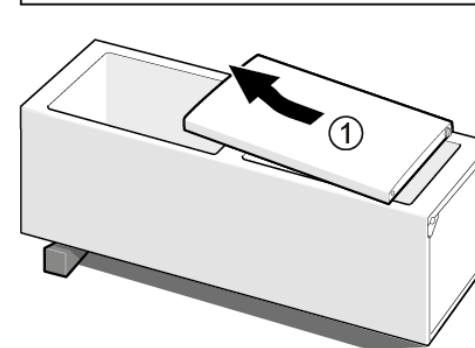
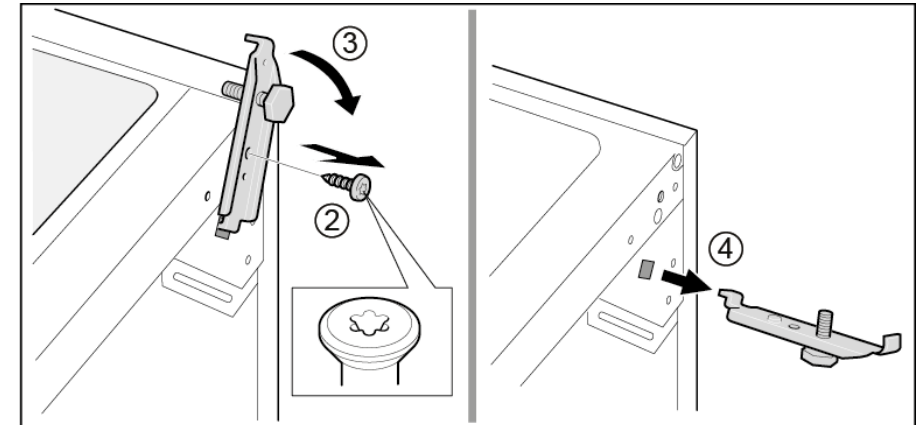

 Door lower hinge is removed.

4.6.2 Installing door lower hinge

- ▶ Install in reverse order.

4.7 Replacing shelf

Prerequisite:

- ✔ Door is open.

4.7.1 Removing shelf

- ▶ Pull out shelf.

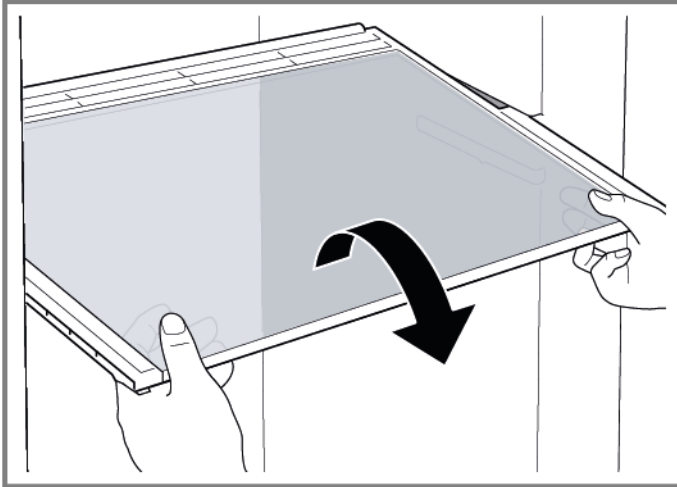

- ➡ Shelf is removed.

4.7.2 Installing shelf

- ▶ Install in reverse order.

4.8 Replacing bottle tray

Prerequisite:

- ✔ Door is open.

4.8.1 Removing bottle tray

- ▶ Pull out bottle tray.

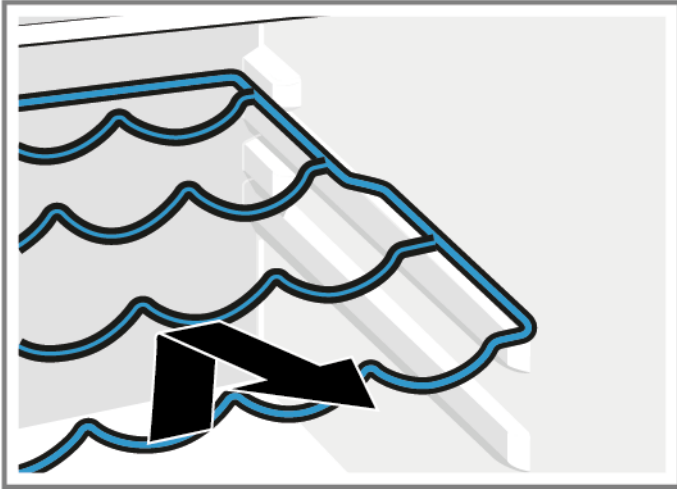

- ➡ Bottle tray is removed.

4.8.2 Installing bottle tray

- ▶ Install in reverse order.

4.9 Replacing door rack

Prerequisite:

- ✔ Door is open.

4.9.1 Removing door rack

- ▶ Lift door rack upwards.

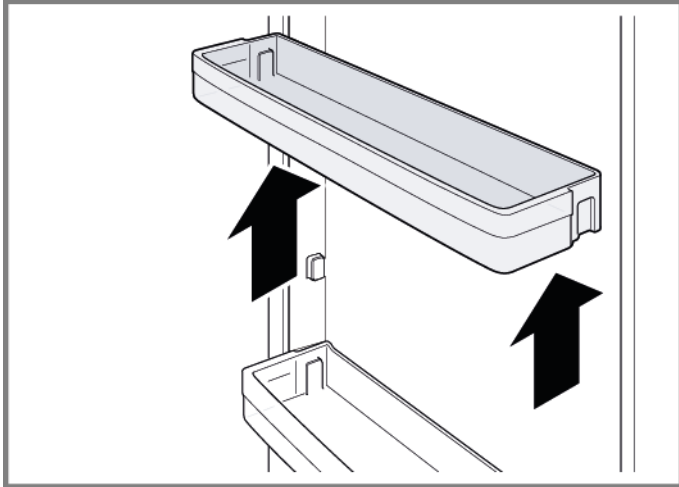

- ➡ Door rack is removed.

4.9.2 Installing door rack

- ▶ Install in reverse order.

4.10 Replacing adjustable door rack

Prerequisite:

- ✔ Door is open.

4.10.1 Removing adjustable door rack

- ▶ Move high-adjustable door rack upwards until the door rack is released from the holder.

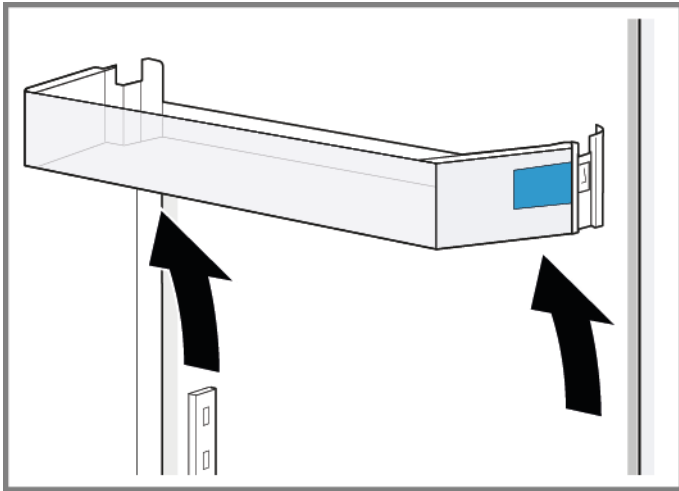

- ➡ Adjustable door rack is removed.

4.10.2 Installing adjustable door rack

- ▶ Install in reverse order.

4.11 Replacing frozen food container

Prerequisite:

- ✔ Door is open.

4.11.1 Removing frozen food container

- ▶ 1. Pull out frozen food container all the way (1).
- ▶ 2. Remove food container (2).

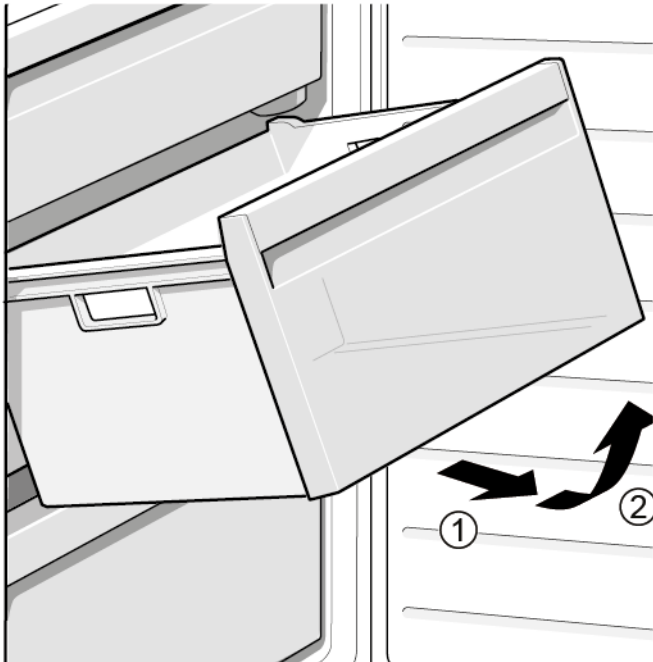

- ➡ Frozen food container is removed.

4.11.2 Installing frozen food container

- ▶ Install in reverse order.

4.12 Replacing container

Prerequisite:

- ✔ Door is open.

4.12.1 Removing container

- ▶ 1. Move out lower fridge container (1).
- ▶ 2. Move out upper fridge container (2).

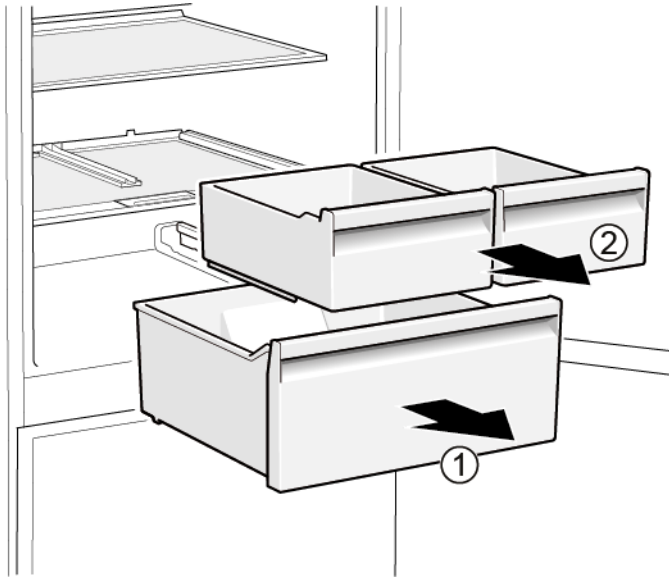

- ➡ Containers are removed.

4.12.2 Installing container

- ▶ Install in reverse order.

4.13 Replacing extendable container

Prerequisite:

- ✔ Door is open.

4.13.1 Removing extendable container

- ▶ 1. Pull extendable container out all the way (1).
- ▶ 2. Remove extendable container (2).

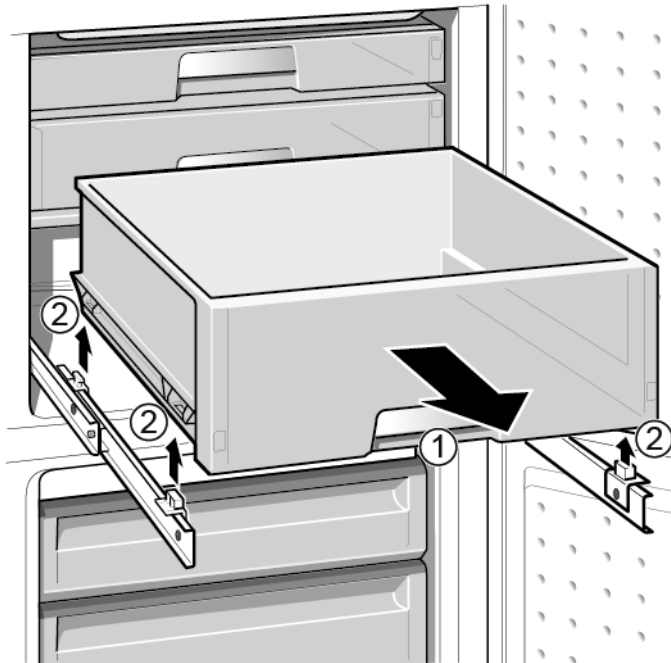

- ➡ Extendable container is removed.

4.13.2 Installing extendable container

- ▶ Install in reverse order.

4.14 Replacing LED spot light

Required tools:

 Special tool [00342180]



Your appliance features a maintenance-free LED light. These lights may be repaired by customer service or authorised technicians only!



Danger

Risk of electric shock due to live parts!

Danger to life through electric shock in case of improper repair

- ▶ Electric parts should be repaired by a qualified electrician.
- ▶ After the repair have a safety test according to VDE 0701 or country-specific regulations performed.



Danger

Risk of electric shock due to live parts!

Death by electrocution

- ▶ Disconnect appliances from electrical supply at least 60 seconds before starting repairs.





Caution

Sharp edges!

Cut injuries

- ▶ Wear protective gloves.

Prerequisite:

-  Appliance is disconnected from power supply.
-  Door is open.

4.14.1 Removing LED spot light

1. Use special tool to pull out LED spot light (1).

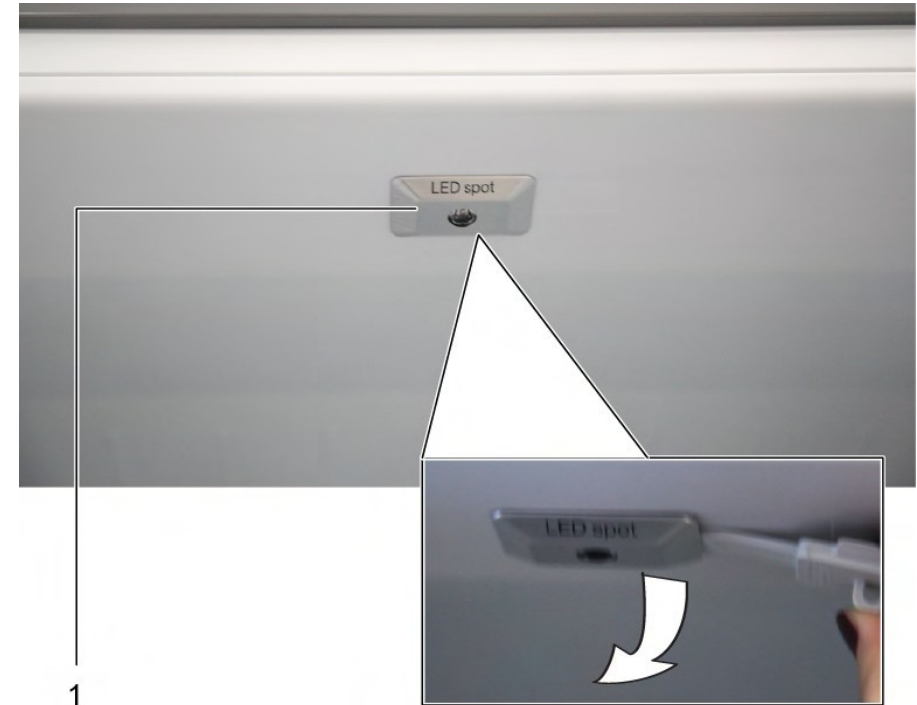

2. Unplug electrical connections of LED spot light.
 LED spot light is removed.

4.14.2 Installing LED spot light

- ▶ Install in reverse order.

4.15 Replacing LED top light

Required tools:

-  Slotted screwdriver Blade 2.4 mm x 0.4 mm x 60 mm, in the kit [00341820]



	Your appliance features a maintenance-free LED light. These lights may be repaired by customer service or authorised technicians only!
---	--

	⚠ Danger
	Risk of electric shock due to live parts! Danger to life through electric shock in case of improper repair <ul style="list-style-type: none"> ▶ Electric parts should be repaired by a qualified electrician. ▶ After the repair have a safety test according VDE 0701 or country-specific regulations performed.

	⚠ Danger
	Risk of electric shock due to live parts! Death by electrocution <ul style="list-style-type: none"> ▶ Disconnect appliances from electrical supply at least 60 seconds before starting repairs.

	⚠ Caution
	Sharp edges! Cut injuries <ul style="list-style-type: none"> ▶ Wear protective gloves.

Prerequisite:

-  Appliance is disconnected from power supply.
-  Door is open.
-  Upper interior fittings are removed.

4.15.1 Removing LED light

1. Move the LED light to the left side.

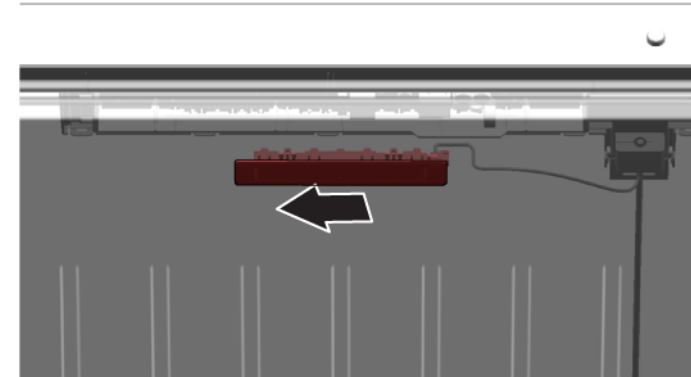

-  LED light electrical connection is disconnected.

2. Release LED light hooks.

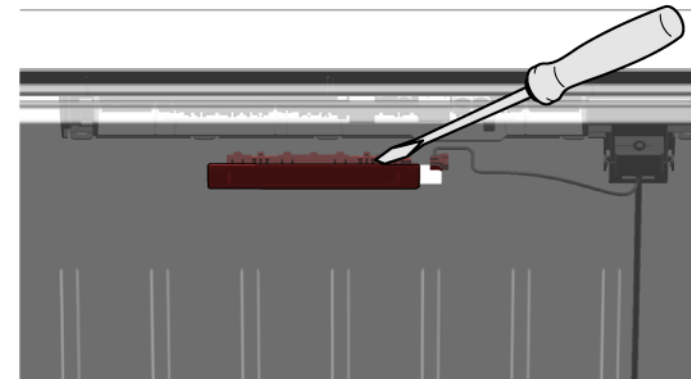

3. Remove LED light moving it forward.

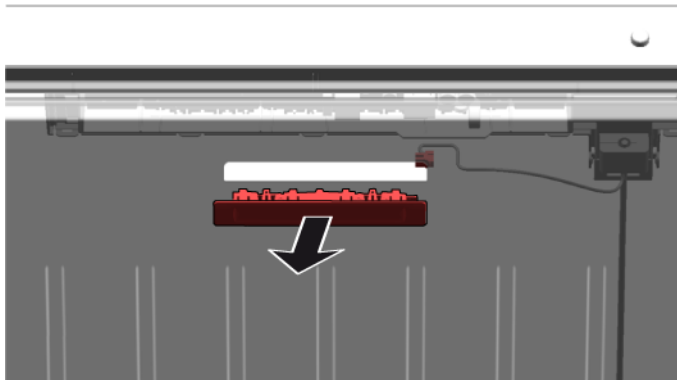

- ➔ LED light is removed.

4.15.2 Installing top LED light

- ▶ Install in reverse order.

4.16 Replacing LED side bar light

Required tools:

 Suction cup Ø50 mm [00342224]



Your appliance features a maintenance-free LED light. These lights may be repaired by customer service or authorised technicians only!



Danger

Risk of electric shock due to live parts!

Danger to life through electric shock in case of improper repair

- ▶ Electric parts should be repaired by a qualified electrician.
- ▶ After the repair have a safety test according to VDE 0701 or country-specific regulations performed.



Danger

Risk of electric shock due to live parts!

Death by electrocution

- ▶ Disconnect appliances from electrical supply at least 60 seconds before starting repairs.





Caution

Sharp edges!

Cut injuries

- ▶ Wear protective gloves.

Prerequisite:

-  Appliance is disconnected from power supply.
-  Door is open.
-  Fridge compartment shelves are removed.

4.16.1 Removing LED side bar light

1. Stick the suction cup on the upper third of LED side bar light.



2. Pull suction cup with forward LED side bar light in one rotary movement.

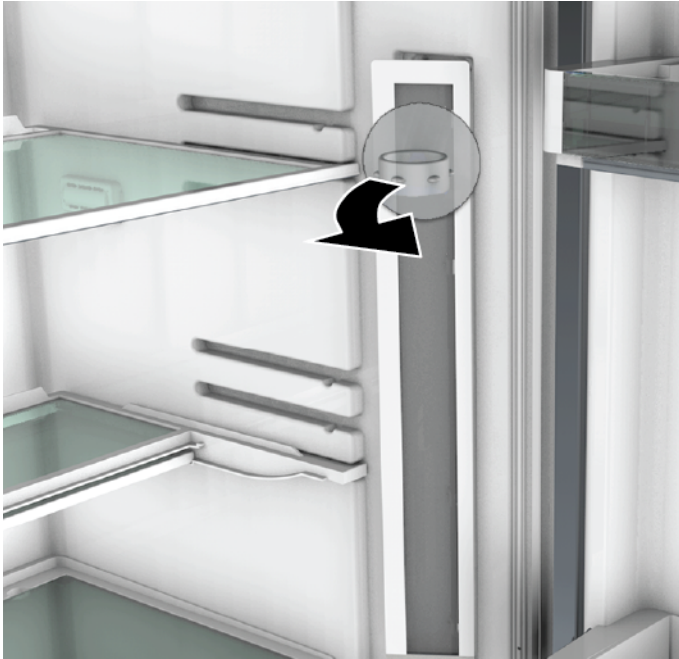



3. Disconnect electrical connection of LED side bar light.
➡ LED side bar light is removed.

4.16.2 Installing LED side bar light

1. Connect electrical connection of LED side bar light.
 2. Fix LED side bar light into it's location on compartment wall (hooks click).
- ➡ LED side bar light is installed.

4.17 Replacing LED spot light

Required tools:

-  Special tool [00342180]
-  Slotted screwdriver Blade 2.4 mm x 0.4 mm x 60 mm, in the kit [00341820]



Your appliance features a maintenance-free LED light. These lights may be repaired by customer service or authorised technicians only!



Danger

Risk of electric shock due to live parts!

Danger to life through electric shock in case of improper repair

- ▶ Electric parts should be repaired by a qualified electrician.
- ▶ After the repair have a safety test according VDE 0701 or country-specific regulations performed.



Danger

Risk of electric shock due to live parts!

Death by electrocution

- ▶ Disconnect appliances from electrical supply at least 60 seconds before starting repairs.





Caution

Sharp edges!

Cut injuries

- ▶ Wear protective gloves.

Prerequisite:

-  Appliance is disconnected from power supply.
-  Door is open.
-  Fridge compartment shelves are removed.

4.17.1 Removing LED spot light

1. Release LED spot light cover.

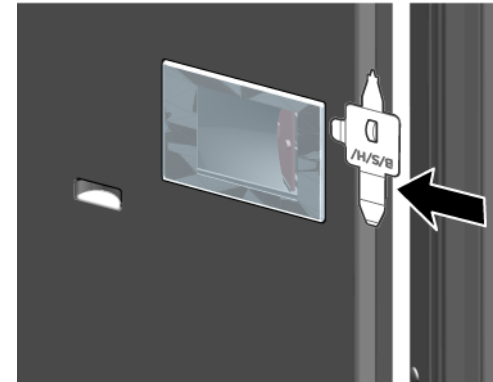

2. Pull LED spot light cover inwards and simultaneously push forwards.

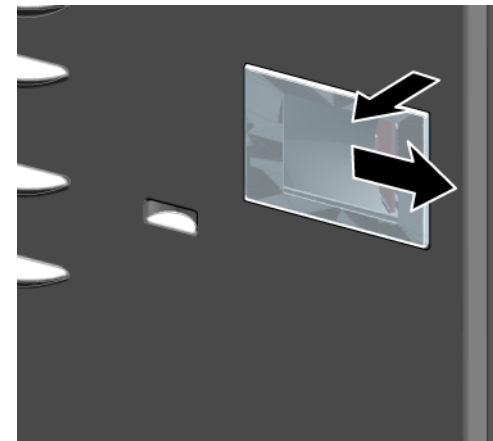

3. Detach LED spot light module.

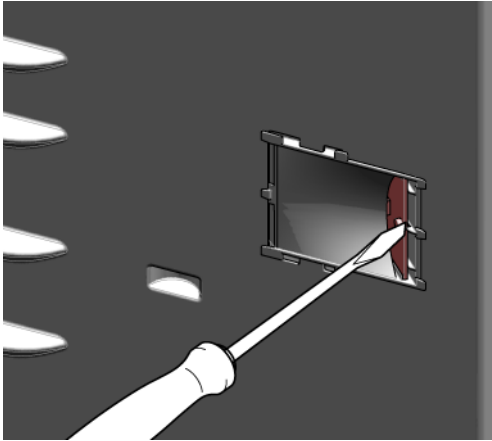

4. Disconnect LED spot light electrical connection.

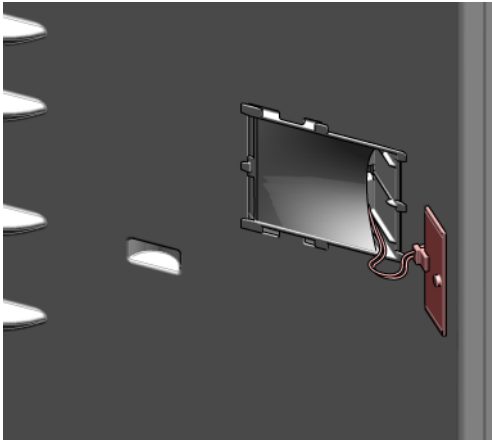

- ➡ LED spot light is removed.

4.17.2 Installing LED spot light

- ▶ Install in reverse order.

Remonditeave - Kombikülmik

 Selle dokumendiga seoses	177
1.1 Tähtis teave	177
1.1.1 Eesmärk.....	177
1.2 Sümbolite selgitus	177
1.2.1 Ohutasemed.....	177
1.2.2 Ohusümbolid	177
1.2.3 Hoiatuste struktuur.....	178
1.2.4 Üldised sümbolid.....	178
 Ohutus.....	179
2.1 Üldised ohutusjuhised.....	179
2.1.1 Kõik kodumasinad.....	179
 Tööriistad ja abinõud.....	180
 Remont.....	181
4.1 Uksetihendi vahetamine.....	181
4.1.1 Uksetihendi eemaldamine	181
4.1.2 Uksetihendi paigaldamine.....	181
4.2 Käepideme vahetamine	184
4.2.1 Käepideme eemaldamine	184
4.2.2 Käepideme paigaldamine	184
4.3 Ülemise uksehinge vahetamine	185
4.3.1 Ülemise uksehinge eemaldamine.....	185
4.3.2 Ülemise uksehinge paigaldamine.....	186
4.4 Ülemise uksehinge vahetamine (uks koos kuvaga).....	187
4.4.1 Ülemise uksehinge eemaldamine.....	187
4.4.2 Ülemise uksehinge paigaldamine.....	188
4.5 Keskmise uksehinge vahetamine.....	189
4.5.1 Keskmise uksehinge eemaldamine	189
4.5.2 Keskmise uksehinge paigaldamine	189
4.6 Alumise uksehinge vahetamine	190
4.6.1 Alumise uksehinge eemaldamine.....	190
4.6.2 Alumise uksehinge paigaldamine	190
4.7 Riiuli vahetamine	191
4.7.1 Riiuli eemaldamine.....	191
4.7.2 Riiuli paigaldamine	191

4.8 Pudelialuse vahetamine	192
4.8.1 Pudelialuse eemaldamine	192
4.8.2 Pudelialuse paigaldamine	192
4.9 Ukseraami vahetamine.....	193
4.9.1 Ukseraami eemaldamine	193
4.9.2 Ukseraami paigaldamine.....	193
4.10 Reguleeritava ukseraami vahetamine.....	194
4.10.1 Reguleeritava ukseraami eemaldamine	194
4.10.2 Reguleeritava ukseraami paigaldamine.....	194
4.11 Külmutatud toidu mahuti vahetamine.....	195
4.11.1 Külmutatud toidu mahuti eemaldamine	195
4.11.2 Külmutatud toidu mahuti paigaldamine	195
4.12 Mahuti vahetamine.....	196
4.12.1 Mahuti eemaldamine	196
4.12.2 Mahuti paigaldamine.....	196
4.13 Laiendatava mahuti vahetamine	197
4.13.1 Laiendatava mahuti eemaldamine	197
4.13.2 Laiendatava mahuti paigaldamine	197
4.14 LED-kohtvalgusti vahetamine	198
4.14.1 LED-kohtvalgusti eemaldamine	198
4.14.2 LED-kohtvalgusti paigaldamine	198
4.15 Ülemise LED-tule vahetamine.....	199
4.15.1 LED-tule eemaldamine	199
4.15.2 Ülemise LED-tule paigaldamine.....	200
4.16 Külgmise LED-valgusriba vahetamine	201
4.16.1 Külgmise LED-valgusriba eemaldamine.....	201
4.16.2 Külgmise LED-valgusriba paigaldamine	202
4.17 LED-kohtvalgusti vahetamine	203
4.17.1 LED-kohtvalgusti eemaldamine	203
4.17.2 LED-kohtvalgusti paigaldamine	204

i Selle dokumendiga seoses

1.1 Tähtis teave

1.1.1 Eesmärk

Need remondinõuanded toetavad tarbijat seadmete iseseisval remontimisel vastavalt kehtivale ökodisaini määrusele (03/2021).





Need sisaldavad teavet selle kohta, kuidas vahetada teatud varuosi, samuti hoiatusi ning ohtusid.

Küsimuste korral võtke ühendust meie klienditeenindusega. Meie vastutame kahjustuste eest ainult siis, kui remondinõuandeid on õigesti järgitud.

1.2 Sümbolite selgitus

1.2.1 Ohutasemed

Ohutasemed koosnevad sümbolist ja märksõnast. Märksõna viitab ohu raskusastmele.

Hoiatustase	Tähendus
 OHT	Hoiatusteadete eiramine põhjustab surma või raskeid kehavigastusi.
 HOIATUS	Hoiatusteadete eiramine võib põhjustada surma või raskeid kehavigastusi.
 ETTEVAATUST!	Hoiatusteadete eiramine võib põhjustada kergeid kehavigastusi.
 TÄHELEPANU!	Hoiatusteadete eiramine võib põhjustada varakahju.

Tabel 1: Ohutasemed



1.2.2 Ohusümbolid

Ohusümbolid on sümboolsed kujutised, mis viitavad ohu laadile.

Selles dokumendis kasutatakse alljärgnevaid ohusümboleid.

Ohusümbol	Tähendus
	Üldine ohuteade
	Elektripingest tingitud oht
	Plahvatusoht
	Lõikeoht
	Muljumisoht

i Selle dokumendiga seoses

Ohusümbol	Tähendus
	Kuumadest pindadest tingitud oht
	Tugevast magnetväljast tingitud oht
	Mitteioniseerivast kiirgusest tingitud oht

Tabel 2: Ohusümbolid

1.2.3 Hoiatuste struktuur

Selles dokumendis olevatel hoiatustel on standardiseeritud väljanägemine ja standardiseeritud struktuur.



	<div style="background-color: red; color: white; padding: 2px; display: inline-block;">⚠ OHT</div> Ohu tüüp ja allikas! Ohu/hoiatuse eiramise võimalikud tagajärjed. ▶ Meetmed ja ettevaatusabinõud ohu vältimiseks.
--	---





Alljärgnevas näiteks on näidatud hoiatust, millega hoiatatakse liikuvatest osadest tingitud elektrilöögiu eest. Nimetatud on meetet ohu vältimiseks.

	<div style="background-color: red; color: white; padding: 2px; display: inline-block;">⚠ OHT</div> Liikuvatest osadest tingitud elektrilöögi oht! Elektrilöögist tingitud surm ▶ Enne remonditöödega alustamist ühendage seadmed elektrivõrgust lahti vähemalt 60 sekundit varem.
---	--

1.2.4 Üldised sümbolid

Selles dokumendis kasutatakse alljärgnevaid üldisi sümboleid.

Üld. sümbol	Tähendus
	Erinõuande tunnus (tekst ja/või graafik)
	Lihtsa nõuande tunnus (ainult tekst)
	Videojuhendi lingi tunnus

Üld. sümbol	Tähendus
	Vajalike tööriistade tunnus
	Vajalike eeltingimuste tunnus
	Seisukorra tunnus (kui..., siis...)
	Tulemuse tunnus
[Start]	Klahvi või nupu tunnus
[00123456]	Materjalinumbr tunnus
Olek	Kuvatava teksti/akna tunnus (seadme ekraanil)

Tabel 3: Üldised sümbolid

2.1 Üldised ohutusjuhised

2.1.1 Kõik kodumasinad

Liikuvatest osadest tingitud elektrilöögi oht!

- Elektriliste osade remondil tehtud vead võivad põhjustada elektrilööki!
- Lahutage seade vooluvõrgust vähemalt 60 sekundit enne tööle hakkamist.
- Pärast remonti peab olema tehtud ohutuskatse vastavalt standardile VDE 0701 või riiklikele määrustele.

Teravatest servadest tingitud vigastusoht!

- Kandke kaitsekindaid.

Rasketest ja liikuvatest osadest tingitud muljumisoht remondi-, puhastustööde, tõrkeotsingu ja hoolduse käigus

- Kandke turvakingi.
- Kinnitage rasked osad allakukkumise vastu.
- Ärge toppige kehaosi liikuvate osade vahele.





Oht seadme ohutusele/talitlusele!

- Kasutage ainult originaalvaruosasid.

Elektrostaatiliselt tundlike osade (ESD) kahjustamise oht!

- Ärge puudutage moduleid, kaasa arvatud ühendusi ega transportöörlinte.

Tööriistad ja abinõud

Määramine	Üksikasjad	Kujutised
Kaitseriie [00342013]	60 cm × 50 cm	
Lapik kruvikeeraja	Tera 2,4 mm × 0,4 mm × 60 mm, komplektis [00341820]	
Eritööriist [00342180]		
Iminapp [00342224]	Ø50 mm	
Tähtotsik TX20 [00340865]	6,3 mm (1/4 tolli)	
Lapik kruvikeeraja	Tera 10 mm × 1,6 mm × 200 mm	

4.1 Uksetihendi vahetamine

Nõue:

- ✓ Uks on lahti.

4.1.1 Uksetihendi eemaldamine

1. Vabastage uksetihend soonest paremast ja vasakust nurgast.





2. Tõmmake uksetihend soonest välja.



- ➡ Uksetihend on eemaldatud.

4.1.2 Uksetihendi paigaldamine

	Uue uksetihendi paksus võib veidi erineda vana tihendi paksusest. See ei mõjuta ukse sulgemist ja pikaajalist tööd.
	Kui teie seadmel on reguleeritavad hinged või hingekinnitused, saate sulgemismehhanismi hiljem sobivaks sättida.
	Väikesed augud uksetihendis on vajalikud õhutuseks. Need ei ole tootmisvead.

1. Kontrollige, kas tihendi soon on terve.

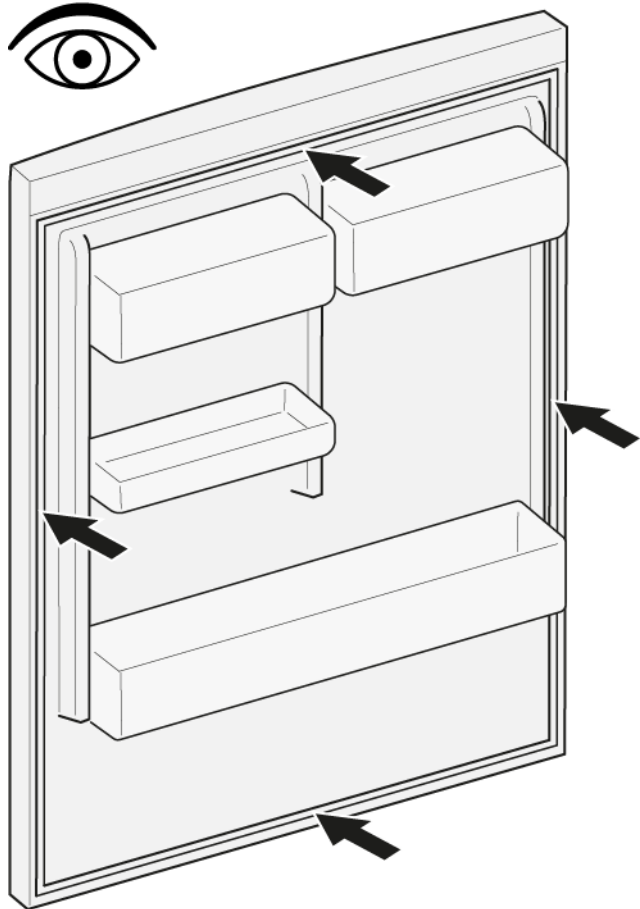

4. Lükake tihendi otsad soone üla- ja alanurka.

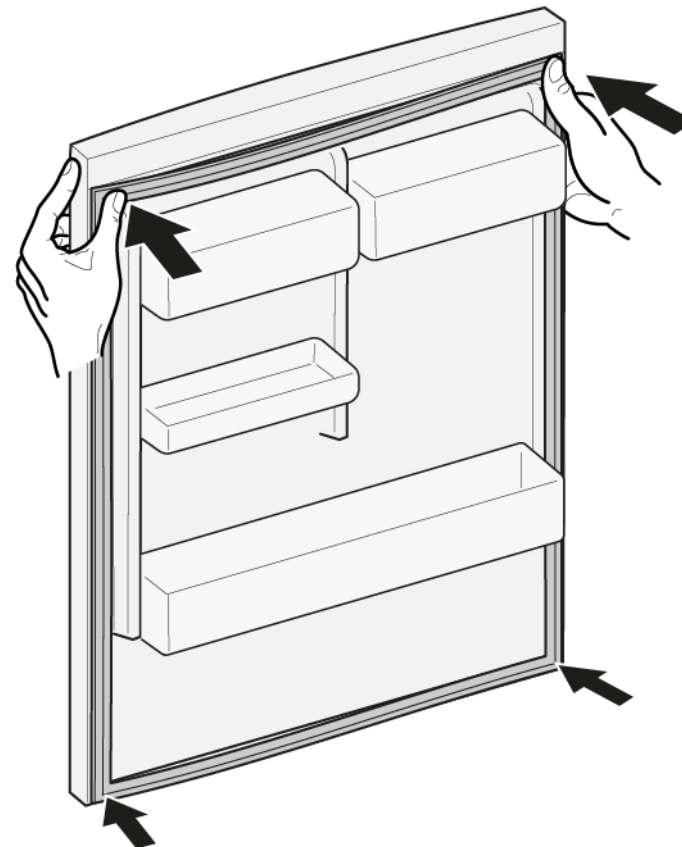

2.  Kui tihendi soon on kahjustatud,
- pöörduge klienditeeninduse poole.

3.  Uksetihendi kerge kõverdumine on normaalne ega mõjuta selle toimivust. Soovitav on uksetihend enne seadmesse paigaldamist sirgu tõmmata.

Soojendage uksetihendit fööni või sooja veega ja vormige seda käsitsi.

5. Vajutage terve tihend jupphaaval soonde.

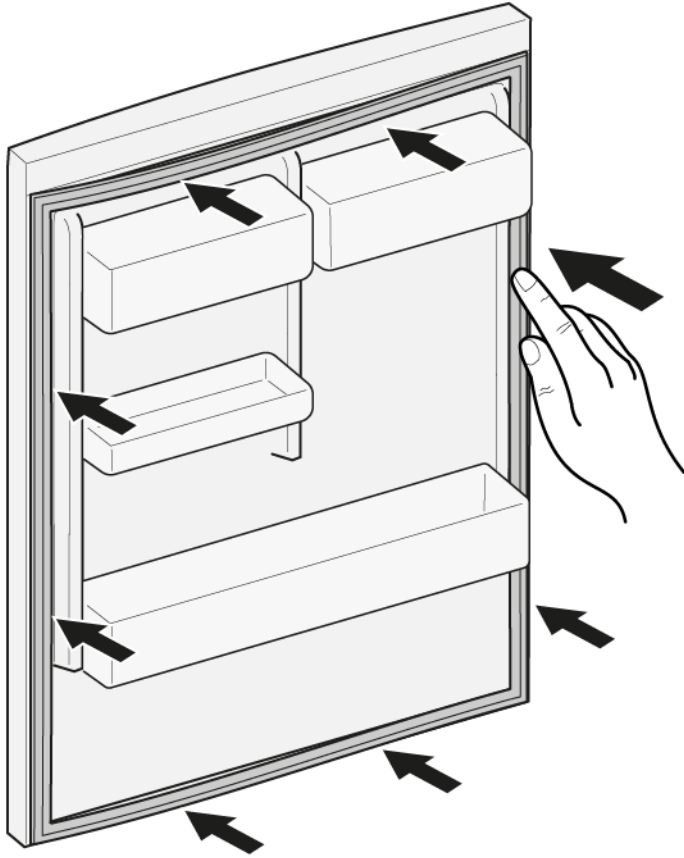

➡ Uksetihend on paigaldatud.

4.2 Käepideme vahetamine

Eritööriistad:

- ☞ Tähtsük TX20 6,3 mm (1/4 tolli) [00340865]
- ☞ Lapik kruvikeeraja Tera 10 mm × 1,6 mm × 200 mm

Nõue:

- ✔ Seade on toitest lahutatud.
- ✔ Uks on lahti.

4.2.1 Käepideme eemaldamine

- ▶ 1. Eemaldage kaks kruvikatet (1).
- ▶ 2. Keerake lahti kaks kruvi (2).
- ▶ 3. Eemaldage käepide (3).

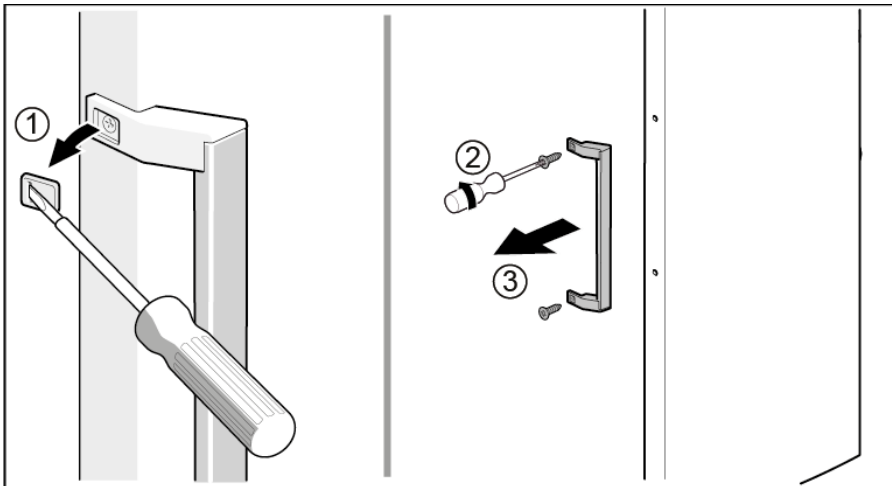

➡ Ukse käepide on eemaldatud.



Teise ukse käepidet saab eemaldada samamoodi.

4.2.2 Käepideme paigaldamine

- ▶ Paigaldage vastupidises järjekorras.

4.3 Ülemise uksehinge vahetamine

Eritööriistad:

Tähtotsik TX20

6,3 mm (1/4 tolli)

[00340865]

	<p style="text-align: center;">HOIATUS</p> <p>Masked, kogukad seadmed! Selja- ja lihasevigastused</p> <ul style="list-style-type: none"> ▶ Seadme ust tohivad eemaldada vaid vastava väljaõppe saanud spetsialistid. ▶ Seadme liigutamiseks on vaja kaht inimest. ▶ Kasutage vaid sobivaid tööriistu ja varustust.
	<p style="text-align: center;">ETTEVAATUST!</p> <p>Teravad servad! Lõikehaavad</p> <ul style="list-style-type: none"> ▶ Kandke kaitsekindaid.
	<p style="text-align: center;">HOIATUS</p> <p>Viltuses asendis seadmete libisemisoht! Luumurrud/muljumised</p> <ul style="list-style-type: none"> ▶ Kindlustage seadmed libisemise vastu.
	<p style="text-align: center;">ETTEVAATUST!</p> <p>Lahtikeeratud poltidest tingitud osade kukkumisoht! Kukkuvatest osadest tingitud vigastused.</p> <ul style="list-style-type: none"> ▶ Kinnitage osa allakukkumise vastu.
	<p style="text-align: center;">TÄHELEPANU!</p> <p>Lahtikeeratud poltidest tingitud osade kukkumisoht! Seadme teiste osade kahjustused või klientide vara kahjustused.</p> <ul style="list-style-type: none"> ▶ Kinnitage osa allakukkumise vastu.

Nõue:

- ✔ Seade on toitest lahutatud.
- ✔ Seadme sisearmatuur on eemaldatud.

4.3.1 Ülemise uksehinge eemaldamine

1. Pange seade tagaküljele.

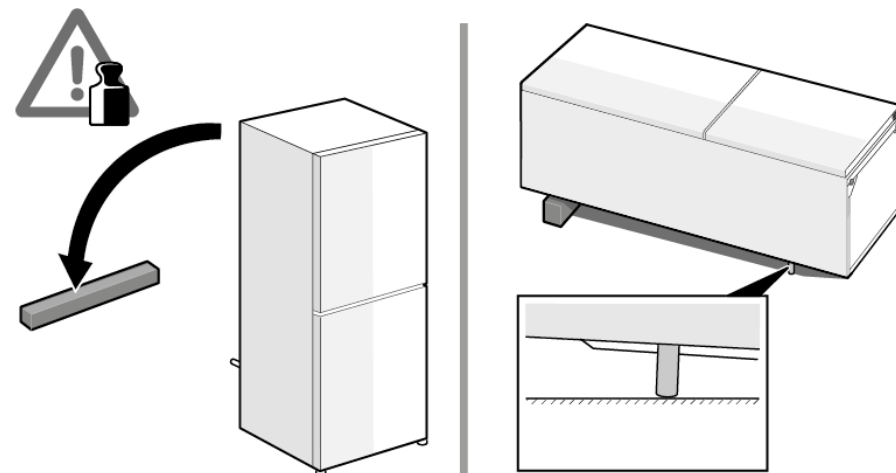

2. 1. Vajutage ülemise hinge katet mõlemal pool (1).
2. Nihutage ülemise hinge kate välja (2).
3. Pöörake hinge katet (3).
4. Eemaldage ülemise hinge kate (4).
5. Eemaldage kaks kruvi (5).
6. Eemaldage ülemine hing (6).

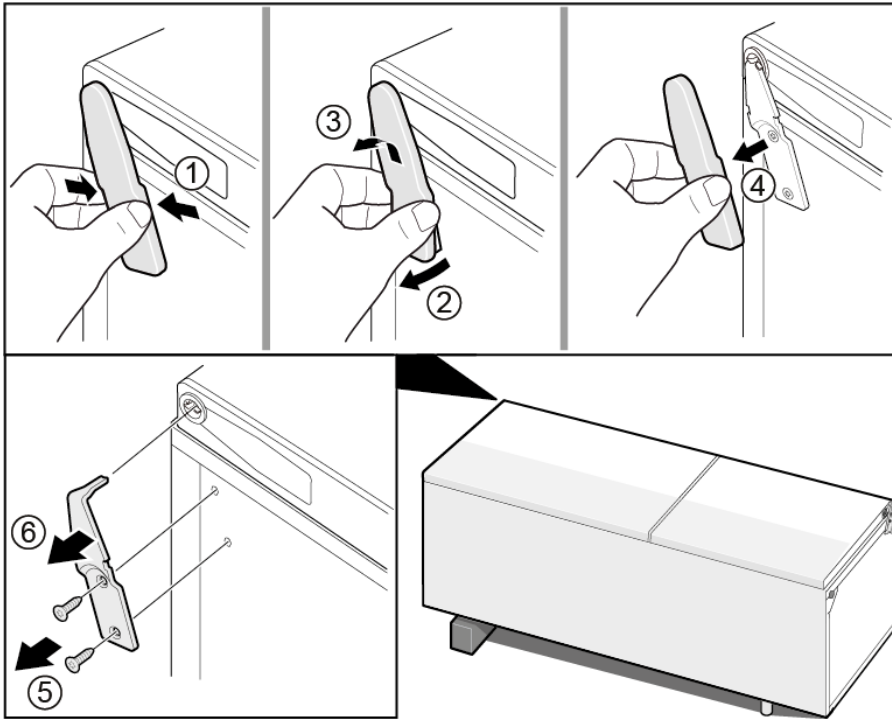

➔ Ülemine hing on eemaldatud.

4.3.2 Ülemise uksehinge paigaldamine

- ▶ Paigaldage vastupidises järjekorras.

4.4 Ülemise uksehingeme vahetamine (uks koos kuvaga)

Eritööriistad:

Tähtotsik TX20

6,3 mm (1/4 tolli)

[00340865]

	⚠ HOIATUS
	<p>Masked, kogukad seadmed! Selja- ja lihasevigastused</p> <ul style="list-style-type: none"> ▶ Seadme ust tohivad eemaldada vaid vastava väljaõppe saanud spetsialistid. ▶ Seadme liigutamiseks on vaja kaht inimest. ▶ Kasutage vaid sobivaid tööriistu ja varustust.

	⚠ ETTEVAATUST!
	<p>Teravad servad! Lõikehaavad</p> <ul style="list-style-type: none"> ▶ Kandke kaitsekindaid.

	⚠ HOIATUS
	<p>Viltuses asendis seadmete libisemisoht! Luumurrud/muljumised</p> <ul style="list-style-type: none"> ▶ Kindlustage seadmed libisemise vastu.

	⚠ ETTEVAATUST!
	<p>Lahtikeeratud poltidest tingitud osade kukkumisoht! Kukkuvatest osadest tingitud vigastused.</p> <ul style="list-style-type: none"> ▶ Kinnitage osa allakukkumise vastu.

	TÄHELEPANU!
	<p>Lahtikeeratud poltidest tingitud osade kukkumisoht! Seadme teiste osade kahjustused või klientide vara kahjustused.</p> <ul style="list-style-type: none"> ▶ Kinnitage osa allakukkumise vastu.

	⚠ OHT
	<p>Liikuvatest osadest tingitud elektrilöögi oht! Kui remonditööd on valesti tehtud, esineb elektrilöögist tingitud eluohu.</p> <ul style="list-style-type: none"> ▶ Elektrilisi osasid peavad parandama kvalifitseeritud elektrikud. ▶ Pärast remonti peab olema tehtud ohutuskatse vastavalt standardile VDE 0701 või riiklikele määrustele.

	⚠ OHT
	<p>Liikuvatest osadest tingitud elektrilöögi oht! Elektrilöögist tingitud surm</p> <ul style="list-style-type: none"> ▶ Enne remonditöödega alustamist ühendage seadmed elektrivõrgust lahti vähemalt 60 sekundit varem.

Nõue:

- ✓ Seade on toitest lahutatud.
- ✓ Seadme sisearmatuur on eemaldatud.

4.4.1 Ülemise uksehingeme eemaldamine

1. Pange seade tagaküljele.

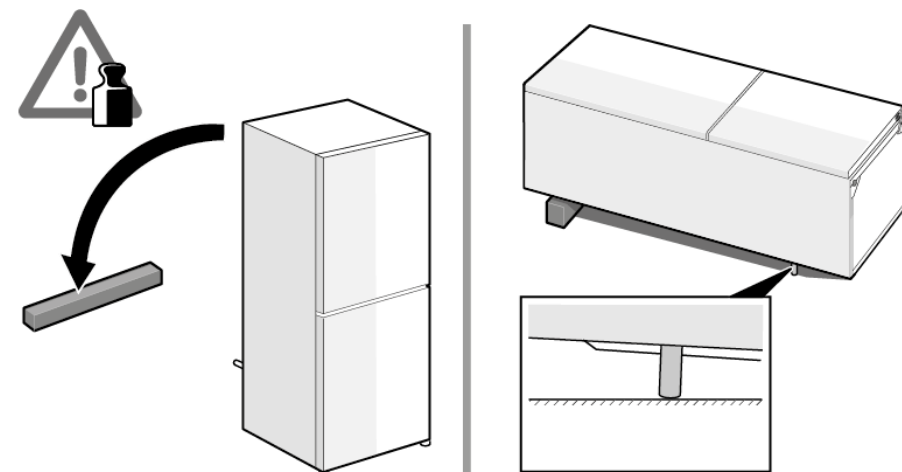

2. 1. Eemaldage ülemise hinge kate (1).
2. Eemaldage kaablikarbi kate (2).
3. Lahutage elektriühendus (3).
4. Keerake lahti maaühenduse kruvi (4).
5. Eemaldage kaablikaitse (5).
6. Keerake kruvi lahti (6).

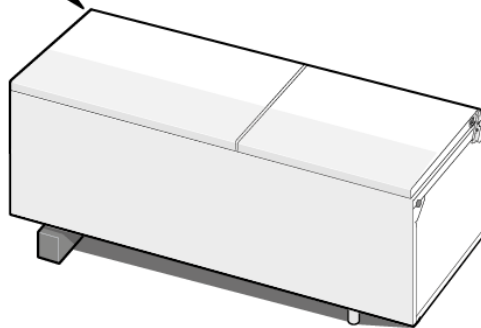
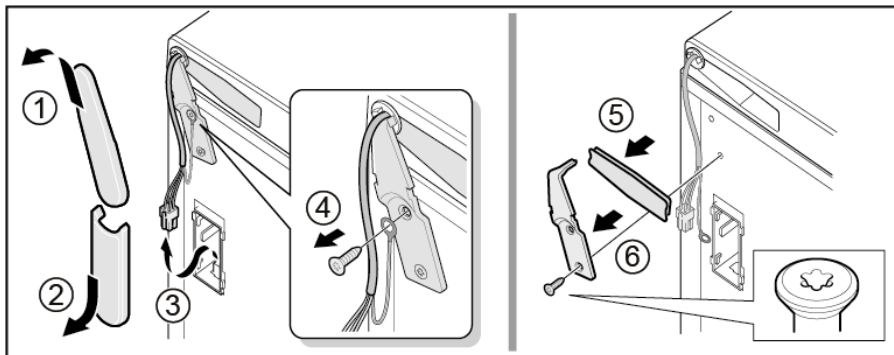

 Ülemine hing on eemaldatud.

4.4.2 Ülemise uksehinge paigaldamine

- ▶ Paigaldage vastupidises järjekorras.

4.5 Keskmise uksehinge vahetamine

Eritööriistad:

Tähtotsik TX20

6,3 mm (1/4 tolli)

[00340865]

	<p style="text-align: center;">⚠ HOIATUS</p> <p>Ranked, kogukad seadmed! Selja- ja lihasevigastused</p> <ul style="list-style-type: none"> ▶ Seadme ust tohivad eemaldada vaid vastava väljaõppe saanud spetsialistid. ▶ Seadme liigutamiseks on vaja kaht inimest. ▶ Kasutage vaid sobivaid tööriistu ja varustust.
	<p style="text-align: center;">⚠ ETTEVAATUST!</p> <p>Teravad servad! Lõikehaavad</p> <ul style="list-style-type: none"> ▶ Kandke kaitsekindaid.
	<p style="text-align: center;">⚠ HOIATUS</p> <p>Viltuses asendis seadmete libisemisoht! Luumurrud/muljumised</p> <ul style="list-style-type: none"> ▶ Kindlustage seadmed libisemise vastu.
	<p style="text-align: center;">⚠ ETTEVAATUST!</p> <p>Lahtikeeratud poltidest tingitud osade kukkumisoht! Kukkuvatest osadest tingitud vigastused.</p> <ul style="list-style-type: none"> ▶ Kinnitage osa allakukkumise vastu.
	<p style="text-align: center;">TÄHELEPANU!</p> <p>Lahtikeeratud poltidest tingitud osade kukkumisoht! Seadme teiste osade kahjustused või klientide vara kahjustused.</p> <ul style="list-style-type: none"> ▶ Kinnitage osa allakukkumise vastu.

Nõue:

- ✔ Seade on toitest lahutatud.
- ✔ Seadme sisearmatuur on eemaldatud.
- ✔ Ülemine uksehing on eemaldatud.

4.5.1 Keskmise uksehinge eemaldamine

- ▶ 1. Eemaldage külmikuosa uks (1).
- ▶ 2. Keerake lahti kaks kruvi (2).
- ▶ 3. Eemaldage keskmine hing (3).

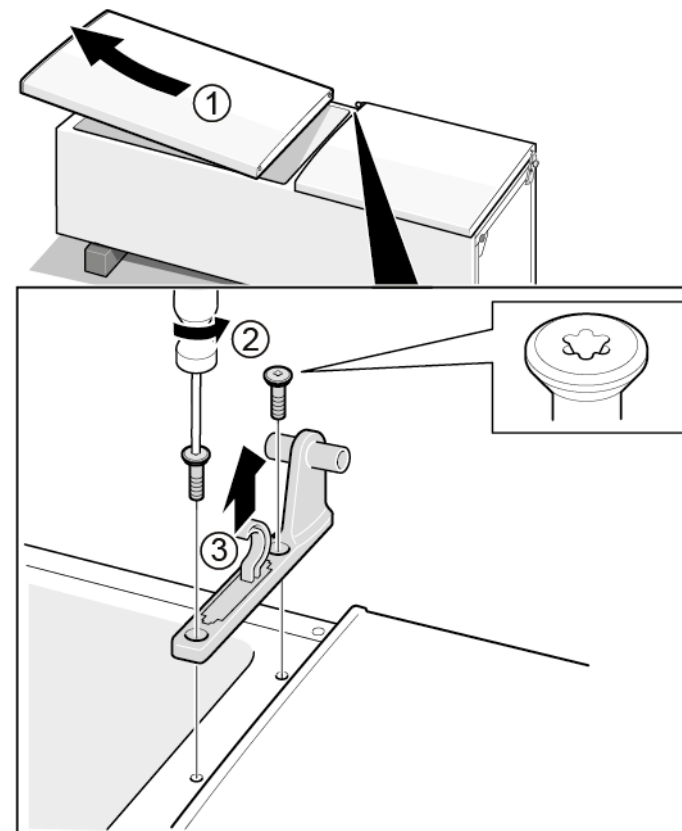

- ➡ Keskmine hing on eemaldatud.

4.5.2 Keskmise uksehinge paigaldamine

- ▶ Paigaldage vastupidises järjekorras.

4.6 Alumise uksehinge vahetamine

Eritööriistad:

Tähtotsik TX20

6,3 mm (1/4 tolli)

[00340865]

	<p style="text-align: center;">⚠ HOIATUS</p> <p>Masked, kogukad seadmed! Selja- ja lihasevigastused</p> <ul style="list-style-type: none"> ▶ Seadme ust tohivad eemaldada vaid vastava väljaõppe saanud spetsialistid. ▶ Seadme liigutamiseks on vaja kaht inimest. ▶ Kasutage vaid sobivaid tööriistu ja varustust.
	<p style="text-align: center;">⚠ ETTEVAATUST!</p> <p>Teravad servad! Lõikehaavad</p> <ul style="list-style-type: none"> ▶ Kandke kaitsekindaid.
	<p style="text-align: center;">⚠ HOIATUS</p> <p>Viltuses asendis seadmete libisemisoht! Luumurrud/muljumised</p> <ul style="list-style-type: none"> ▶ Kindlustage seadmed libisemise vastu.
	<p style="text-align: center;">⚠ ETTEVAATUST!</p> <p>Lahtikeeratud poltidest tingitud osade kukkumisoht! Kukkuvatest osadest tingitud vigastused.</p> <ul style="list-style-type: none"> ▶ Kinnitage osa allakukkumise vastu.
	<p style="text-align: center;">TÄHELEPANU!</p> <p>Lahtikeeratud poltidest tingitud osade kukkumisoht! Seadme teiste osade kahjustused või klientide vara kahjustused.</p> <ul style="list-style-type: none"> ▶ Kinnitage osa allakukkumise vastu.

Nõue:

- ✔ Seade on toitest lahutatud.
- ✔ Seadme sisearmatuur on eemaldatud.
- ✔ Ülemine hing on eemaldatud.
- ✔ Keskmine hing on eemaldatud.

4.6.1 Alumise uksehinge eemaldamine

- ▶ 1. Eemaldage sügavkülmikuosa uks (1).
- ▶ 2. Keerake kruvi lahti (2).
- ▶ 3. Keerake alumine hing välja (3).
- ▶ 4. Eemaldage alumine hing (4).

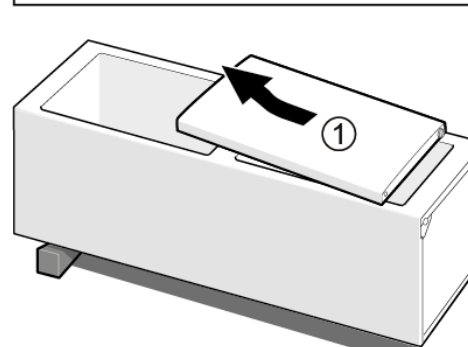
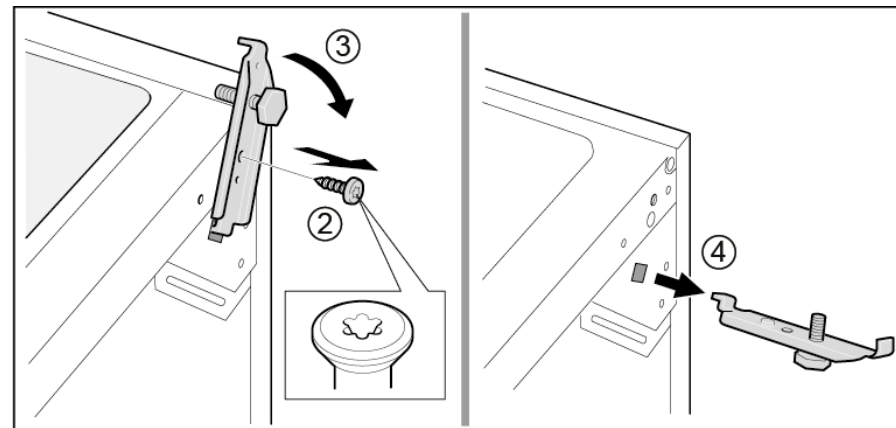

- ➡ Alumine uksehing on eemaldatud.

4.6.2 Alumise uksehinge paigaldamine

- ▶ Paigaldage vastupidises järjekorras.

4.7 Riiuli vahetamine

Nõue:

- ✔ Uks on lahti.

4.7.1 Riiuli eemaldamine

- ▶ Tõmmake riiul välja.

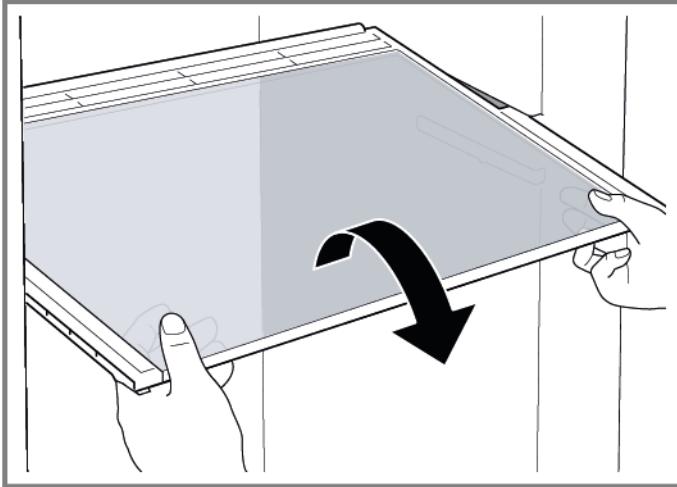

➡ Riiul on eemaldatud.

4.7.2 Riiuli paigaldamine

- ▶ Paigaldage vastupidises järjekorras.

4.8 Pudelialuse vahetamine

Nõue:

- ✓ Uks on lahti.

4.8.1 Pudelialuse eemaldamine

- ▶ Tõmmake pudelialus välja.

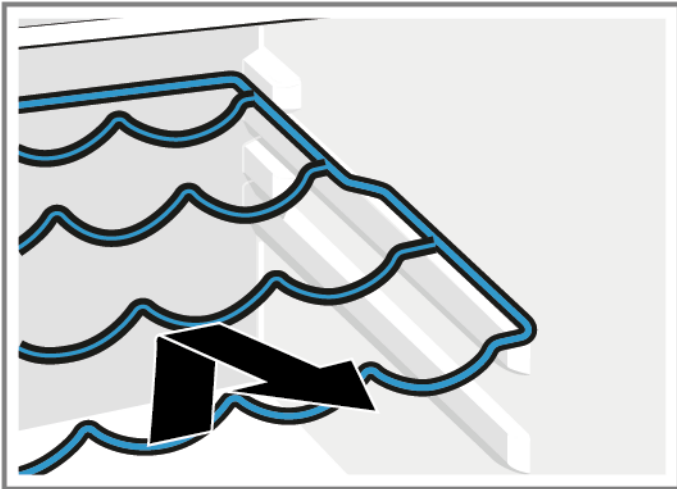

- ➡ Pudelialus on eemaldatud.

4.8.2 Pudelialuse paigaldamine

- ▶ Paigaldage vastupidises järjekorras.

4.9 Ukseraami vahetamine

Nõue:

- ✓ Uks on lahti.

4.9.1 Ukseraami eemaldamine

- ▶ Tõstke ukseraam üles.

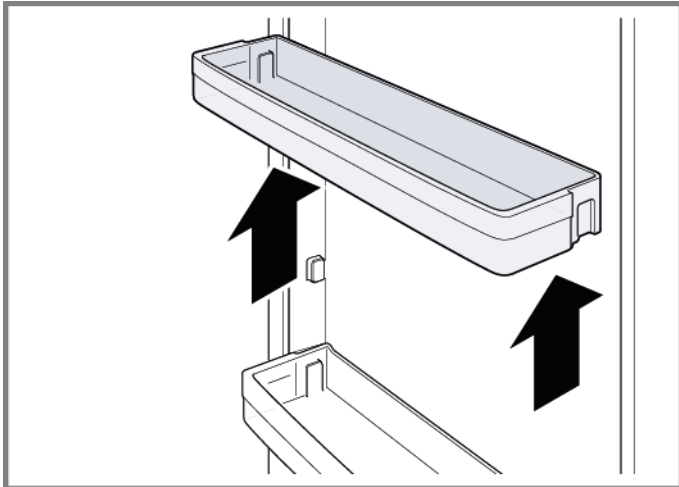

➡ Ukseraam on eemaldatud.

4.9.2 Ukseraami paigaldamine

- ▶ Paigaldage vastupidises järjekorras.

4.10 Reguleeritava ukseraami vahetamine

Nõue:

- ✓ Uks on lahti.

4.10.1 Reguleeritava ukseraami eemaldamine

- ▶ Liigutage reguleeritav ukseraam üles, kuni ukseraam hoidikust välja tuleb.

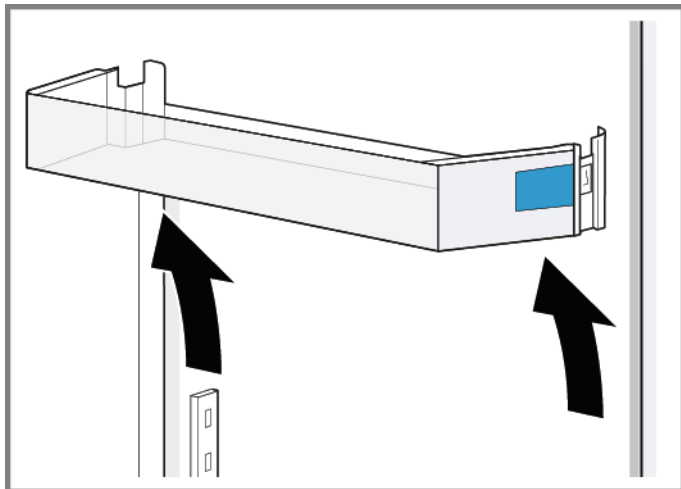

➡ Reguleeritav ukseraam on eemaldatud.

4.10.2 Reguleeritava ukseraami paigaldamine

- ▶ Paigaldage vastupidises järjekorras.

4.11 Külmutatud toidu mahuti vahetamine

Nõue:

- ✓ Uks on lahti.

4.11.1 Külmutatud toidu mahuti eemaldamine

- ▶ 1. Tõmmake külmutatud toidu mahuti täielikult välja (1).
- ▶ 2. Eemaldage toidumahuti (2).

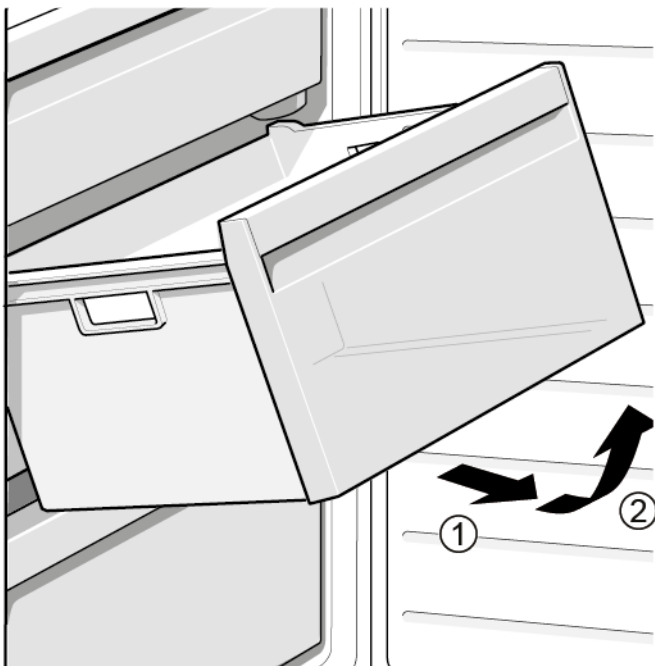

- ➡ Külmutatud toidu mahuti on eemaldatud.

4.11.2 Külmutatud toidu mahuti paigaldamine

- ▶ Paigaldage vastupidises järjekorras.

4.12 Mahuti vahetamine

Nõue:

- ✓ Uks on lahti.

4.12.1 Mahuti eemaldamine

- ▶ 1. Tõmmake alumine külmpapimahuti välja (1).
- ▶ 2. Tõmmake ülemine külmpapimahuti välja (2).

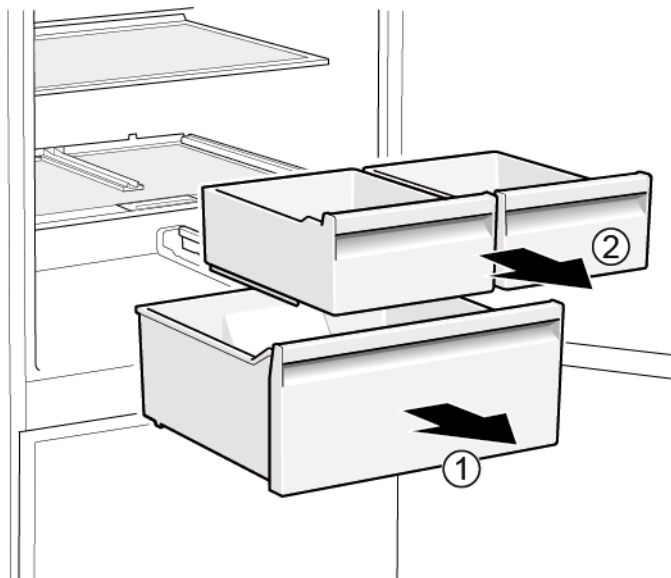

- ➡ Mahutid on eemaldatud.

4.12.2 Mahuti paigaldamine

- ▶ Paigaldage vastupidises järjekorras.

4.13 Laiendatava mahuti vahetamine

Nõue:

- ✓ Uks on lahti.

4.13.1 Laiendatava mahuti eemaldamine

- ▶ 1. Tõmmake laiendatav mahuti täielikult välja (1).
- ▶ 2. Eemaldage laiendatav mahuti (2).

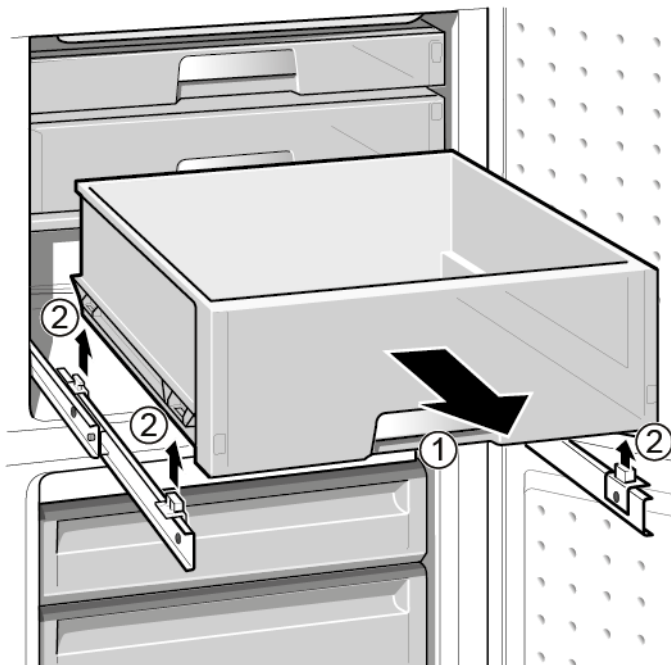

- ➡ Laiendatav mahuti on eemaldatud.

4.13.2 Laiendatava mahuti paigaldamine

- ▶ Paigaldage vastupidises järjekorras.

4.14 LED-kohtvalgusti vahetamine

Eritööriistad:

Eritööriist [00342180]

 Teie seadmel on LED-tuli, mis ei vaja hooldust. Seda tuld tohib parandada ainult klienditeenindus või volitatud tehnik!

 **OHT**
Liikuvatest osadest tingitud elektrilöögi oht!
Kui remonditööd on valesti tehtud, esineb elektrilöögist tingitud eluoht.
▶ Elektrilisi osasid peavad parandama kvalifitseeritud elektrikud.
▶ Pärast remonti peab olema tehtud ohutuskatse vastavalt standardile VDE 0701 või riiklikele määrustele.

 **OHT**
Liikuvatest osadest tingitud elektrilöögi oht!
Elektrilöögist tingitud surm
▶ Enne remonditöödega alustamist ühendage seadmed elektrivõrgust lahti vähemalt 60 sekundit varem.

 **ETTEVAATUST!**
Teravad servad!
Lõikehaavad
▶ Kandke kaitsekindaid.

Nõue:

- ✔ Seade on toitest lahutatud.
- ✔ Uks on lahti.

4.14.1 LED-kohtvalgusti eemaldamine

1. Kasutage LED-kohtvalgusti väljatõmbamiseks eritööriista (1).



2. Ühendage lahti LED-kohtvalgusti elektriühendused.
➡ LED-kohtvalgusti on eemaldatud.

4.14.2 LED-kohtvalgusti paigaldamine

- ▶ Paigaldage vastupidises järjekorras.

4.15 Ülemise LED-tule vahetamine

Eritööriistad:

- Lapik kruvikeeraja Tera 2,4 mm × 0,4 mm × 60 mm, komplektis [00341820]

i Teie seadmel on LED-tuli, mis ei vaja hooldust. Seda tuld tohib parandada ainult klienditeenindus või volitatud tehnik!

⚠ OHT
Liikuvatest osadest tingitud elektrilöögi oht!
 Kui remonditööd on valesti tehtud, esineb elektrilöögist tingitud eluoht.
 ▶ Elektrilisi osadid peavad parandama kvalifitseeritud elektrikud.
 ▶ Pärast remonti peab olema tehtud ohutuskatse vastavalt standardile VDE 0701 või riiklikele määrustele.

⚠ OHT
Liikuvatest osadest tingitud elektrilöögi oht!
 Elektrilöögist tingitud surm
 ▶ Enne remonditöödega alustamist ühendage seadmed elektrivõrgust lahti vähemalt 60 sekundit varem.

⚠ ETTEVAATUST!
Teravad servad!
 Lõikehaavad
 ▶ Kandke kaitsekindaid.

Nõue:

- ✓ Seade on toitest lahutatud.
- ✓ Uks on lahti.
- ✓ Ülemine sisearmatuur on eemaldatud.

4.15.1 LED-tule eemaldamine

- Liigutage LED-tuld vasakule.

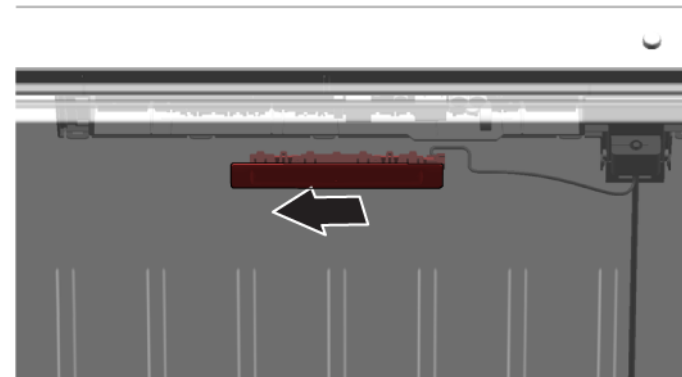

- ➡ LED-tule elektrühendus on lahutatud.

- Vabastage LED-tule haagid.

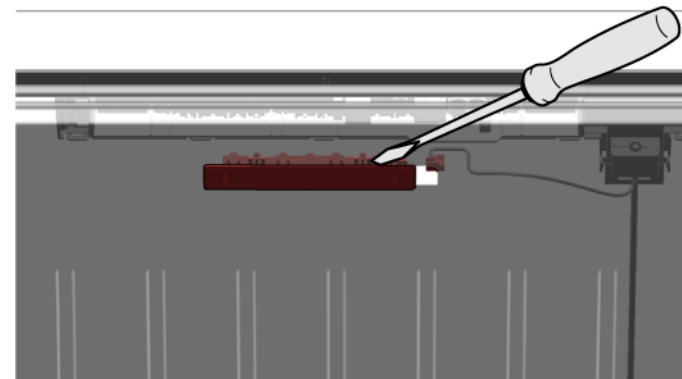

3. Eemaldage LED-tuli, liigutades seda ettepoole.

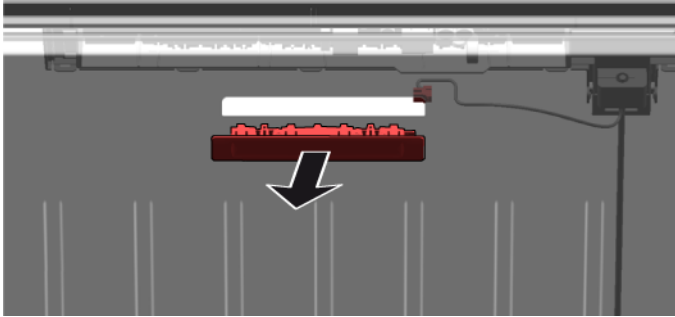

- ➡ LED-tuli on eemaldatud.

4.15.2 Ülemise LED-tule paigaldamine

- ▶ Paigaldage vastupidises järjekorras.

4.16 Külgmise LED-valgusriba vahetamine

Eritööriistad:

 Iminapp Ø50 mm [00342224]



 Teie seadmel on LED-tuli, mis ei vaja hooldust. Seda tuld tohib parandada ainult klienditeenindus või volitatud tehnik!

 **OHT**
Liikuvatest osadest tingitud elektrilöögi oht!
 Kui remonditööd on valesti tehtud, esineb elektrilöögist tingitud eluoht.
 ▶ Elektrilisi osasid peavad parandama kvalifitseeritud elektrikud.
 ▶ Pärast remonti peab olema tehtud ohutuskatse vastavalt standardile VDE 0701 või riiklikele määrustele.

 **OHT**
Liikuvatest osadest tingitud elektrilöögi oht!
 Elektrilöögist tingitud surm
 ▶ Enne remonditöödega alustamist ühendage seadmed elektrivõrgust lahti vähemalt 60 sekundit varem.

 **ETTEVAATUST!**
Teravad servad!
 Lõikehaavad
 ▶ Kandke kaitsekindaid.

Nõue:

-  Seade on toitest lahutatud.
-  Uks on lahti.
-  Külmuosa riiulid on eemaldatud.

4.16.1 Külgmise LED-valgusriba eemaldamine

1. Kleepige iminapp külgmise LED-valgusriba ülemise kolmandiku külge.



2. Tõmmake iminapp koos külgmise LED-valgusribaga ühe keerava liigutusega ettepoole.

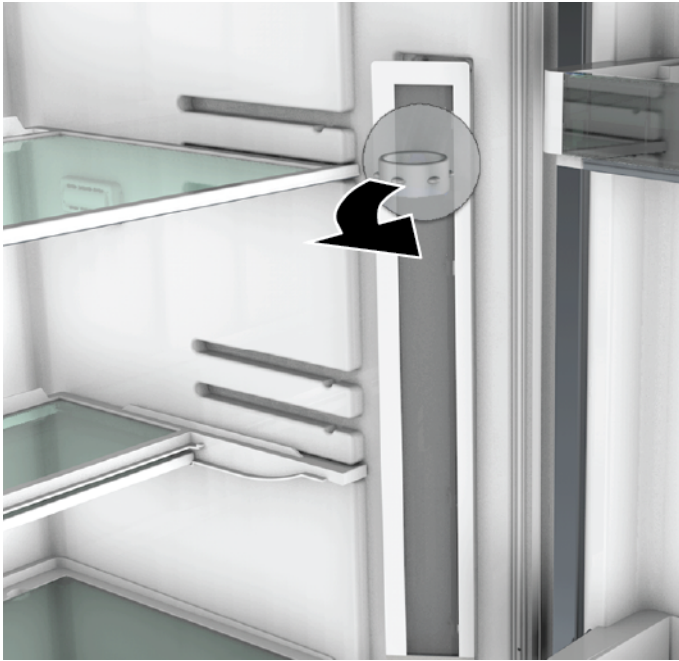



3. Lahutage külgmise LED-valgusriba elektriühendus.
➡ Külgmise LED-valgusriba on eemaldatud.

4.16.2 Külgmise LED-valgusriba paigaldamine

1. Ühendage külgmise LED-valgusriba elektriühendus.
 2. Kinnitage külgmise LED-valgusriba selle kohale külmkapi seinal (haagid lähevad klõpsuga paika).
- ➡ Külgmise LED-valgusriba on paigaldatud.

4.17 LED-kohtvalgusti vahetamine

Eritööriistad:

-  Eritööriist [00342180]
-  Lapik kruvikeeraja Tera 2,4 mm × 0,4 mm × 60 mm, komplektis [00341820]



 Teie seadmel on LED-tuli, mis ei vaja hooldust. Seda tuld tohib parandada ainult klienditeenindus või volitatud tehnik!

 **OHT**
Liikuvatest osadest tingitud elektrilöögi oht!
 Kui remonditööd on valesti tehtud, esineb elektrilöögist tingitud eluoht.
 ▶ Elektrilisi osasid peavad parandama kvalifitseeritud elektrikud.
 ▶ Pärast remonti peab olema tehtud ohutuskatse vastavalt standardile VDE 0701 või riiklikele määrustele.

 **OHT**
Liikuvatest osadest tingitud elektrilöögi oht!
 Elektrilöögist tingitud surm
 ▶ Enne remonditöödega alustamist ühendage seadmed elektrivõrgust lahti vähemalt 60 sekundit varem.

 **ETTEVAATUST!**
Teravad servad!
 Lõikehaavad
 ▶ Kandke kaitsekindaid.

Nõue:

-  Seade on toitest lahutatud.
-  Uks on lahti.
-  Külmiüksa riulid on eemaldatud.

4.17.1 LED-kohtvalgusti eemaldamine

1. Vabastage LED-kohtvalgusti kate.

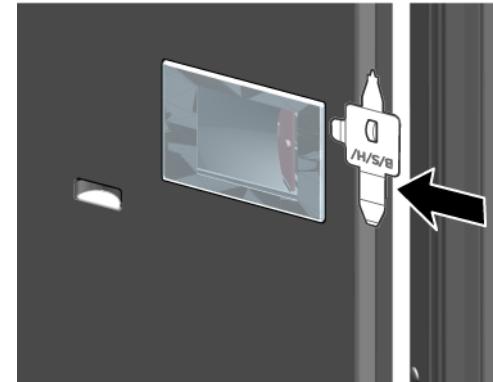

2. Tõmmake LED-kohtvalgusti katet sissepoole ja lükake seda samal ajal edasi.

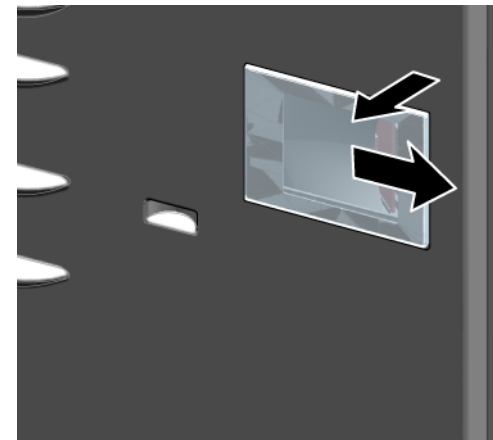

3. Eemaldage LED-kohtvalgusti moodul.

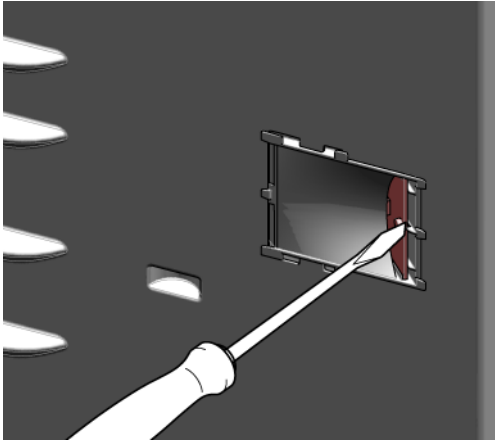

4. Lahutage LED-kohtvalgusti elektrühendus.

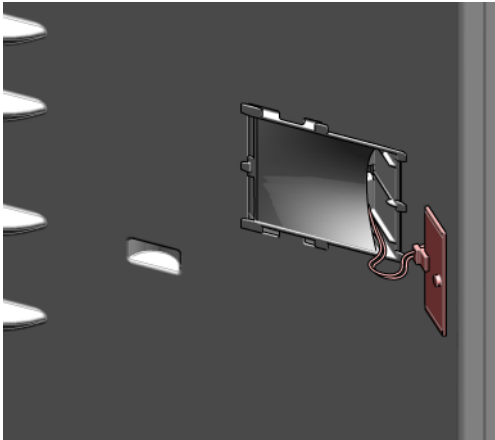





➡ LED-kohtvalgusti on eemaldatud.

4.17.2 LED-kohtvalgusti paigaldamine

- ▶ Paigaldage vastupidises järjekorras.

Korjausvinkit - Jääkaappipakastin

 Tämä asiakirja	206
1.1 Tärkeitä tietoja.....	206
1.1.1 Tarkoitus	206
1.2 Symboleiden merkitys.....	206
1.2.1 Vaaratasot.....	206
1.2.2 Varoitusmerkit.....	206
1.2.3 Varoitusten rakenne	207
1.2.4 Yleiset symbolit.....	207
 Turvallisuus	208
2.1 Yleiset turvallisuusohjeet.....	208
2.1.1 Kaikki kotitalouskoneet.....	208
 Työkalut ja apuvälineet	209
 Korjaus	210
4.1 Oven tiivisteen vaihtaminen.....	210
4.1.1 Oven tiivisteen poistaminen	210
4.1.2 Oven tiivisteen asennus	210
4.2 Ovenkahvan vaihtaminen.....	213
4.2.1 Ovenkahvan poistaminen	213
4.2.2 Ovenkahvan asennus.....	213
4.3 Oven yläsaranan vaihtaminen	214
4.3.1 Oven yläsaranan poistaminen.....	214
4.3.2 Oven yläsaranan asennus	215
4.4 Oven yläsaranan vaihtaminen (näytöllä varustettu ovi).....	216
4.4.1 Oven yläsaranan poistaminen.....	216
4.4.2 Oven yläsaranan asennus	217
4.5 Oven keskisaranan vaihtaminen.....	218
4.5.1 Oven keskisaranan poistaminen	218
4.5.2 Oven keskisaranan asennus.....	218
4.6 Oven alasaranan vaihtaminen	219
4.6.1 Oven alasaranan poistaminen.....	219
4.6.2 Oven alasaranan asennus.....	219
4.7 Hyllyn vaihtaminen	220
4.7.1 Hyllyn poistaminen	220
4.7.2 Hyllyn asennus	220

4.8 Pullohyllyn vaihtaminen	221
4.8.1 Pullohyllyn poistaminen	221
4.8.2 Pullohyllyn asennus	221
4.9 Ovihyllyn vaihtaminen	222
4.9.1 Ovihyllyn poistaminen	222
4.9.2 Ovihyllyn asennus	222
4.10 Säädettävän ovihyllyn vaihtaminen	223
4.10.1 Säädettävän ovihyllyn poistaminen	223
4.10.2 Säädettävän ovihyllyn asennus	223
4.11 Pakastelokeron vaihtaminen	224
4.11.1 Pakastelokeron poistaminen	224
4.11.2 Pakastelokeron asennus.....	224
4.12 Lokeron vaihtaminen	225
4.12.1 Lokeron poistaminen	225
4.12.2 Lokeron asennus.....	225
4.13 Ulosvedettävän lokeron vaihtaminen	226
4.13.1 Ulosvedettävän lokeron poistaminen	226
4.13.2 Ulosvedettävän lokeron asennus.....	226
4.14 LED-kohdevalon vaihtaminen	227
4.14.1 LED-kohdevalon poistaminen.....	227
4.14.2 LED-kohdevalon asennus	227
4.15 LED-ylävalon vaihtaminen	228
4.15.1 LED-valon poistaminen	228
4.15.2 LED-ylävalon asennus	229
4.16 LED-sivupalkkivalon vaihtaminen	230
4.16.1 LED-sivupalkkivalon poistaminen	230
4.16.2 LED-sivupalkkivalon asennus.....	231
4.17 LED-kohdevalon vaihtaminen	232
4.17.1 LED-kohdevalon poistaminen.....	232
4.17.2 LED-kohdevalon asennus	233

Tämä asiakirja

1.1 Tärkeitä tietoja

1.1.1 Tarkoitus

Näiden korjausohjeiden tarkoituksena on auttaa kuluttajaa korjaamaan laitteita itse ekologista suunnittelua koskevan asetuksen (päivitys 03/2021) mukaisesti.



Ne sisältävät tietoja siitä, miten määrätyt varaosat voidaan vaihtaa. Lisäksi niihin sisältyy tietoja varoituksista ja riskeistä.

Ota yhteyttä huoltopalveluun, jos sinulla on kysyttävää. Vastamme vahingoista vain, jos korjausohjeita on noudatettu oikein.

1.2 Symboleiden merkitys

1.2.1 Vaaratasot

Varoitustasot koostuvat symbolista ja huomiosanasta. Huomiosanat ilmoittava vaaran vakavuuden.

Varoitustaso	Merkitys
 VAARA	Varoituksen laiminlyönti johtaa kuolemaan tai vakaviin loukkaantumisiin.
 VAROITUS	Varoituksen laiminlyönti voi johtaa kuolemaan tai vakaviin loukkaantumisiin.
 HUOMAA	Varoituksen laiminlyönti voi johtaa lieviin loukkaantumisiin.
HUOMIO!	Varoituksen laiminlyönti voi johtaa omaisuusvahinkoihin.

Taulukko 1: Vaaratasot

1.2.2 Varoitusmerkit

Varoitusmerkit ovat symboleita sisältäviä esityksiä, jotka osoittavat vaaran tyyppin.

Tässä asiakirjassa käytetään seuraavia varoitusmerkkejä:

Varoitusmerkki	Merkitys
	Yleinen varoitus
	Sähköjännitteestä aiheutuva vaara
	Räjähdysvaara
	Viiltohaavojen vaara
	Murskautumisen vaara

Tämä asiakirja

Varoitusmerkki	Merkitys
	Kuumista pinnoista aiheutuva vaara
	Voimakkaasta magneettikentästä aiheutuva vaara
	Ionisoimattomasta säteilystä aiheutuva vaara



Taulukko 2: Varoitusmerkit

1.2.3 Varoitusten rakenne

Tämän asiakirjan sisältämällä varoituksilla on standardoitu ulkonäkö ja rakenne.



	<div style="background-color: red; color: white; padding: 2px; text-align: center;"> VAARA</div> <p>Vaaran tyyppi ja lähde! Vaaran/varoituksen laiminlyönnistä mahdollisesti aiheutuvat seuraukset.</p> <ul style="list-style-type: none">▶ Vaaran ehkäisemiseen liittyvät toimenpiteet ja kiellot.
--	--

Seuraavassa esimerkissä näytetään varoitus, joka varoittaa jännitteisten osien aiheuttamasta sähköiskusta. Vaaran välttämiseksi suoritettava toimenpide mainitaan.

	<div style="background-color: red; color: white; padding: 2px; text-align: center;"> VAARA</div> <p>Jännitteisten osien aiheuttama sähköiskun vaara! Sähköiskun aiheuttama kuolema</p> <ul style="list-style-type: none">▶ Erotta laitteet sähkövirrasta vähintään 60 sekuntia ennen korjaustöiden aloittamista.
---	---

1.2.4 Yleiset symbolit

Tässä asiakirjassa käytetään seuraavia yleisiä symboleja:

Yl. symboli	Merkitys
	Erikoisohjeen tunniste (teksti ja/tai kaavio)
	Yksinkertaisen ohjeen tunniste (vain teksti)

Yl. symboli	Merkitys
	Video-opetusohjelmaan johtavan linkin tunniste
	Tarvittavien työkalujen tunniste
	Tarvittavien edellytysten tunniste
	Ehdon (jos ..., sitten ...) tunniste
	Tuloksen tunniste
	Näppäimen tai painikkeen tunniste
	Materiaalinumeron tunniste
	Näytetyn tekstin/ikkunan (laitteen näytössä) tunniste

Taulukko 3: Yleiset symbolit

2.1 Yleiset turvallisuusohjeet

2.1.1 Kaikki kotitalouskoneet

Jännitteisten osien aiheuttama sähköiskun vaara!

- Virheet sähkökomponentteja sisältävissä korjauksissa voivat johtaa sähköiskuun!
- Kytke kone irti verkkovirrasta vähintään 60 sekuntia ennen töiden aloittamista.
- Pyydä korjauksen jälkeen suorittamaan VDE 0701 -säädöksen tai maakohtaisten säädösten mukainen turvallisuustesti.

Terävistä reunoista aiheutuva loukkaantumisvaara!

- Käytä suojakäsineitä.

Painavista ja liikkuvista komponenteista aiheutuva murskautumisen riski korjauksen, kunnossapidon, vianetsinnän ja huollon aikana

- Käytä suojakenkiä.
- Estä painavien komponenttien putoaminen.
- Älä koske liikkuviin komponentteihin.





Laitteen turvallisuudelle/toiminnalle aiheutuva riski!

- Käytä vain alkuperäisiä varaosia.

Staattiselle sähkölle herkkien komponenttien (ESDS) vaurioitumisen riski!

- Älä koske moduuleihin, liitännät ja johdinreitit mukaan luettuna.

Työkalut ja apuvälineet

Nimitys	Yksityiskohdat	Kuvat
Suojapeite [00342013]	60 cm x 50 cm	
Uraruuvimeisseli	Terä 2,4 mm x 0,4 mm x 60 mm, pakkauksessa [00341820]	
Erikoistyökalu [00342180]		
Imukuppi [00342224]	Ø50 mm	
Torx-kärki TX20 [00340865]	6,3 mm (1/4")	
Uraruuvimeisseli	Terä 10 mm x 1,6 mm x 200 mm	

4.1 Oven tiiviste vaihtaminen

Vaatus:

- ✓ Ovi on auki.

4.1.1 Oven tiiviste poistaminen

1. Irrota oven tiiviste urasta oikeassa ja vasemmassa nurkassa.

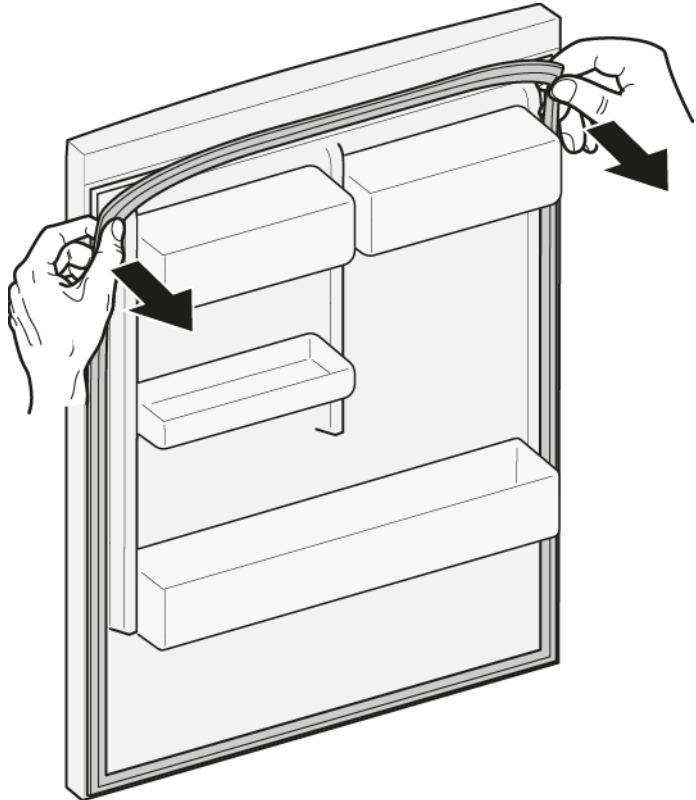

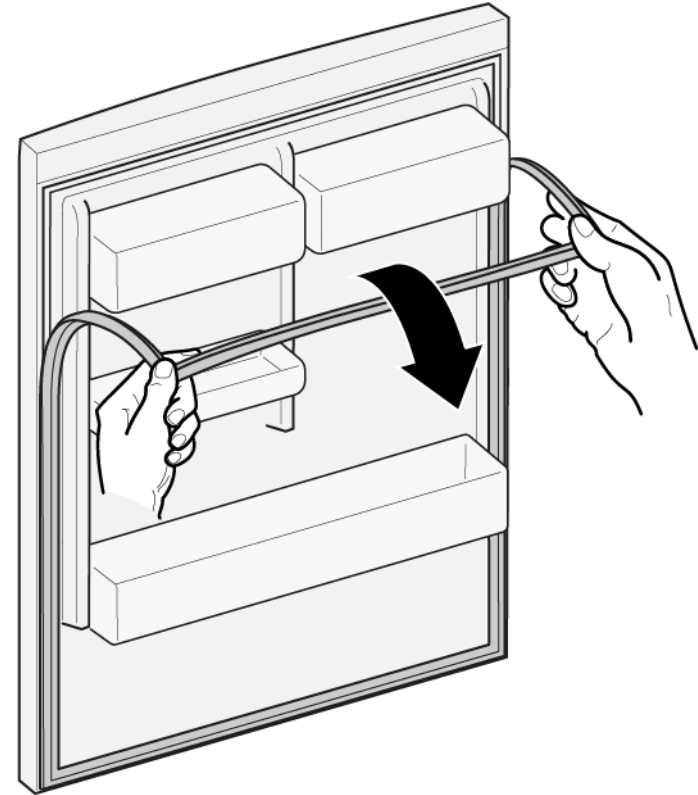

2. Vedä oven tiiviste ulos urasta.



- ➡ Oven tiiviste on poistettu.

4.1.2 Oven tiiviste asennus

	Uuden tiiviste paksuus voi poiketa hieman vanhan tiiviste paksuudesta. Sillä ei ole vaikutusta oven sulkeutumiseen eikä pitkän aikavälin toimintaan.
	Jos laitteessa on säädettävät saranat tai saranan kiinnittimet, voit optimoida sulkeutumista myöhemmin.
	Oven tiiviste sivuilla olevat pienet reiät ovat toiminnollisia (tarvitaan ilmanvaihtoa varten). Ne eivät ole tuotantovirheitä.

1. Tarkista, että tiivistettä varten oleva ura ei ole vioittunut.

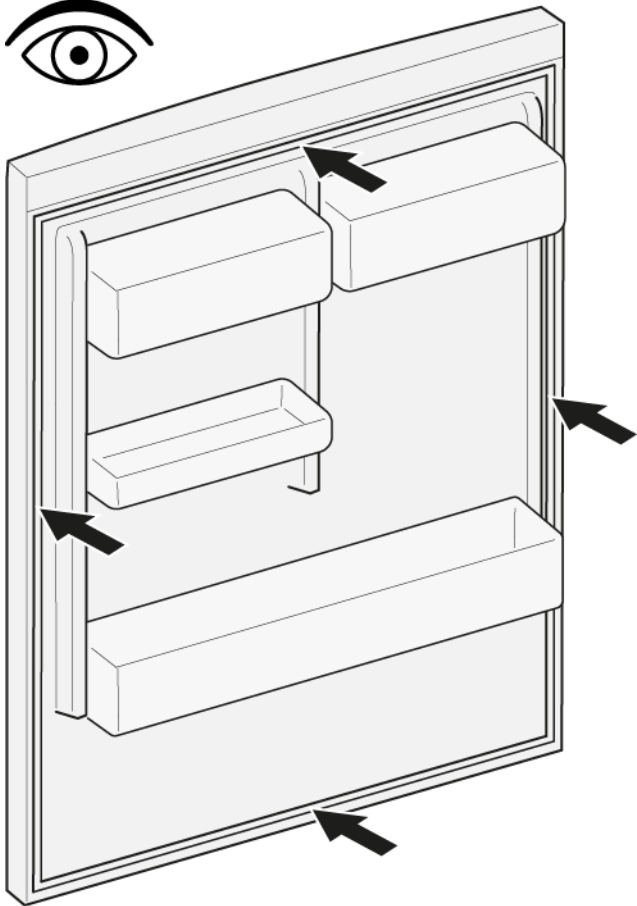

4. Työnnä tiivisteiden nurkat ylhäällä ja alhaalla uraan.

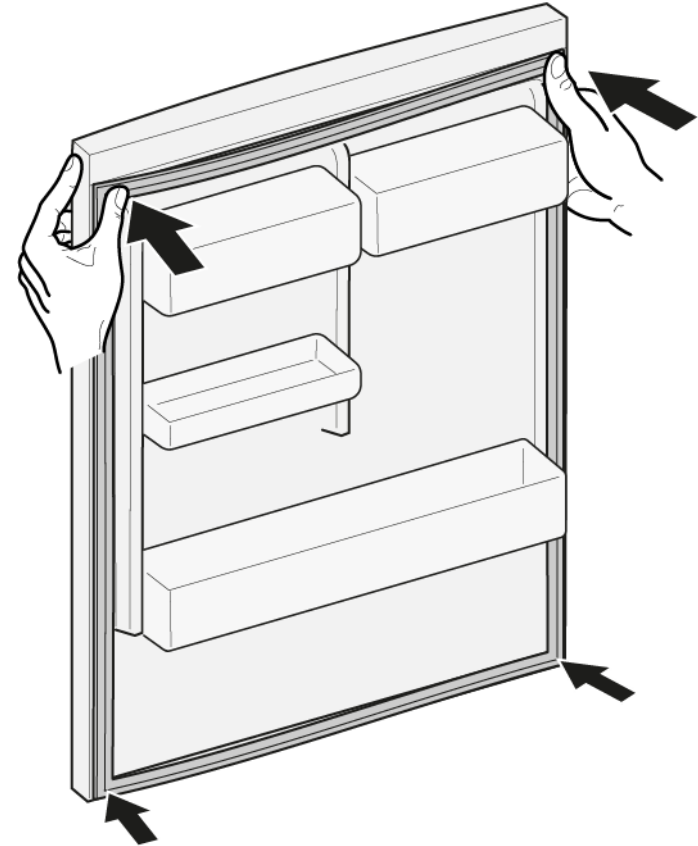

2.  Jos tiivisteiden ura on vioittunut.
- Ota yhteyttä asiakaspalveluun.

3.  Oven tiivisteiden pienet vääntymät ovat normaaleja eikä niillä ole vaikutusta sen toimintaan. Oven tiiviste kannattaa suoristaa, ennen kuin se asetetaan laitteeseen.

Kuumenna oven tiivistettä hiustenkuivaajalle tai kuumalla vedellä ja muotoile se käsin uudelleen.

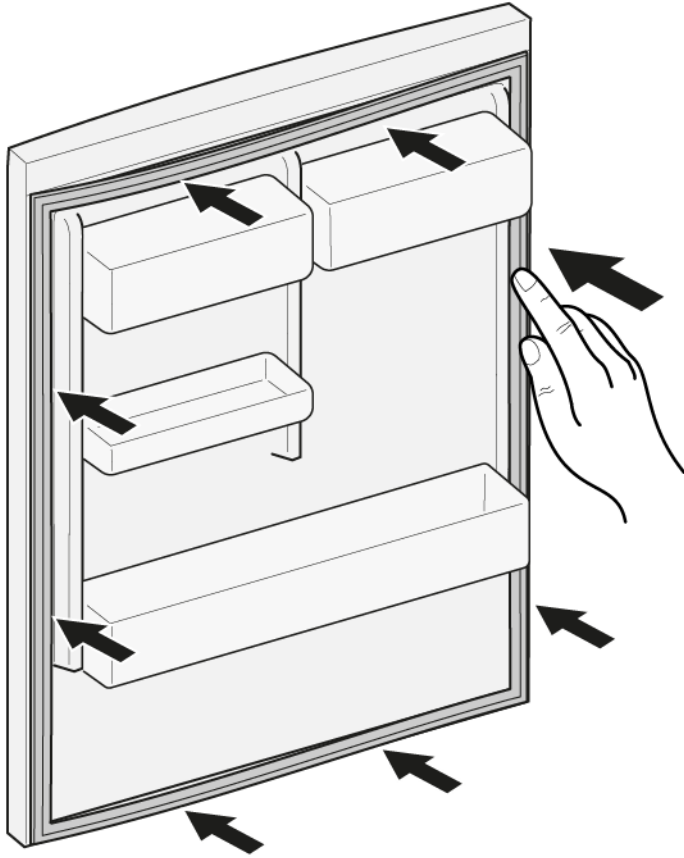

5. Paina koko tiiviste vähitellen uraan.





 Oven tiiviste on asennettu.

4.2 Ovenkahvan vaihtaminen

Erikoistyökalut:

-  Torx-kärki TX20 6,3 mm (1/4") [00340865]
-  Uraruuvimeisseli Terä 10 mm x 1,6 mm x 200 mm

Vaatus:

-  Kone on erotettu teholahteesta.
-  Ovi on auki.

4.2.1 Ovenkahvan poistaminen

- ▶ 1. Poista kaksi ruuvia suojusta (1).
- ▶ 2. Kierrä kaksi ruuvia auki (2).
- ▶ 3. Poista ovenkahva (3).

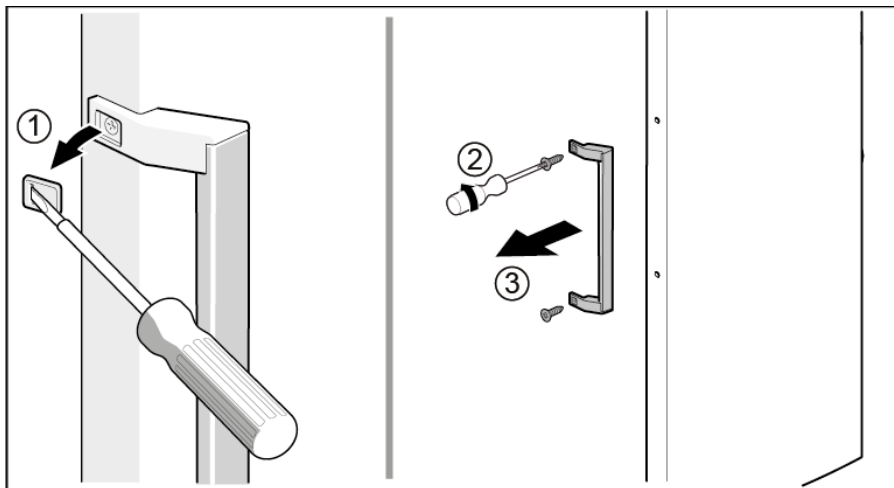

 Ovenkahva on poistettu.



Toisen oven ovenkahva voidaan poistaa samalla tavalla.

4.2.2 Ovenkahvan asennus

- ▶ Asenna vastakkaisessa järjestyksessä.





4.3 Oven yläsaranan vaihtaminen

Erikoistyökalut:

Torx-kärki TX20

6,3 mm (1/4")

[00340865]

	<p style="text-align: center;">VAROITUS</p> <p>Painavat, isokokoiset laitteet! Selän ja lihasten vammat</p> <ul style="list-style-type: none"> ▶ Vain koulutettujen ammattilaisten tulisi suorittaa laitteen oven poistamiseen liittyvät vaiheet. ▶ Laitteen siirtämiseen tarvitaan kahta ihmistä. ▶ Käytä vain soveltuvia työkaluja ja välineitä.
	<p style="text-align: center;">HUOMAA</p> <p>Terävät reunat! Viiltovammat</p> <ul style="list-style-type: none"> ▶ Käytä suojakäsineitä.
	<p style="text-align: center;">VAROITUS</p> <p>Kallistetun koneen luiskahtaminen.! Luunmurtumat/murskavammat</p> <ul style="list-style-type: none"> ▶ Estä koneiden luiskahtaminen.
	<p style="text-align: center;">HUOMAA</p> <p>Ruuvien avaamisesta aiheutuva osien putoamisen riski! Loukkaantuminen putoavien osien vuoksi.</p> <ul style="list-style-type: none"> ▶ Estä komponentin putoaminen.
	<p style="text-align: center;">HUOMIO!</p> <p>Ruuvien avaamisesta aiheutuva osien putoamisen riski! Vauriot koneen muille osille tai asiakkaan kodille, esim. lattia.</p> <ul style="list-style-type: none"> ▶ Estä komponentin putoaminen.

Vaatus:

- ✓ Kone on erotettu teholähteestä.
- ✓ Laitteen sisällä olevat lisävarusteet on poistettu.

4.3.1 Oven yläsaranan poistaminen

1. Aseta laite selälleen.

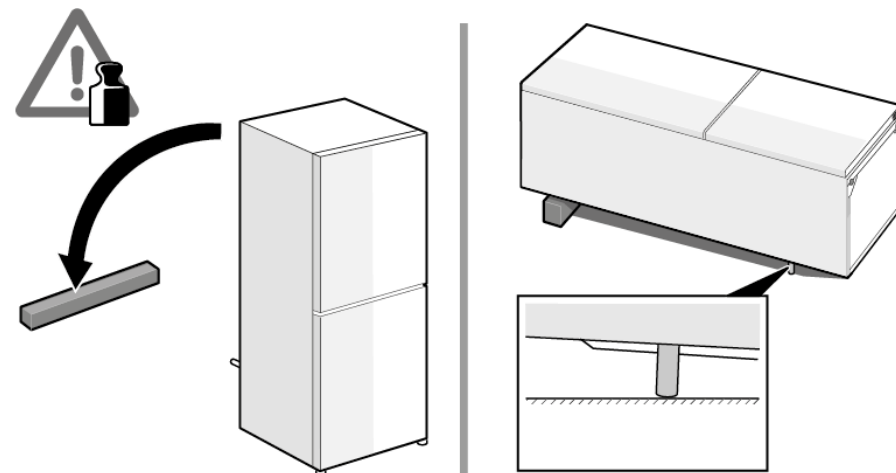

1. Paina yläsaranan suojusta kummallakin puolella (1).
2. Ota yläsaranan suojus ulos (2).
3. Pyöritä saranan suojusta (3).
4. Poista yläsaranan suojus (4).
5. Kierrä kaksi ruuvia auki (5).
6. Poista yläsarana (6).

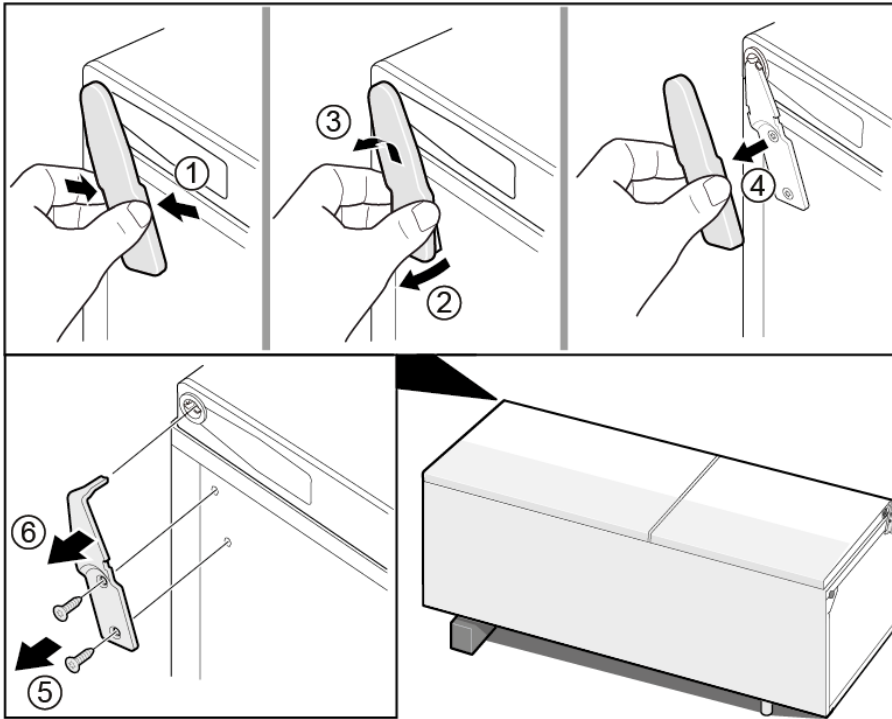

 Yläsarana on poistettu.

4.3.2 Oven yläsaranan asennus

- ▶ Asenna vastakkaisessa järjestyksessä.

4.4 Oven yläsaranan vaihtaminen (näytöllä varustettu ovi)

Erikoistyökalut:

Torx-kärki TX20 6,3 mm (1/4") [00340865]

	VAROITUS
Painavat, isokokoiset laitteet!	
Selän ja lihasten vammat	
<ul style="list-style-type: none"> ▶ Vain koulutettujen ammattilaisten tulisi suorittaa laitteen oven poistamiseen liittyvät vaiheet. ▶ Laitteen siirtämiseen tarvitaan kahta ihmistä. ▶ Käytä vain soveltuvia työkaluja ja välineitä. 	

	HUOMAA
Terävät reunat!	
Viiltovammat	
<ul style="list-style-type: none"> ▶ Käytä suojakäsineitä. 	

	VAROITUS
Kallistetun koneen luiskahtaminen.!	
Luunmurtumat/murskavammat	
<ul style="list-style-type: none"> ▶ Estä koneiden luiskahtaminen. 	

	HUOMAA
Ruuvien avaamisesta aiheutuva osien putoamisen riski!	
Loukkaantuminen putoavien osien vuoksi.	
<ul style="list-style-type: none"> ▶ Estä komponentin putoaminen. 	

	HUOMIO!
Ruuvien avaamisesta aiheutuva osien putoamisen riski!	
Vauriot koneen muille osille tai asiakkaan kodille, esim. lattia.	
<ul style="list-style-type: none"> ▶ Estä komponentin putoaminen. 	

	VAARA
Jännitteisten osien aiheuttama sähköiskun vaara!	
Sähköiskusta aiheutuva hengenvaara väärän korjauksen tapauksessa	
<ul style="list-style-type: none"> ▶ Sähköosien korjaus tulisi antaa pätevien sähköasentajien suoritettavaksi. ▶ Pyydä korjauksen jälkeen suorittamaan VDE 0701 -säädöksen tai maakohtaisten säädösten mukainen turvallisuustesti. 	

	VAARA
Jännitteisten osien aiheuttama sähköiskun vaara!	
Sähköiskun aiheuttama kuolema	
<ul style="list-style-type: none"> ▶ Erota laitteet sähkövirrasta vähintään 60 sekuntia ennen korjaustöiden aloittamista. 	

Vaatus:

- ✓ Kone on erotettu tehollisesta.
- ✓ Laitteen sisällä olevat lisävarusteet on poistettu.

4.4.1 Oven yläsaranan poistaminen

1. Aseta laite selälleen.

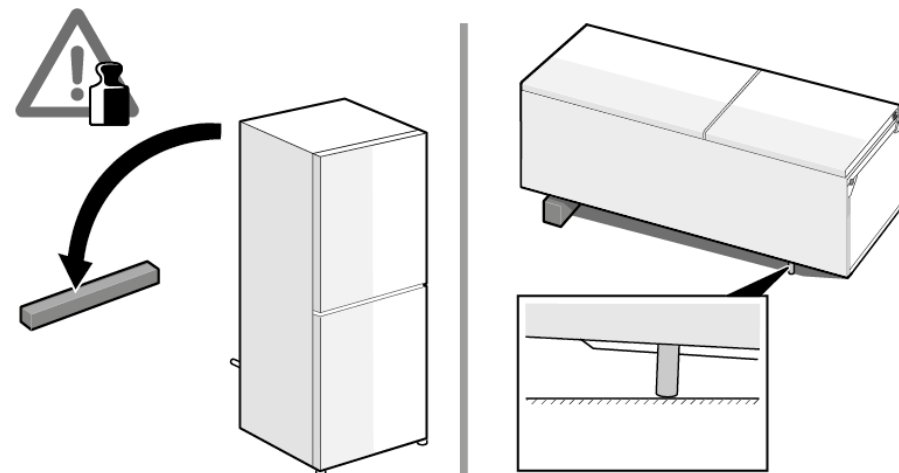

2. 1. Poista yläsaranan suojuus (1).
2. Poista kaapelirasian suojuus (2).
3. Irrota sähköliitäntä (3).
4. Kierrä maadoitusliitännän ruuvi auki (4).
5. Poista kaapelisuojaus (5).
6. Kierrä ruuvi auki (6).

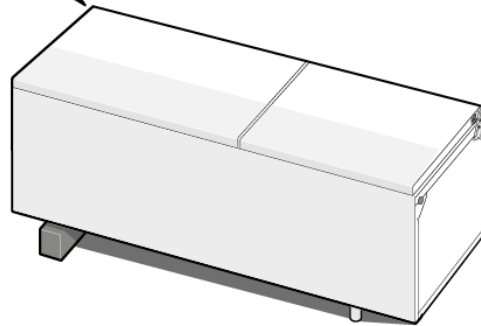
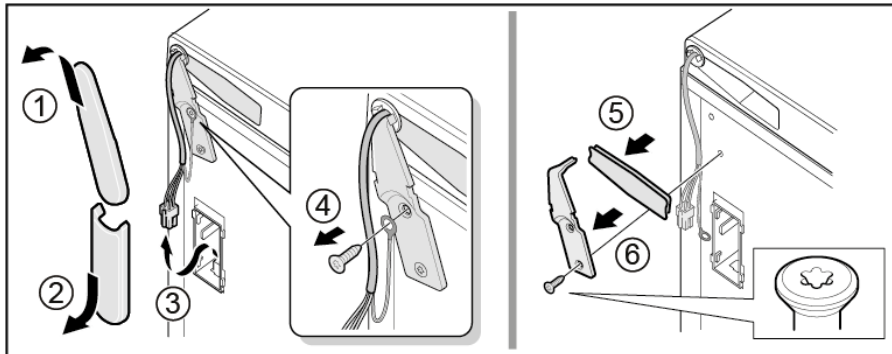

 Yläsarana on poistettu.

4.4.2 Oven yläsaranan asennus

- ▶ Asenna vastakkaisessa järjestyksessä.

4.5 Oven keskisaranan vaihtaminen

Erikoistyökalut:

Torx-kärki TX20 6,3 mm (1/4") [00340865]

	VAROITUS
Painavat, isokokoiset laitteet!	
Selän ja lihasten vammat	
<ul style="list-style-type: none"> ▶ Vain koulutettujen ammattilaisten tulisi suorittaa laitteen oven poistamiseen liittyvät vaiheet. ▶ Laitteen siirtämiseen tarvitaan kahta ihmistä. ▶ Käytä vain soveltuvia työkaluja ja välineitä. 	

	HUOMAA
Terävät reunat!	
Viiltovammat	
<ul style="list-style-type: none"> ▶ Käytä suojakäsineitä. 	

	VAROITUS
Kallistetun koneen luiskahtaminen.!	
Luunmurtumat/murskavammat	
<ul style="list-style-type: none"> ▶ Estä koneiden luiskahtaminen. 	

	HUOMAA
Ruuvien avaamisesta aiheutuva osien putoamisen riski!	
Loukkaantuminen putoavien osien vuoksi.	
<ul style="list-style-type: none"> ▶ Estä komponentin putoaminen. 	

	HUOMIO!
Ruuvien avaamisesta aiheutuva osien putoamisen riski!	
Vauriot koneen muille osille tai asiakkaan kodille, esim. lattia.	
<ul style="list-style-type: none"> ▶ Estä komponentin putoaminen. 	

Vaatus:

- ✔ Kone on erotettu teholähteestä.
- ✔ Laitteen sisällä olevat lisävarusteet on poistettu.
- ✔ Oven yläsarana on poistettu.

4.5.1 Oven keskisaranan poistaminen

- ▶ 1. Pois jääkaappiosan ovi (1).
- ▶ 2. Kierrä kaksi ruuvia auki (2).
- ▶ 3. Poista keskisarana (3).

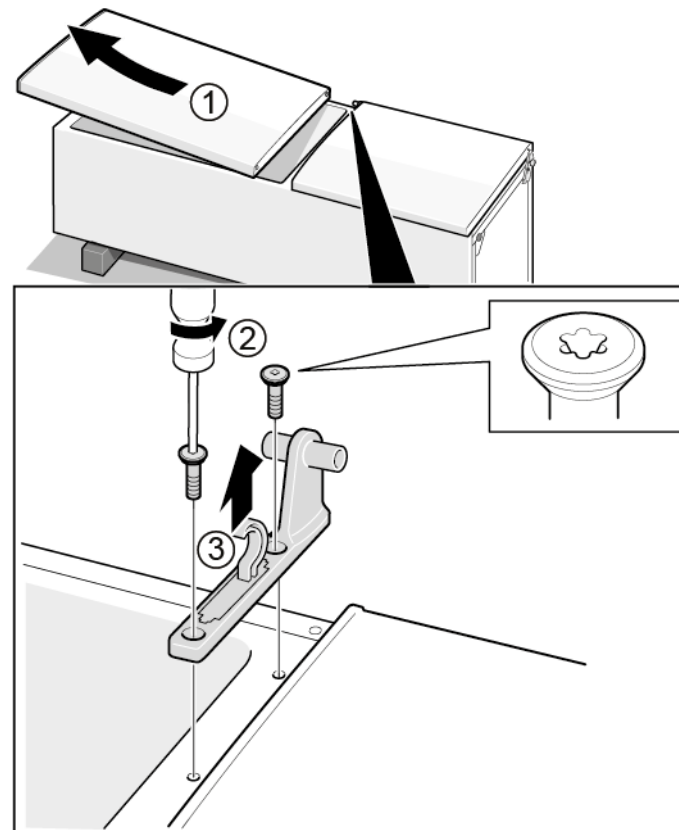

➡ Keskisarana on poistettu.

4.5.2 Oven keskisaranan asennus

- ▶ Asenna vastakkaisessa järjestyksessä.





4.6 Oven alasaranan vaihtaminen

Erikoistyökalut:

Torx-kärki TX20

6,3 mm (1/4")

[00340865]

	<p>VAROITUS</p> <p>Painavat, isokokoiset laitteet! Selän ja lihasten vammat</p> <ul style="list-style-type: none"> ▶ Vain koulutettujen ammattilaisten tulisi suorittaa laitteen oven poistamiseen liittyvät vaiheet. ▶ Laitteen siirtämiseen tarvitaan kahta ihmistä. ▶ Käytä vain soveltuvia työkaluja ja välineitä.
	<p>HUOMAA</p> <p>Terävät reunat! Viiltovammat</p> <ul style="list-style-type: none"> ▶ Käytä suojakäsineitä.
	<p>VAROITUS</p> <p>Kallistetun koneen luiskahtaminen! Luunmurtumat/murskavammat</p> <ul style="list-style-type: none"> ▶ Estä koneiden luiskahtaminen.
	<p>HUOMAA</p> <p>Ruuvien avaamisesta aiheutuva osien putoamisen riski! Loukkaantuminen putoavien osien vuoksi.</p> <ul style="list-style-type: none"> ▶ Estä komponentin putoaminen.
	<p>HUOMIO!</p> <p>Ruuvien avaamisesta aiheutuva osien putoamisen riski! Vauriot koneen muille osille tai asiakkaan kodille, esim. lattia.</p> <ul style="list-style-type: none"> ▶ Estä komponentin putoaminen.

Vaatus:

- ✓ Kone on erotettu teholähteestä.
- ✓ Laitteen sisällä olevat lisävarusteet on poistettu.
- ✓ Yläsarana on poistettu.
- ✓ Keskisarana on poistettu.

4.6.1 Oven alasaranan poistaminen

- ▶ 1. Poista pakastinosan ovi (1).
- ▶ 2. Kierrä ruuvi auki (2).
- ▶ 3. Kierrä alasarana ulos (3).
- ▶ 4. Poista alasarana (4).

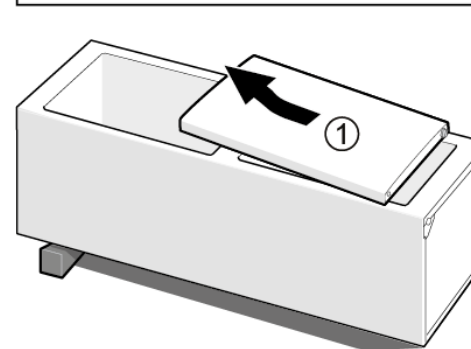
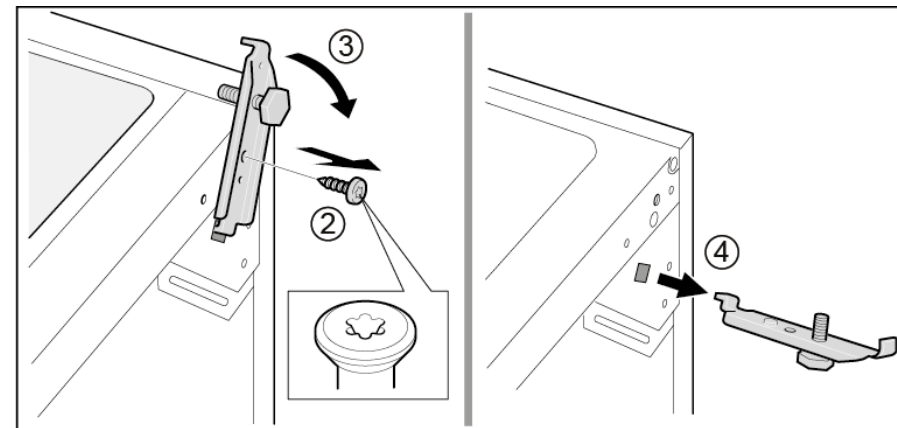

- ➡ Oven alasarana on poistettu.

4.6.2 Oven alasaranan asennus

- ▶ Asenna vastakkaisessa järjestyksessä.

4.7 Hyllyn vaihtaminen

Vaatus:

- ✔ Ovi on auki.

4.7.1 Hyllyn poistaminen

- ▶ Vedä hylly ulos.



- ➡ Hylly on poistettu.

4.7.2 Hyllyn asennus

- ▶ Asenna vastakkaisessa järjestyksessä.

4.8 Pullohyllyn vaihtaminen

Vaatus:

- ✔ Ovi on auki.

4.8.1 Pullohyllyn poistaminen

- ▶ Vedä pullohylly ulos.

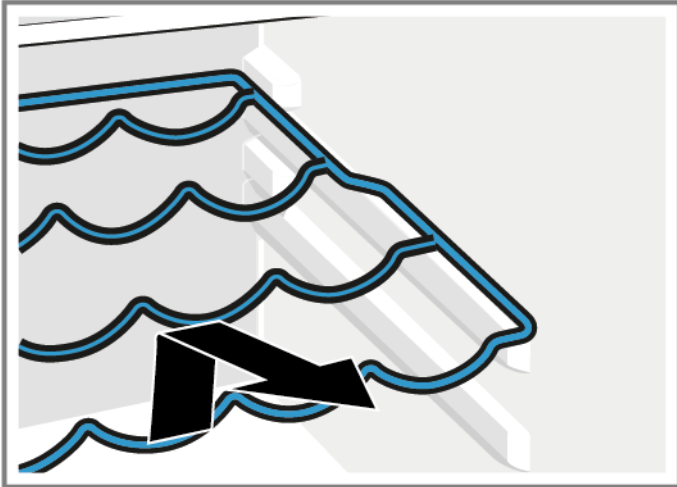

- ➡ Pullohylly on poistettu.

4.8.2 Pullohyllyn asennus

- ▶ Asenna vastakkaisessa järjestyksessä.

4.9 Ovihyllyn vaihtaminen

Vaatus:

- ✔ Ovi on auki.

4.9.1 Ovihyllyn poistaminen

- ▶ Nosta ovihylly pois yläsuuntaan.

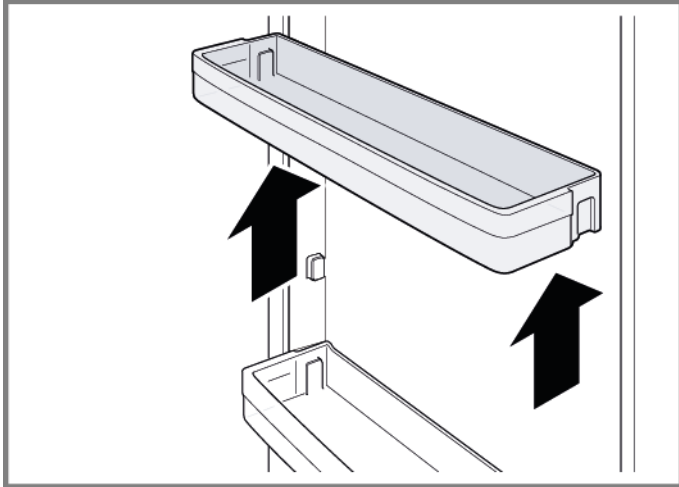

- ➡ Ovihylly on poistettu.

4.9.2 Ovihyllyn asennus

- ▶ Asenna vastakkaisessa järjestyksessä.

4.10 Säädettävän ovihyllyn vaihtaminen

Vaatus:

- ✔ Ovi on auki.

4.10.1 Säädettävän ovihyllyn poistaminen

- ▶ Siirrä korkeussäädettävää ovihyllyä yläsuuntaan, kunnes ovihylly irtoaa pidikkeestä.

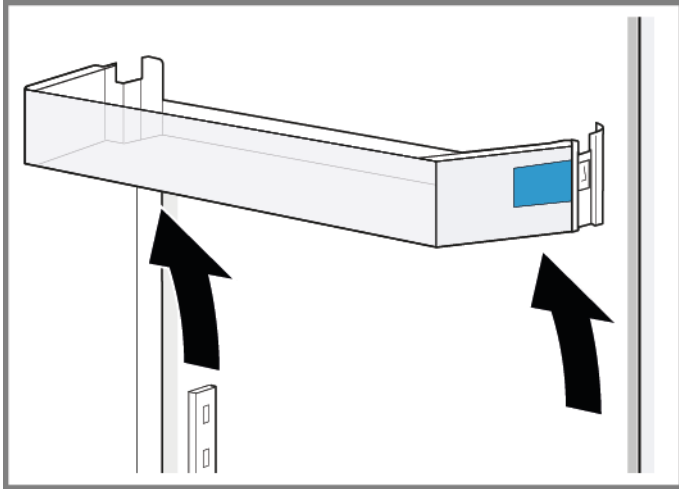

- ➡ Säädettävä ovihylly on poistettu.

4.10.2 Säädettävän ovihyllyn asennus

- ▶ Asenna vastakkaisessa järjestyksessä.

4.11 Pakastelokeron vaihtaminen

Vaatus:

- ✔ Ovi on auki.

4.11.1 Pakastelokeron poistaminen

- ▶ 1. Vedä pakastelokero kokonaan ulos (1).
- ▶ 2. Poista lokero (2).

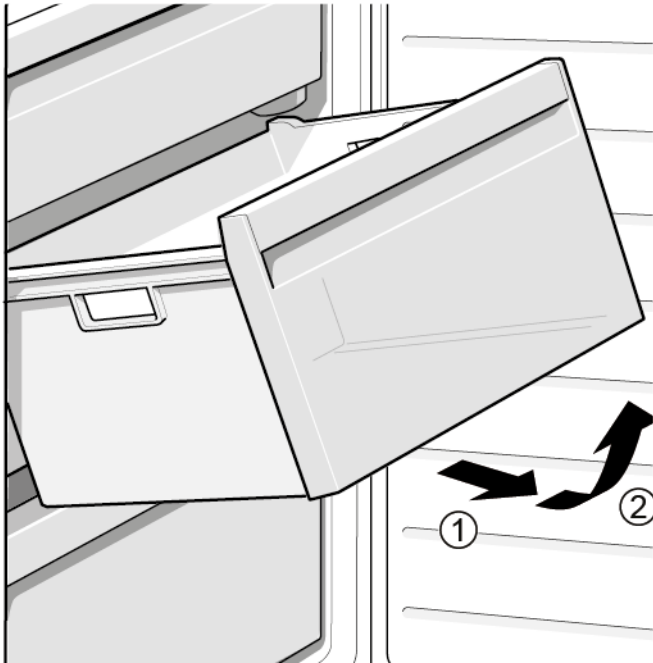

- ➡ Pakastelokero on poistettu.

4.11.2 Pakastelokeron asennus

- ▶ Asenna vastakkaisessa järjestyksessä.

4.12 Lokeron vaihtaminen

Vaatus:

- ✔ Ovi on auki.

4.12.1 Lokeron poistaminen

- ▶ 1. Ota alempi jääkaapin lokero ulos (1).
- ▶ 2. Ota ylempi jääkaapin lokero ulos (2).

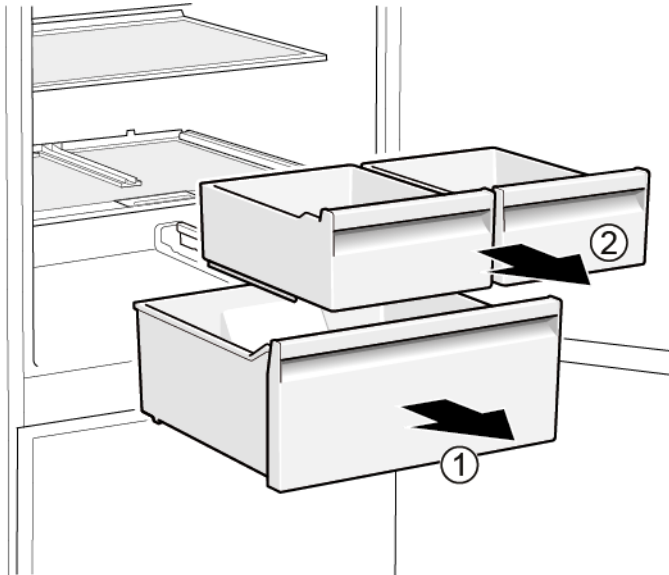

- ➡ Lokerot on poistettu.

4.12.2 Lokeron asennus

- ▶ Asenna vastakkaisessa järjestyksessä.

4.13 Ulosvedettävän lokeron vaihtaminen

Vaatus:

- ✔ Ovi on auki.

4.13.1 Ulosvedettävän lokeron poistaminen

- ▶ 1. Vedä ulosvedettävä lokero kokonaan ulos (1).
- ▶ 2. Poista ulosvedettävä lokero (2).

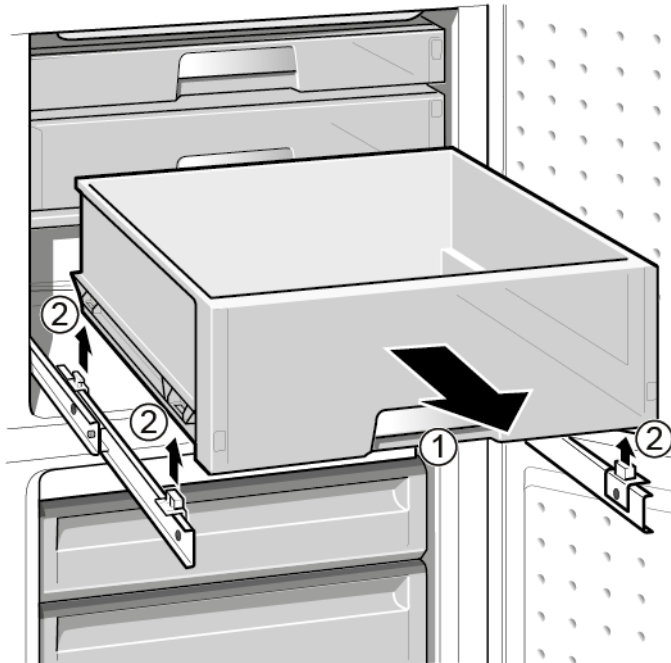

- ➡ Ulosvedettävä lokero on poistettu.

4.13.2 Ulosvedettävän lokeron asennus

- ▶ Asenna vastakkaisessa järjestyksessä.

4.14 LED-kohdevalon vaihtaminen

Erikoistyökalut:

Erikoistyökalu [00342180]

i Laite on varustettu huoltovapaalla LED-valolla. Vain huoltopalvelu tai valtuutetut teknikot saavat korjata nämä valot!

VAARA
Jännitteisten osien aiheuttama sähköiskun vaara!
 Sähköiskusta aiheutuva hengenvaara väärän korjauksen tapauksessa

- ▶ Sähköosien korjaus tulisi antaa pätevien sähköasentajien suoritettavaksi.
- ▶ Pyydä korjauksen jälkeen suorittamaan VDE 0701 -säädöksen tai maakohtaisten säädösten mukainen turvallisuustesti.

VAARA
Jännitteisten osien aiheuttama sähköiskun vaara!
 Sähköiskun aiheuttama kuolema

- ▶ Erotta laitteet sähkövirrasta vähintään 60 sekuntia ennen korjaustöiden aloittamista.

HUOMAA
Terävät reunat!
 Viiltovammat

- ▶ Käytä suojakäsineitä.

Vaatus:

- ✔ Kone on erotettu teholahteesta.
- ✔ Ovi on auki.

4.14.1 LED-kohdevalon poistaminen

1. Vedä LED-kohdevalo ulos erikoistyökalua käyttämällä (1).

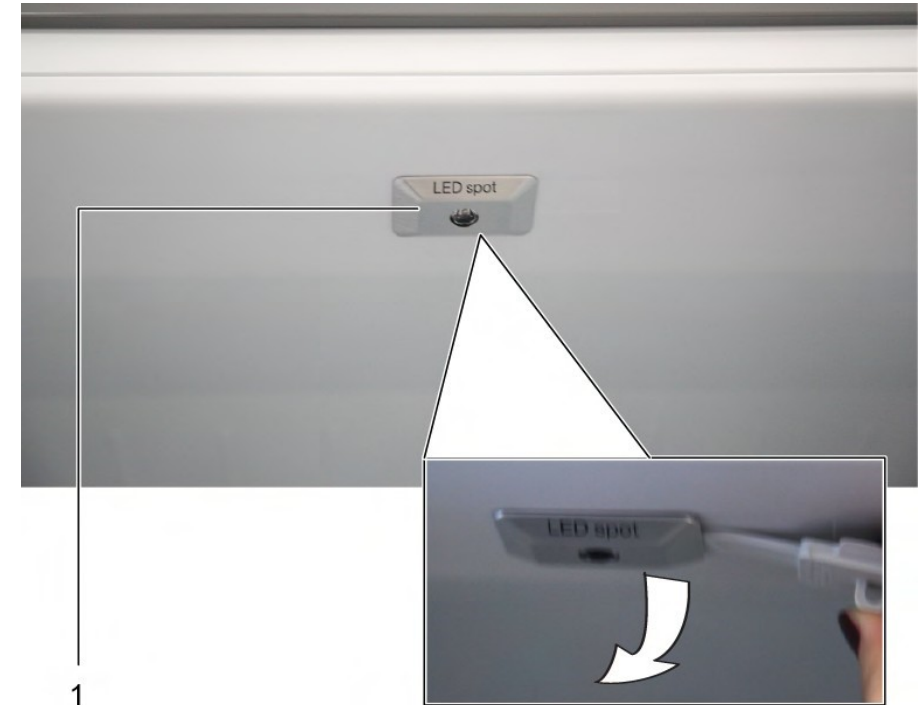

2. Irrota LED-kohdevalon sähköliitännät.
- ➔ LED-kohdevalo on poistettu.

4.14.2 LED-kohdevalon asennus

- ▶ Asenna vastakkaisessa järjestyksessä.

4.15 LED-ylävalon vaihtaminen

Erikoistyökalut:

-  Uraruuvimeisseli
- Terä 2,4 mm x 0,4 mm x 60 mm, pakkauksessa [00341820]

 Laite on varustettu huoltovapaalla LED-valolla. Vain huoltopalvelu tai valtuutetut teknikot saavat korjata nämä valot!

 **VAARA**
Jännitteisten osien aiheuttama sähköiskun vaara!
 Sähköiskusta aiheutuva hengenvaara väärän korjauksen tapauksessa

- ▶ Sähköosien korjaus tulisi antaa pätevien sähköasentajien suorittavaksi.
- ▶ Pyydä korjauksen jälkeen suorittamaan VDE 0701 -säädöksen tai maakontaisten säädösten mukainen turvallisuustesti.



 **VAARA**
Jännitteisten osien aiheuttama sähköiskun vaara!
 Sähköiskun aiheuttama kuolema

- ▶ Erotta laitteet sähkövirrasta vähintään 60 sekuntia ennen korjaustöiden aloittamista.

 **HUOMAA**
Terävät reunat!
 Viiltovammat

- ▶ Käytä suojakäsineitä.

Vaatus:

-  Kone on erotettu tehollähteestä.
-  Ovi on auki.
-  Sisällä olevat ylemmät lisävarusteet on poistettu.

4.15.1 LED-valon poistaminen

1. Siirrä LED-valo vasemmalle sivulle.



-  LED-valon sähköliitäntä on erotettu.

2. Avaa LED-valon lukitukset.



3. Poista LED-valo siirtämällä sitä etusuuntaan.

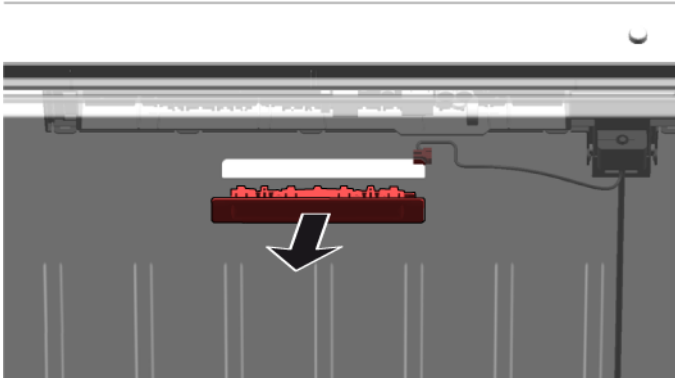

- ➔ LED-valo on poistettu.

4.15.2 LED-ylävalon asennus

- ▶ Asenna vastakkaisessa järjestyksessä.

4.16 LED-sivupalkkivalon vaihtaminen

Erikoistyökalut:

Imukuppi Ø50 mm [00342224]

 Laite on varustettu huoltovapaalla LED-valolla.
Vain huoltopalvelu tai valtuutetut teknikot saavat korjata nämä valot!

 **VAARA**
Jännitteisten osien aiheuttama sähköiskun vaara!
Sähköiskusta aiheutuva hengenvaara väärän korjauksen tapauksessa

- ▶ Sähköosien korjaus tulisi antaa pätevien sähköasentajien suoritettavaksi.
- ▶ Pyydä korjauksen jälkeen suorittamaan VDE 0701 -säädöksen tai maakohtaisten säädösten mukainen turvallisuustesti.

 **VAARA**
Jännitteisten osien aiheuttama sähköiskun vaara!
Sähköiskun aiheuttama kuolema

- ▶ Erotta laitteet sähkövirrasta vähintään 60 sekuntia ennen korjaustöiden aloittamista.

 **HUOMAA**
Terävät reunat!
Viiltovammat

- ▶ Käytä suojakäsineitä.

Vaatus:

- ✔ Kone on erotettu teholahteesta.
- ✔ Ovi on auki.
- ✔ Jääkaappiosan hyllyt on poistettu.

4.16.1 LED-sivupalkkivalon poistaminen

1. Kiinnitä imukuppi LED-sivupalkkivalon ylemmän kolmanneksen kohdalle.



2. Vedä imukuppi yhdessä LED-sivupalkkivalon kanssa yhdellä pyörivällä liikkeellä.

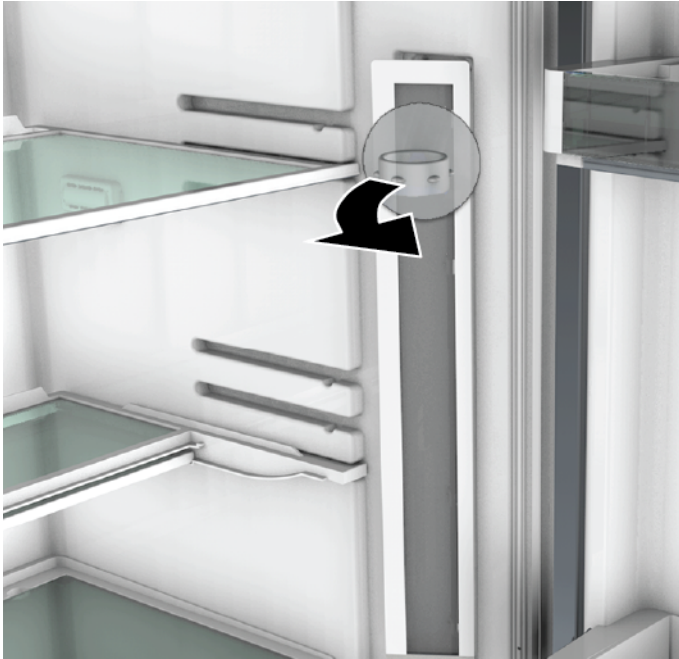



3. Irrota LED-sivupalkkivalon sähköliitäntä.
➡ LED-sivupalkkivalo on poistettu.

4.16.2 LED-sivupalkkivalon asennus

1. Kytke LED-sivupalkkivalon sähköliitäntä.
 2. Kiinnitä LED-sivupalkkivalo paikoilleen jääkaappiosan seinään (lukitukset napsahtavat).
- ➡ LED-sivupalkkivalo on asennettu.

4.17 LED-kohdevalon vaihtaminen

Erikoistyökalut:

-  Erikoistyökalu [00342180]
-  Uruuvimeisseli Terä 2,4 mm x 0,4 mm x 60 mm, pakkauksessa [00341820]

 Laite on varustettu huoltovapaalla LED-valolla. Vain huoltopalvelu tai valtuutetut teknikot saavat korjata nämä valot!

 **VAARA**
Jännitteisten osien aiheuttama sähköiskun vaara!
 Sähköiskusta aiheutuva hengenvaara väärän korjauksen tapauksessa

- ▶ Sähköosien korjaus tulisi antaa pätevien sähköasentajien suoritettavaksi.
- ▶ Pyydä korjauksen jälkeen suorittamaan VDE 0701 -säädöksen tai maakohtaisten säädösten mukainen turvallisuustesti.



 **VAARA**
Jännitteisten osien aiheuttama sähköiskun vaara!
 Sähköiskun aiheuttama kuolema

- ▶ Erotta laitteet sähkövirrasta vähintään 60 sekuntia ennen korjaustöiden aloittamista.

 **HUOMAA**
Terävät reunat!
 Viiltovammat

- ▶ Käytä suojakäsineitä.

Vaatus:

-  Kone on erotettu teholahteesta.
-  Ovi on auki.
-  Jääkaappiosan hyllyt on poistettu.

4.17.1 LED-kohdevalon poistaminen

1. Irrota LED-kohdevalon suojus.

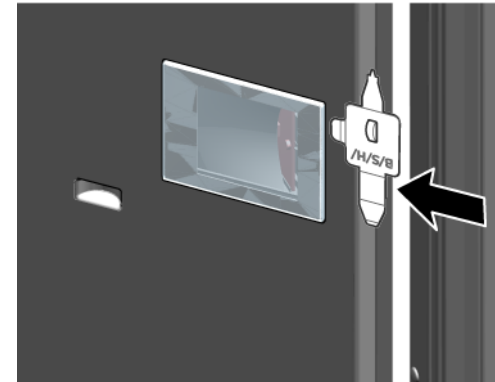

2. Vedä LED-kohdevalon suojusta sisäänpäin ja työnnä samalla eteenpäin.

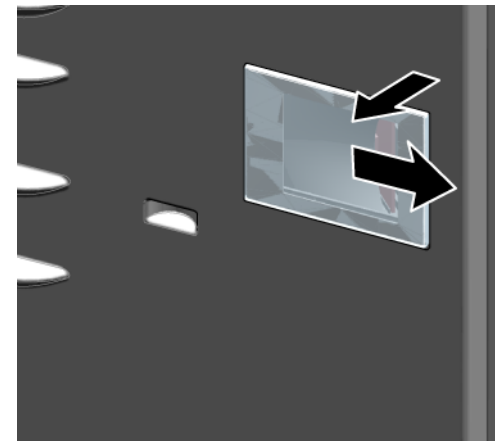

3. Irrota LED-kohdevalomoduuli.

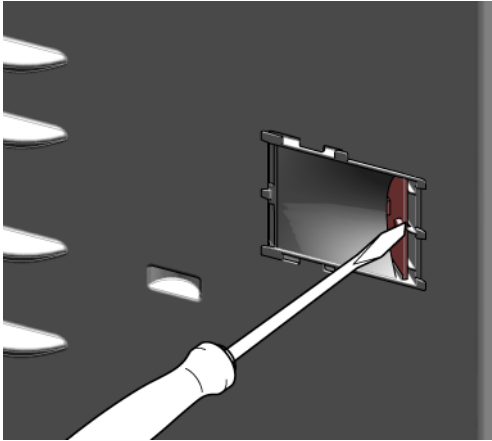

4. Irrota LED-kohdevalon sähköliitäntä.

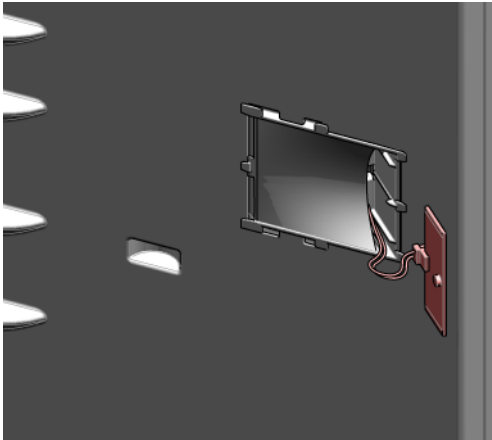

 LED-kohdevalo on poistettu.

4.17.2 LED-kohdevalon asennus

- ▶ Asenna vastakkaisessa järjestyksessä.

Conseils de réparation - Réfrigérateur / Congélateur combiné

A propos de ce document..... 235

1.1 Informations importantes.....	235
1.1.1 Objectif.....	235
1.2 Explication des symboles.....	235
1.2.1 Niveaux de risque.....	235
1.2.2 Symboles de danger.....	235
1.2.3 Structure des indications d'avertissement.....	236
1.2.4 Symboles généraux.....	236

Sécurité..... 237

2.1 Consignes de sécurité générales.....	237
2.1.1 Tous les appareils électroménagers.....	237

Outils et aides..... 238

Réparation..... 239

4.1 Remplacer le joint de porte.....	239
4.1.1 Retirer le joint de porte.....	239
4.1.2 Monter le joint de porte.....	239
4.2 Remplacer la poignée de porte.....	242
4.2.1 Retirer la poignée de porte.....	242
4.2.2 Monter la poignée de porte.....	242
4.3 Remplacer la charnière supérieure de la porte.....	243
4.3.1 Retirer la charnière supérieure de la porte.....	243
4.3.2 Monter la charnière supérieure de la porte.....	244
4.4 Remplacer la charnière supérieure de la porte (porte avec afficheur).....	245
4.4.1 Retirer la charnière supérieure de la porte.....	245
4.4.2 Monter la charnière supérieure de la porte.....	246
4.5 Remplacer la charnière intermédiaire de la porte.....	247
4.5.1 Retirer la charnière intermédiaire de la porte.....	247
4.5.2 Monter la charnière intermédiaire de la porte.....	247
4.6 Remplacer la charnière de porte inférieure.....	248
4.6.1 Retirer la charnière intermédiaire de la porte.....	248
4.6.2 Monter la charnière de porte inférieure.....	248
4.7 Remplacer la tablette.....	249
4.7.1 Retirer la tablette.....	249
4.7.2 Monter la tablette.....	249

4.8 Remplacer le casier à bouteilles.....	250
4.8.1 Retirer le casier à bouteilles.....	250
4.8.2 Monter le casier à bouteilles.....	250
4.9 Remplacer l'étagère de la porte.....	251
4.9.1 Retirer l'étagère de la porte.....	251
4.9.2 Monter l'étagère de la porte.....	251
4.10 Remplacer l'étagère ajustable de la porte.....	252
4.10.1 Retirer l'étagère ajustable de la porte.....	252
4.10.2 Monter l'étagère ajustable de la porte.....	252
4.11 Remplacer le bac d'aliments congelés.....	253
4.11.1 Retirer le bac d'aliments congelés.....	253
4.11.2 Monter le bac d'aliments congelés.....	253
4.12 Remplacer le bac.....	254
4.12.1 Retirer le bac.....	254
4.12.2 Monter le bac.....	254
4.13 Remplacer le bac télescopique.....	255
4.13.1 Extraire le bac télescopique.....	255
4.13.2 Monter le bac télescopique.....	255
4.14 Changer le projecteur LED.....	256
4.14.1 Démontage du projecteur LED.....	256
4.14.2 Monter le projecteur LED.....	256
4.15 Remplacer l'éclairage LED supérieur.....	257
4.15.1 Retirer l'éclairage LED.....	257
4.15.2 Monter l'éclairage LED supérieur.....	258
4.16 Echange de l'éclairage LED latéral.....	259
4.16.1 Démontage de l'éclairage LED latéral.....	259
4.16.2 Montage de l'éclairage LED latéral.....	260
4.17 Changer le projecteur LED.....	261
4.17.1 Démontage du projecteur LED.....	261
4.17.2 Monter le projecteur LED.....	262

i A propos de ce document

1.1 Informations importantes

1.1.1 Objectif

Les conseils de réparation qui suivent visent à permettre au consommateur de réparer l'appareil par lui-même, conformément au règlement sur l'écoconception (en vigueur le 03/2021).

Ils contiennent des informations sur le remplacement de certaines pièces de rechange précises, y compris des mises en garde.

Pour toute question, veuillez contacter notre service après-vente. Notre responsabilité pour les dommages est conditionnelle à l'observation des conseils de réparation.

1.2 Explication des symboles

1.2.1 Niveaux de risque

Les niveaux de risque se composent d'un symbole et d'un terme d'avertissement. Le mot d'avertissement caractérise la gravité du danger.









Niveau de dangerosité	Signification
 DANGER	Le non respect de la consigne d'avertissement provoque la mort ou des blessures graves.
 AVERTISSEMENT	Le non respect de la consigne d'avertissement peut provoquer la mort ou des blessures graves.
 PRUDENCE	Le non respect de la consigne d'avertissement peut provoquer des blessures légères.
 ATTENTION !	Le non respect de la consigne d'avertissement peut provoquer des dégâts matériels.

Tableau 1: Niveaux de risque

1.2.2 Symboles de danger

Les symboles de danger sont des représentations figuratives renseignant sur la nature du danger.

Ce document utilise les symboles de danger suivants:

Symbole de danger	Signification
	Consigne d'avertissement générale
	Danger engendré par la tension électrique
	Risque d'explosion
	Risque de blessures par coupure

i A propos de ce document





Symbole de danger	Signification
	Risque de blessures par écrasement
	Danger engendré par des surfaces très chaudes
	Danger engendré par un champ magnétique puissant
	Danger engendré par un rayonnement non ionisant

Tableau 2: Symboles de danger

1.2.3 Structure des indications d'avertissement

Les consignes d'avertissement figurant dans ce document ont un aspect uniforme et une structure uniforme.

	<p>⚠ DANGER</p> <p>Type et source du danger ! Conséquences possibles en cas de non-respect du danger / de l'avertissement.</p> <ul style="list-style-type: none"> ▶ Mesures et interdictions pour éviter le danger.
--	---

L'exemple suivant montre une consigne d'avertissement mettant en garde contre le risque d'électrocution. La mesure permettant d'éviter le danger est nommée.

	<p>⚠ DANGER</p> <p>Risque d'électrocution par des pièces conductrices de tension ! Mort par électrocution.</p> <ul style="list-style-type: none"> ▶ Débrancher l'appareil du secteur minimum 60 secondes avant de démarrer la réparation.
--	---

1.2.4 Symboles généraux

Ce document utilise les symboles généraux suivants:







Symbole général	Signification
	Caractérisation d'une astuce particulière (texte et/ou graphique)
	Caractérisation d'une astuce simple (texte seul)
	Caractérisation d'un lien vers une vidéo
	Caractérisation d'outils nécessaires
	Caractérisation de conditions nécessaires
	Caractérisation d'une condition (si... , alors ...)
	Caractérisation d'un résultat
Start	Caractérisation d'une touche ou surface de commande
[00123456]	Caractérisation d'une référence de pièce
Statut	Caractérisation d'un texte affiché / fenêtre (sur l'afficheur)

Tableau 3: Symboles généraux

2.1 Consignes de sécurité générales

2.1.1 Tous les appareils électroménagers

Risque d'électrocution en raison de pièces sous tension!

- Des erreurs lors de réparations impliquant des composants électriques peuvent entraîner une décharge électrique!
- Débrancher l'appareil du secteur minimum 60 secondes avant de démarrer la réparation.
- Après la réparation, effectuer un test de sécurité selon VDE 0701 ou les réglementations spécifiques nationales.

Risque de blessures par coupure sur des bords tranchants!

- Porter des gants de protection.

Risque de casse durant la réparation, maintenance, dépannage et SAV en raison de composants lourds et mobiles

- Porter des chaussures de protection.
- Sécuriser les composants lourds contre le risque de chute.
- Ne pas coller les pièces du châssis sur les composants mobiles.





Risque lié à la sécurité / fonction de l'appareil!

- Utiliser uniquement des pièces détachées d'origine.

Risque d'endommagement des composants sensibles aux décharges électrostatiques!

- Ne pas toucher les modules, ni leur connexions et pistes conductrices.

Outils et aides

Désignation	Détails	Images
Tissu de protection [00342013]	60 cm x 50 cm	
Tournevis plat	Lame 2.4 mm x 0.4 mm x 60 mm, dans le kit [00341820]	
Outil spécial [00342180]		
Ventouse [00342224]	Ø50 mm	
Embout Torx TX20 [00340865]	6,3 mm (1/4")	
Tournevis plat	Lame 10 mm x 1,6 mm x 200 mm	

4.1 Remplacer le joint de porte

Pré-requis:

- ✔ La porte est ouverte.

4.1.1 Retirer le joint de porte

1. Sortir le joint de porte de la rainure dans les coins gauche et droit.





2. Retirer le joint de porte de la rainure.



- ➡ Le joint de porte est retiré.

4.1.2 Monter le joint de porte

	L'épaisseur du nouveau joint de porte peut différer légèrement de celle de l'ancien. Cela n'affectera en rien la fermeture ou le fonctionnement à long terme de la porte.
	Si votre appareil est doté de charnière ou d'attaches de charnières ajustables, vous pourrez optimiser le comportement de fermeture par la suite.
	Les petits trous latéraux dans les joints de porte sont fonctionnels (nécessaires pour la ventilation). Il ne s'agit pas de défauts de production.

Réparation

1. S'assurer de l'absence de dégâts dans les rainures qui doivent accueillir le joint.



4. Pousser les coins du joint en haut et en bas dans la rainure.

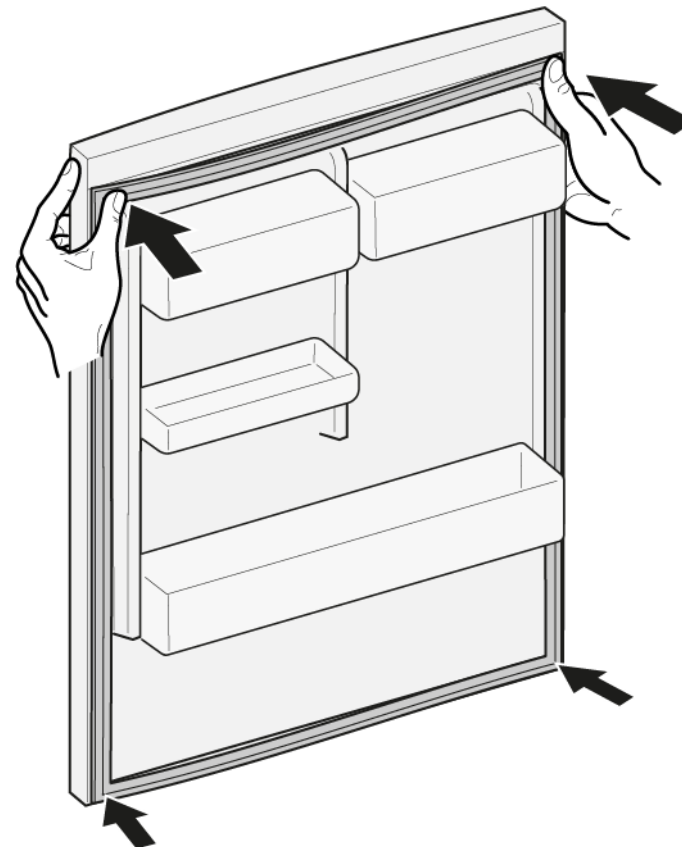

2.  Si la rainure de joint est endommagée.
- Contacter le service après-vente.

3.  Une légère déformation du joint est normale et ne saurait en affecter le fonctionnement. Il est recommandé de redresser le joint de porte avant de l'insérer dans l'appareil.

Réchauffer le joint de porte avec un sèche-cheveux ou de l'eau chaude et le reformer manuellement.

Réparation



5. Enfoncer progressivement le joint dans la rainure.





-  Le joint de porte est installé.

4.2 Remplacer la poignée de porte

Outillage nécessaire:

-  Embout Torx TX20 6,3 mm (1/4") [00340865]
-  Tournevis plat Lame 10 mm x 1,6 mm x 200 mm

Pré-requis:

-  Appareil est déconnecté de l'alimentation.
-  La porte est ouverte.

4.2.1 Retirer la poignée de porte

- ▶ 1. Retirer deux capuchons de vis (1).
- ▶ 2. Dévisser deux vis (2).
- ▶ 3. Retirer la poignée de porte (3).

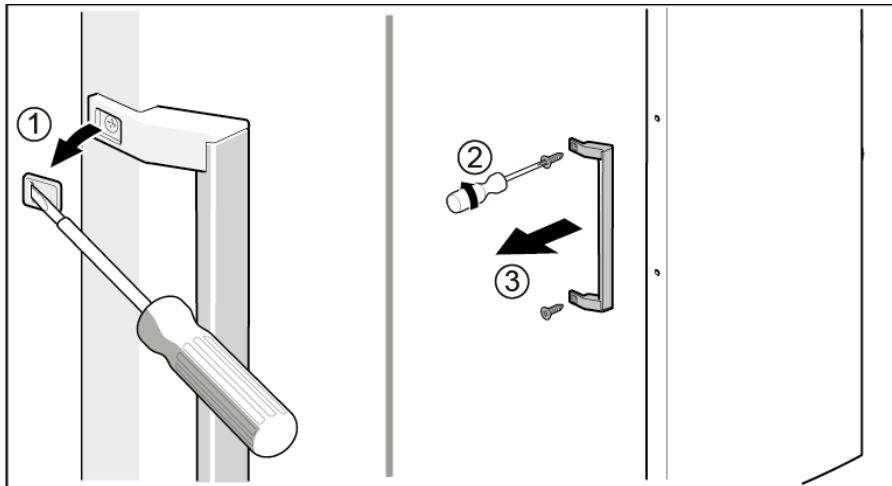

 La poignée de porte est retirée.



La poignée de la deuxième porte peut être retirée de la même manière.

4.2.2 Monter la poignée de porte

- ▶ Le montage s'effectue dans l'ordre chronologique inverse.

4.3 Remplacer la charnière supérieure de la porte

Outillage nécessaire:

🌀 Embout Torx TX20 6,3 mm (1/4") [00340865]

	⚠️ AVERTISSEMENT
Appareils lourds et volumineux ! Blessures dorsales et musculaires <ul style="list-style-type: none"> ▶ Seuls des spécialistes dûment formés devraient retirer la porte de l'appareil. ▶ Pour déplacer l'appareil, deux personnes sont nécessaires. ▶ Utiliser seulement des outils et de l'équipement appropriés. 	

	⚠️ PRUDENCE
Arêtes vives ! Blessures par coupure <ul style="list-style-type: none"> ▶ Porter des gants de protection. 	

	⚠️ AVERTISSEMENT
Chute d'appareils inclinés ! Fractures/blessures d'écrasement <ul style="list-style-type: none"> ▶ Sécuriser les appareils contre le risque de chute. 	

	⚠️ PRUDENCE
Risque de pièces qui chutent en raison de vis trop lâches ! Blessures dues à des pièces qui chutent. <ul style="list-style-type: none"> ▶ Sécuriser les composants contre le risque de chute. 	

	ATTENTION !
Risque de pièces qui chutent en raison de vis trop lâches ! Dommages à d'autres parties de l'appareil ou à la propriété du client, p. ex. au plancher. <ul style="list-style-type: none"> ▶ Sécuriser les composants contre le risque de chute. 	

Pré-requis:

- ✔ Appareil est déconnecté de l'alimentation.
- ✔ Les équipements intérieurs de l'appareil sont retirés.

4.3.1 Retirer la charnière supérieure de la porte

1. Placer l'appareil sur le dos.

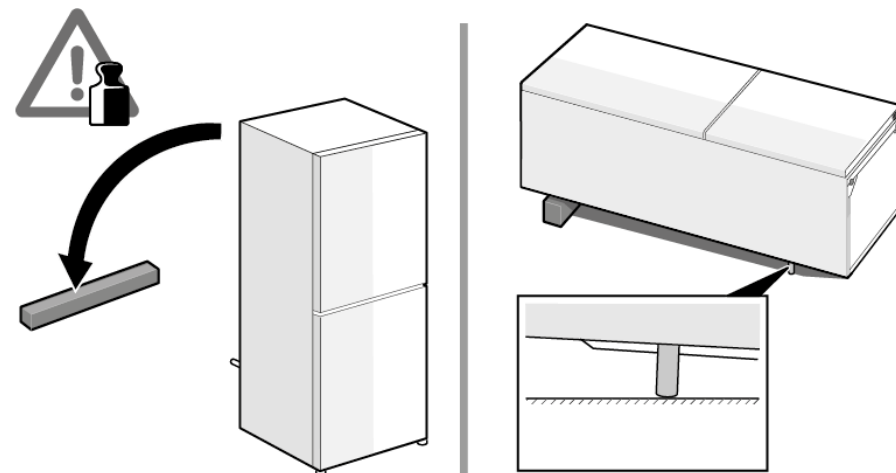

Réparation

2. 1. Appuyer sur le cache de charnière supérieure des deux côtés (1).
2. Sortir le cache de charnière supérieure (2).
3. Faire pivoter le cache de la charnière (3).
4. Retirer le cache de la charnière supérieure (4).
5. Dévisser deux vis (5).
6. Retirer la charnière supérieure (6).

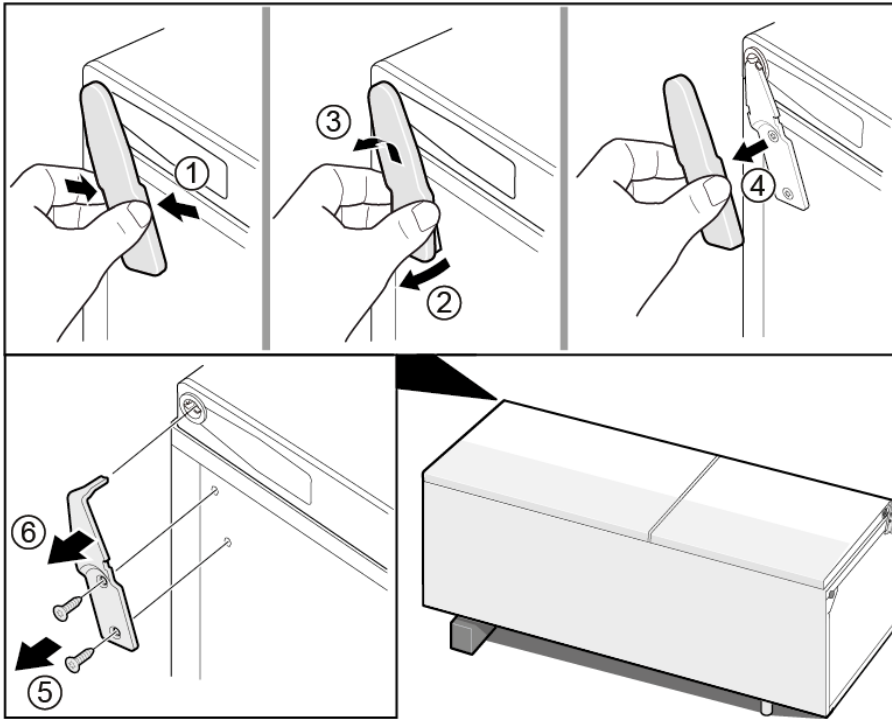

 La charnière supérieure est retirée.

4.3.2 Monter la charnière supérieure de la porte

- ▶ Le montage s'effectue dans l'ordre chronologique inverse.

4.4 Remplacer la charnière supérieure de la porte (porte avec afficheur)

Outillage nécessaire:

🌀 Embout Torx TX20 6,3 mm (1/4") [00340865]

	⚠️ AVERTISSEMENT
	<p>Appareils lourds et volumineux ! Blessures dorsales et musculaires</p> <ul style="list-style-type: none"> ▶ Seuls des spécialistes dûment formés devraient retirer la porte de l'appareil. ▶ Pour déplacer l'appareil, deux personnes sont nécessaires. ▶ Utiliser seulement des outils et de l'équipement appropriés.

	⚠️ PRUDENCE
	<p>Arêtes vives ! Blessures par coupure</p> <ul style="list-style-type: none"> ▶ Porter des gants de protection.

	⚠️ AVERTISSEMENT
	<p>Chute d'appareils inclinés ! Fractures/blessures d'écrasement</p> <ul style="list-style-type: none"> ▶ Sécuriser les appareils contre le risque de chute.

	⚠️ PRUDENCE
	<p>Risque de pièces qui chutent en raison de vis trop lâches ! Blessures dues à des pièces qui chutent.</p> <ul style="list-style-type: none"> ▶ Sécuriser les composants contre le risque de chute.

	ATTENTION !
	<p>Risque de pièces qui chutent en raison de vis trop lâches ! Dommages à d'autres parties de l'appareil ou à la propriété du client, p. ex. au plancher.</p> <ul style="list-style-type: none"> ▶ Sécuriser les composants contre le risque de chute.

	⚠️ DANGER
	<p>Risque d'électrocution en raison de pièces sous tension ! Risque d'électrocution en cas de réparation non conforme</p> <ul style="list-style-type: none"> ▶ Les pièces électriques doivent être réparées par des techniciens qualifiés. ▶ Après la réparation, effectuer un test de sécurité selon VDE 0701 ou les réglementations spécifiques nationales.

	⚠️ DANGER
	<p>Risque d'électrocution par des pièces conductrices de tension ! Mort par électrocution.</p> <ul style="list-style-type: none"> ▶ Débrancher l'appareil du secteur minimum 60 secondes avant de démarrer la réparation.

Pré-requis:

- ✓ Appareil est déconnecté de l'alimentation.
- ✓ Les équipements intérieurs de l'appareil sont retirés.

4.4.1 Retirer la charnière supérieure de la porte

1. Placer l'appareil sur le dos.

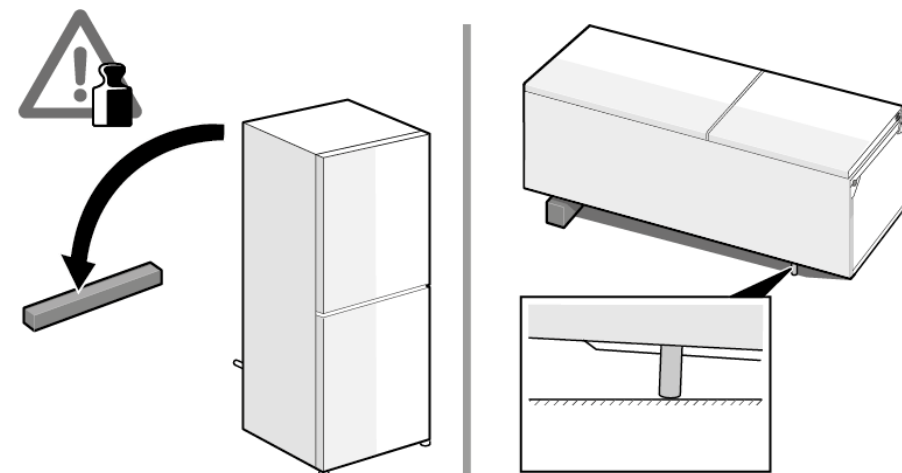

Réparation

2. 1. Retirer le cache de la charnière supérieure (1).
2. Retirer le couvercle de la boîte de câbles (2).
3. Débrancher la connexion électrique (3).
4. Dévisser la vis de mise à la terre (4).
5. Retirer la protection du câble (5).
6. Dévisser la vis (6).

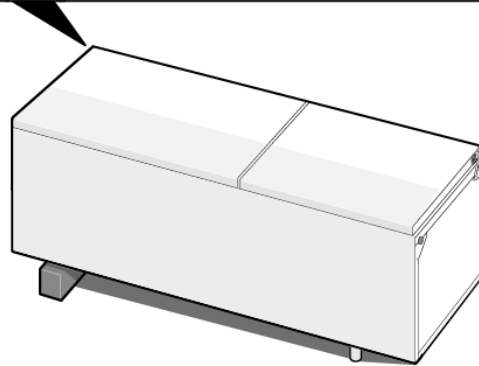
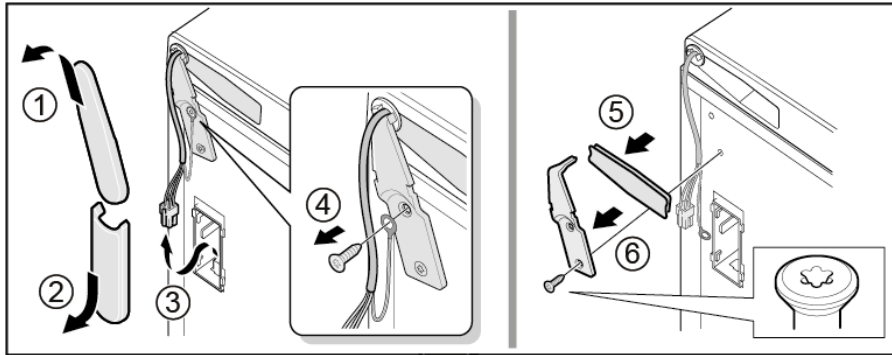

 La charnière supérieure est retirée.

4.4.2 Monter la charnière supérieure de la porte

- ▶ Le montage s'effectue dans l'ordre chronologique inverse.

4.5 Remplacer la charnière intermédiaire de la porte

Outillage nécessaire:

🌀 Embout Torx TX20 6,3 mm (1/4") [00340865]

	⚠️ AVERTISSEMENT
Appareils lourds et volumineux !	
Blessures dorsales et musculaires	
<ul style="list-style-type: none"> ▶ Seuls des spécialistes dûment formés devraient retirer la porte de l'appareil. ▶ Pour déplacer l'appareil, deux personnes sont nécessaires. ▶ Utiliser seulement des outils et de l'équipement appropriés. 	

	⚠️ PRUDENCE
Arêtes vives !	
Blessures par coupure	
<ul style="list-style-type: none"> ▶ Porter des gants de protection. 	

	⚠️ AVERTISSEMENT
Chute d'appareils inclinés !	
Fractures/blessures d'écrasement	
<ul style="list-style-type: none"> ▶ Sécuriser les appareils contre le risque de chute. 	

	⚠️ PRUDENCE
Risque de pièces qui chutent en raison de vis trop lâches !	
Blessures dues à des pièces qui chutent.	
<ul style="list-style-type: none"> ▶ Sécuriser les composants contre le risque de chute. 	

	ATTENTION !
Risque de pièces qui chutent en raison de vis trop lâches !	
Dommages à d'autres parties de l'appareil ou à la propriété du client, p. ex. au plancher.	
<ul style="list-style-type: none"> ▶ Sécuriser les composants contre le risque de chute. 	

Pré-requis:

- ✔️ Appareil est déconnecté de l'alimentation.
- ✔️ Les équipements intérieurs de l'appareil sont retirés.
- ✔️ La charnière supérieure de la porte est retirée.

4.5.1 Retirer la charnière intermédiaire de la porte

- ▶ 1. Retirer la porte du compartiment réfrigérateur (1).
- ▶ 2. Dévisser deux vis (2).
- ▶ 3. Retirer la charnière intermédiaire (3).

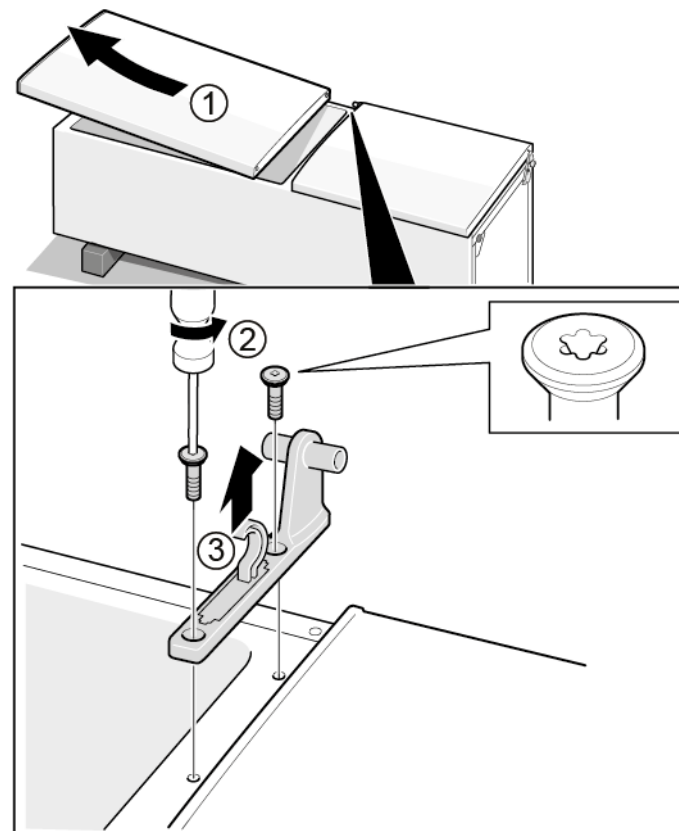

➡ La charnière intermédiaire est retirée.

4.5.2 Monter la charnière intermédiaire de la porte

- ▶ Le montage s'effectue dans l'ordre chronologique inverse.

4.6 Remplacer la charnière de porte inférieure

Outillage nécessaire:

🌀 Embout Torx TX20 6,3 mm (1/4") [00340865]

	⚠️ AVERTISSEMENT
	<p>Appareils lourds et volumineux ! Blessures dorsales et musculaires</p> <ul style="list-style-type: none"> ▶ Seuls des spécialistes dûment formés devraient retirer la porte de l'appareil. ▶ Pour déplacer l'appareil, deux personnes sont nécessaires. ▶ Utiliser seulement des outils et de l'équipement appropriés.

	⚠️ PRUDENCE
	<p>Arêtes vives ! Blessures par coupure</p> <ul style="list-style-type: none"> ▶ Porter des gants de protection.

	⚠️ AVERTISSEMENT
	<p>Chute d'appareils inclinés ! Fractures/blessures d'écrasement</p> <ul style="list-style-type: none"> ▶ Sécuriser les appareils contre le risque de chute.

	⚠️ PRUDENCE
	<p>Risque de pièces qui chutent en raison de vis trop lâches ! Blessures dues à des pièces qui chutent.</p> <ul style="list-style-type: none"> ▶ Sécuriser les composants contre le risque de chute.

	ATTENTION !
	<p>Risque de pièces qui chutent en raison de vis trop lâches ! Dommages à d'autres parties de l'appareil ou à la propriété du client, p. ex. au plancher.</p> <ul style="list-style-type: none"> ▶ Sécuriser les composants contre le risque de chute.

Pré-requis:

- ✔️ Appareil est déconnecté de l'alimentation.
- ✔️ Les équipements intérieurs de l'appareil sont retirés.
- ✔️ La charnière supérieure est retirée.

✔️ La charnière intermédiaire est retirée.

4.6.1 Retirer la charnière intermédiaire de la porte

- ▶ 1. Retirer la porte du compartiment congélateur (1).
- ▶ 2. Dévisser la vis (2).
- ▶ 3. Extraire la charnière inférieure en la tournant (3).
- ▶ 4. Retirer la charnière inférieure (4).

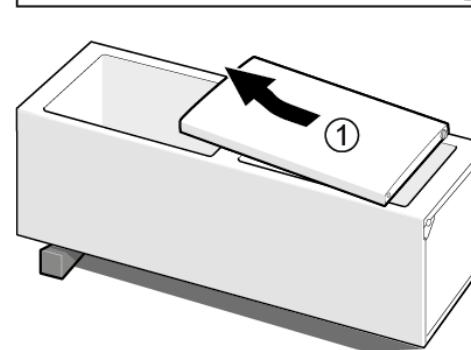
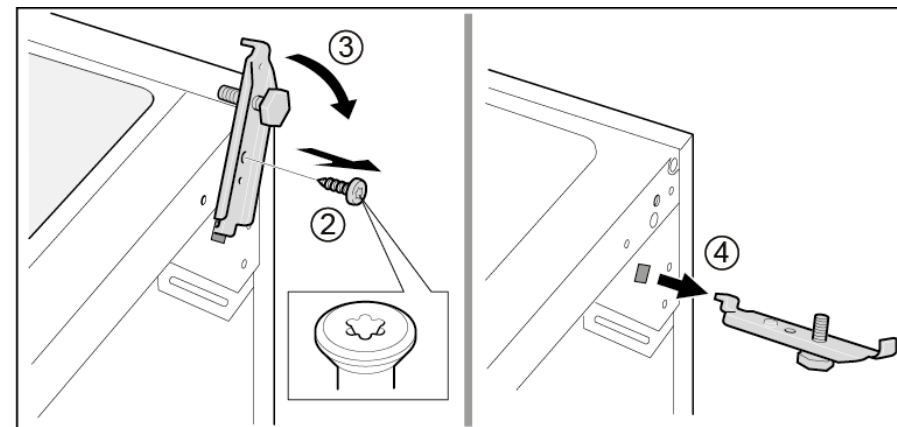

➡ La charnière inférieure de la porte est retirée.

4.6.2 Monter la charnière de porte inférieure

- ▶ Le montage s'effectue dans l'ordre chronologique inverse.

4.7 Remplacer la tablette

Pré-requis:

- ✔ La porte est ouverte.

4.7.1 Retirer la tablette

- ▶ Extraire la tablette.

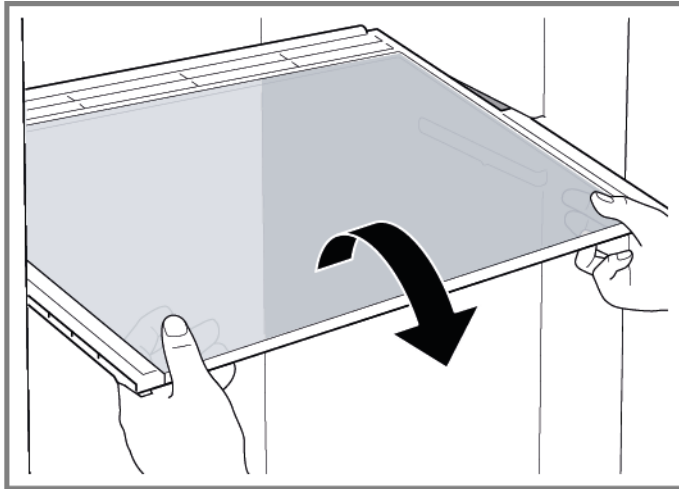

- ➡ La tablette est retirée.

4.7.2 Monter la tablette

- ▶ Le montage s'effectue dans l'ordre chronologique inverse.

4.8 Remplacer le casier à bouteilles

Pré-requis:

- ✔ La porte est ouverte.

4.8.1 Retirer le casier à bouteilles

- ▶ Extraire le casier à bouteilles.

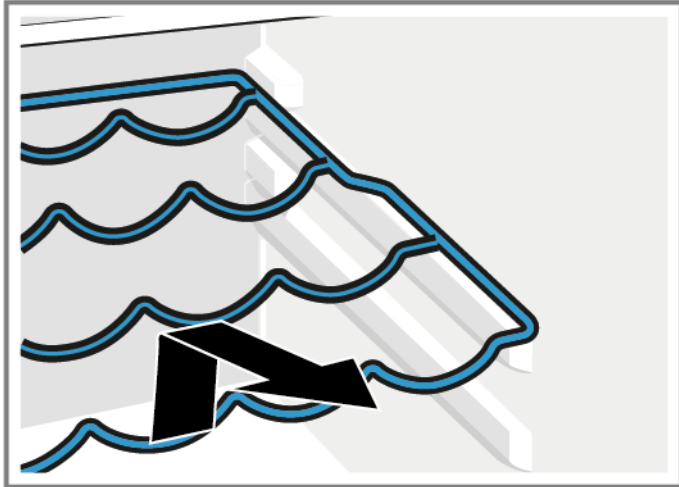

- ➡ Le casier à bouteilles est retiré.

4.8.2 Monter le casier à bouteilles

- ▶ Le montage s'effectue dans l'ordre chronologique inverse.

4.9 Remplacer l'étagère de la porte

Pré-requis:

- ✔ La porte est ouverte.

4.9.1 Retirer l'étagère de la porte

- ▶ Soulever l'étagère de la porte.

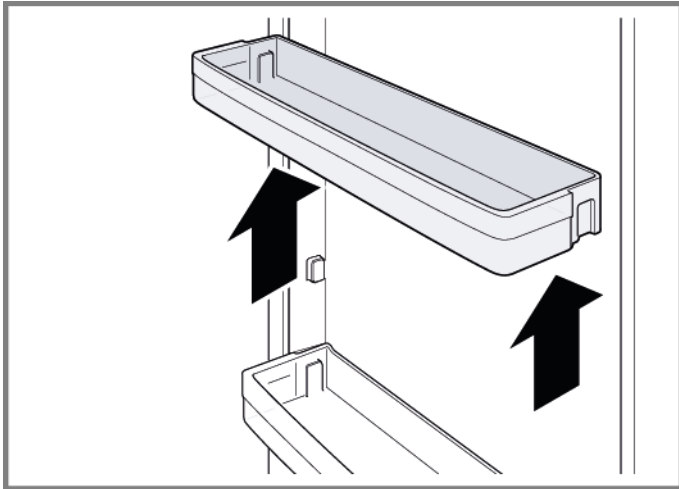

➡ L'étagère de la porte est retirée.

4.9.2 Monter l'étagère de la porte

- ▶ Le montage s'effectue dans l'ordre chronologique inverse.

4.10 Remplacer l'étagère ajustable de la porte

Pré-requis:

- ✔ La porte est ouverte.

4.10.1 Retirer l'étagère ajustable de la porte

- ▶ Relever l'étagère ajustable en hauteur de la porte jusqu'à ce qu'elle soit libérée de son support.

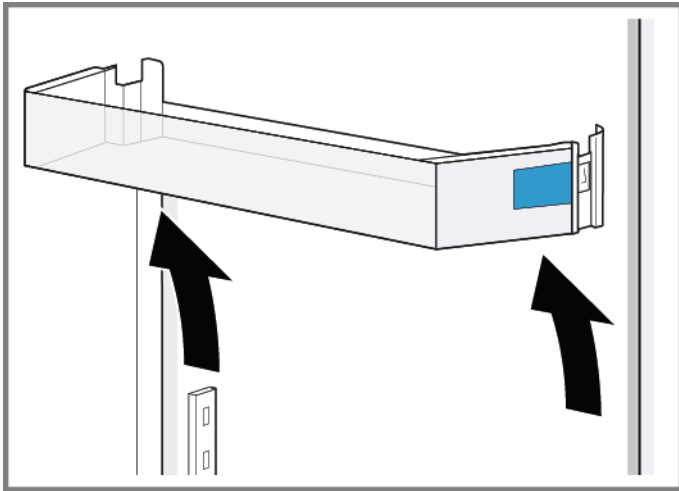

- ➡ L'étagère ajustable de la porte est retirée.

4.10.2 Monter l'étagère ajustable de la porte

- ▶ Le montage s'effectue dans l'ordre chronologique inverse.

4.11 Remplacer le bac d'aliments congelés

Pré-requis:

- ✔ La porte est ouverte.

4.11.1 Retirer le bac d'aliments congelés

- ▶ 1. Extraire complètement le bac d'aliments congelés (1).
- ▶ 2. Retirer le bac d'aliments (2).

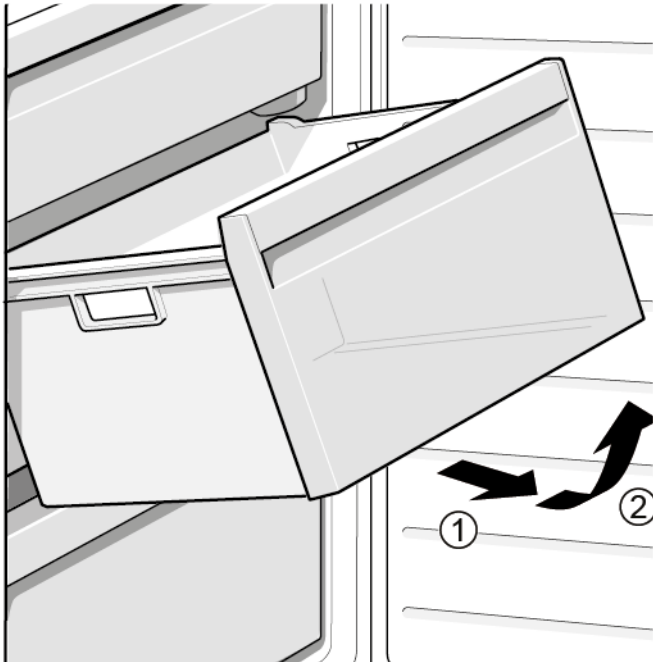

- ➡ Le bac d'aliments congelés est retiré.

4.11.2 Monter le bac d'aliments congelés

- ▶ Le montage s'effectue dans l'ordre chronologique inverse.

4.12 Remplacer le bac

Pré-requis:

- ✔ La porte est ouverte.

4.12.1 Retirer le bac

- ▶ 1. Extraire le bac inférieur du réfrigérateur (1).
- ▶ 2. Extraire le bac supérieur du réfrigérateur (2).

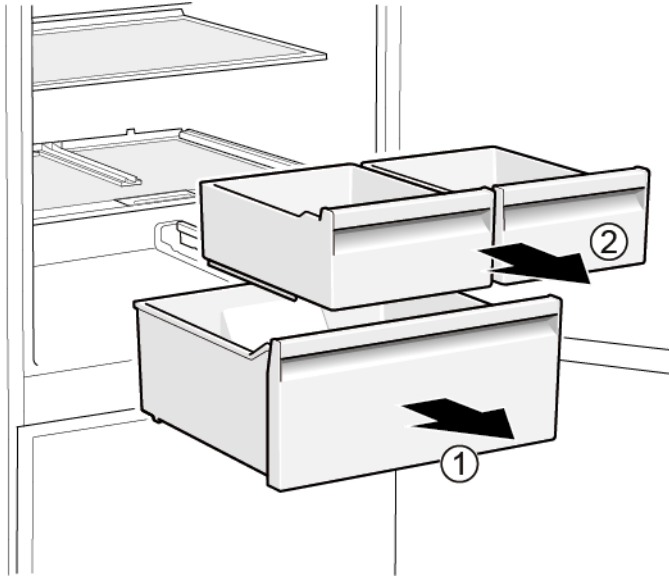

- ➡ Les bacs sont retirés.

4.12.2 Monter le bac

- ▶ Le montage s'effectue dans l'ordre chronologique inverse.

4.13 Remplacer le bac télescopique

Pré-requis:

- ✔ La porte est ouverte.

4.13.1 Extraire le bac télescopique

- ▶ 1. Extraire complètement le bac télescopique (1).
- ▶ 2. Retirer le bac télescopique (2).

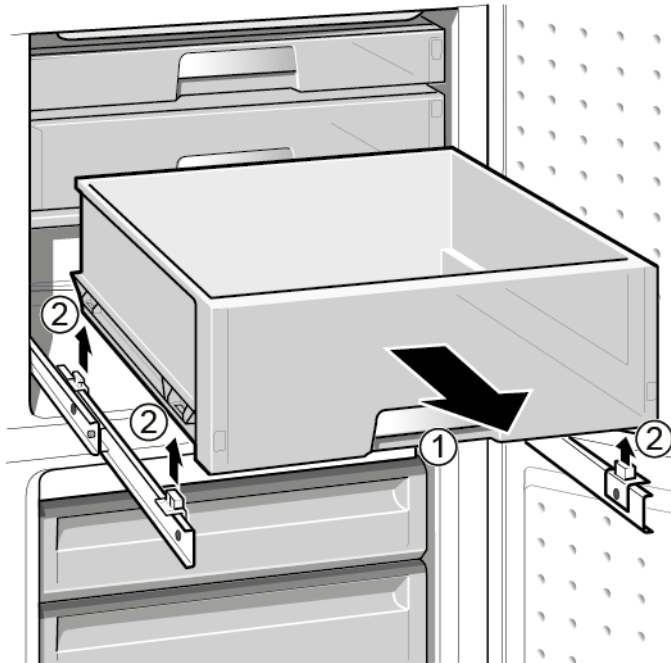

- ➡ Le bac télescopique est retiré.

4.13.2 Monter le bac télescopique

- ▶ Le montage s'effectue dans l'ordre chronologique inverse.

4.14 Changer le projecteur LED

Outillage nécessaire:

🔧 Outil spécial [00342180]



Votre appareil est équipé d'un éclairage LED ne demandant pas d'entretien.
Les réparations de cet éclairage sont exclusivement réservées au service après-vente ou à des spécialistes autorisés!



⚠️ DANGER

Risque d'électrocution en raison de pièces sous tension !

Risque d'électrocution en cas de réparation non conforme

- ▶ Les pièces électriques doivent être réparées par des techniciens qualifiés.
- ▶ Après la réparation, effectuer un test de sécurité selon VDE 0701 ou les régulations spécifiques nationales.



⚠️ DANGER

Risque d'électrocution par des pièces conductrices de tension !

Mort par électrocution.

- ▶ Débrancher l'appareil du secteur minimum 60 secondes avant de démarrer la réparation.



⚠️ PRUDENCE

Arêtes vives !

Blessures par coupure

- ▶ Porter des gants de protection.

Pré-requis:

- ✔ Appareil est déconnecté de l'alimentation.
- ✔ La porte est ouverte.

4.14.1 Démontage du projecteur LED

1. Retirer le projecteur LED à l'aide d'un outil spécial (1).

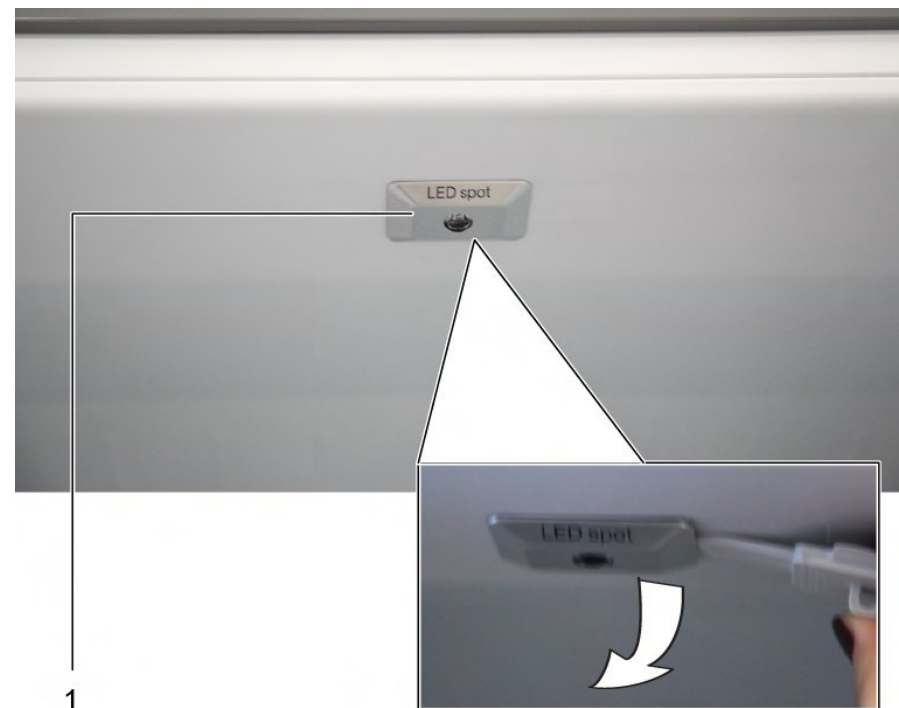

2. Retirer les raccords électriques du projecteur LED.

➡ Le projecteur LED est retiré.

4.14.2 Monter le projecteur LED

- ▶ Le montage s'effectue dans l'ordre chronologique inverse.

4.15 Remplacer l'éclairage LED supérieur

Outillage nécessaire:

- 🔧 Tournevis plat Lame 2.4 mm x 0.4 mm x 60 mm, dans le kit [00341820]



Votre appareil comprend un éclairage LED sans maintenance. Ces lampes peuvent être réparées exclusivement par le service après-vente ou un technicien autorisé.



⚠️ DANGER

Risque d'électrocution en raison de pièces sous tension !

Risque d'électrocution en cas de réparation non conforme

- ▶ Les pièces électriques doivent être réparées par des techniciens qualifiés.
- ▶ Après la réparation, effectuer un test de sécurité selon VDE 0701 ou les réglementations spécifiques nationales.



⚠️ DANGER

Risque d'électrocution par des pièces conductrices de tension !

Mort par électrocution.

- ▶ Débrancher l'appareil du secteur minimum 60 secondes avant de démarrer la réparation.



⚠️ PRUDENCE

Arêtes vives !

Blessures par coupure

- ▶ Porter des gants de protection.

Pré-requis:

- ✔ Appareil est déconnecté de l'alimentation.
- ✔ La porte est ouverte.
- ✔ Les équipements intérieurs supérieurs de l'appareil sont retirés.

4.15.1 Retirer l'éclairage LED

1. Déplacer l'éclairage LED vers la gauche.

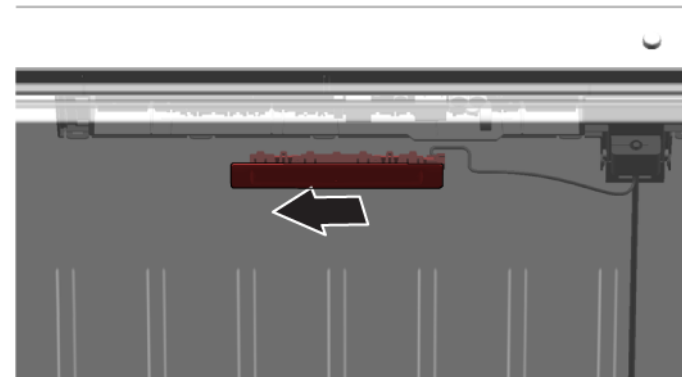

- ➡ Connexion électrique de l'éclairage LED est débranchée.

2. Libérer les crochets de l'éclairage LED.

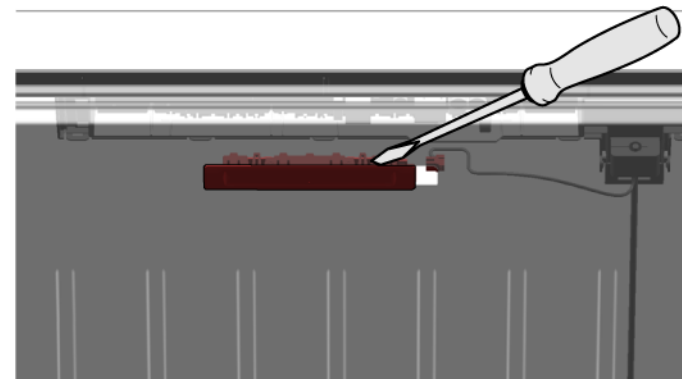

3. Retirer l'éclairage LED par l'avant.

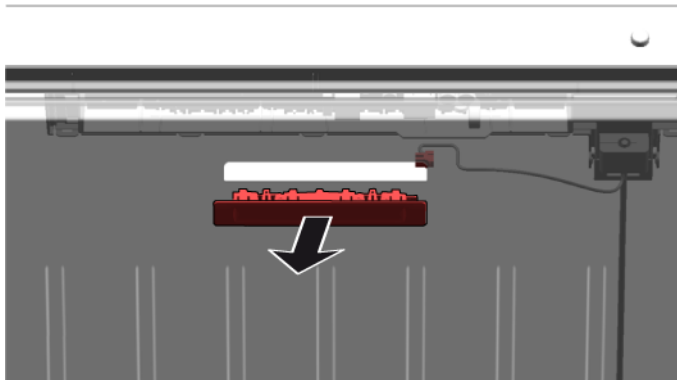

- ➡ L'éclairage LED est retiré.

4.15.2 Monter l'éclairage LED supérieur

- ▶ Le montage s'effectue dans l'ordre chronologique inverse.

4.16 Echange de l'éclairage LED latéral

Outillage nécessaire:

 Ventouse Ø50 mm [00342224]



Votre appareil est équipé d'un éclairage LED ne demandant pas d'entretien.
Les réparations de cet éclairage sont exclusivement réservées au service après-vente ou à des spécialistes autorisés!



DANGER

Risque d'électrocution en raison de pièces sous tension !

Risque d'électrocution en cas de réparation non conforme

- ▶ Les pièces électriques doivent être réparées par des techniciens qualifiés.
- ▶ Après la réparation, effectuer un test de sécurité selon VDE 0701 ou les réglementations spécifiques nationales.



DANGER

Risque d'électrocution par des pièces conductrices de tension !

Mort par électrocution.

- ▶ Débrancher l'appareil du secteur minimum 60 secondes avant de démarrer la réparation.





PRUDENCE

Arêtes vives !

Blessures par coupure

- ▶ Porter des gants de protection.

Pré-requis:

-  Appareil est déconnecté de l'alimentation.
-  La porte est ouverte.
-  Les clayettes du réfrigérateur sont retirées.

4.16.1 Démontage de l'éclairage LED latéral

1. Fixer la ventouse dans le tiers supérieur de l'éclairage LED latéral.



- Retirer l'éclairage LED latéral en tournant vers l'avant avec la ventouse.

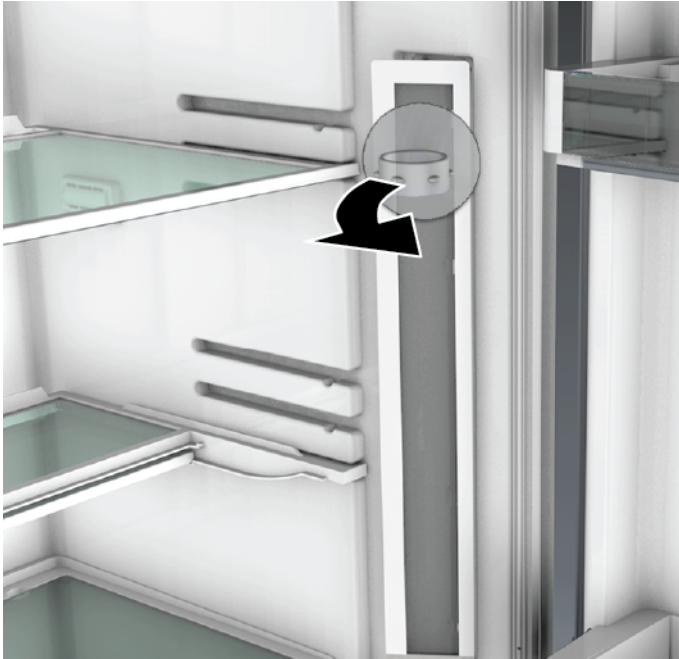



- Retirer le raccord électrique de l'éclairage LED latéral.
➡ L'éclairage LED latéral est retiré.

4.16.2 Montage de l'éclairage LED latéral

- Rétablir le raccord électrique de l'éclairage LED latéral.
 - Monter l'éclairage LED latéral sur la position correspondante contre la paroi du compartiment réfrigérateur (fixer les crochets).
- ➡ L'éclairage LED latéral est monté.

4.17 Changer le projecteur LED

Outillage nécessaire:

-  Outil spécial [00342180]
-  Tournevis plat Lame 2.4 mm x 0.4 mm x 60 mm, dans le kit [00341820]

 Votre appareil est équipé d'un éclairage LED ne demandant pas d'entretien. Les réparations de cet éclairage sont exclusivement réservées au service après-vente ou à des spécialistes autorisés!

 **DANGER**
Risque d'électrocution en raison de pièces sous tension !
Risque d'électrocution en cas de réparation non conforme

- ▶ Les pièces électriques doivent être réparées par des techniciens qualifiés.
- ▶ Après la réparation, effectuer un test de sécurité selon VDE 0701 ou les régulations spécifiques nationales.



 **DANGER**
Risque d'électrocution par des pièces conductrices de tension !
Mort par électrocution.

- ▶ Débrancher l'appareil du secteur minimum 60 secondes avant de démarrer la réparation.

 **PRUDENCE**
Arêtes vives !
Blessures par coupure

- ▶ Porter des gants de protection.

Pré-requis:

-  Appareil est déconnecté de l'alimentation.
-  La porte est ouverte.
-  Les clayettes du réfrigérateur sont retirées.

4.17.1 Démontage du projecteur LED

1. Défaire le cache du projecteur LED.

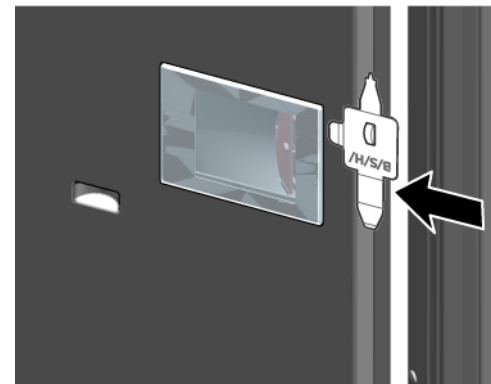

2. Tirer le cache du projecteur LED vers l'intérieur et le pousser simultanément vers l'avant.

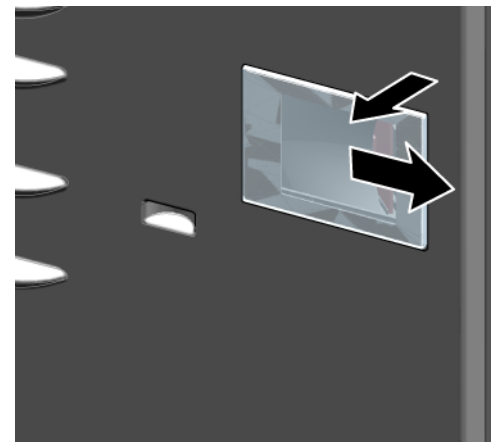

3. Défaire le module projecteur LED.

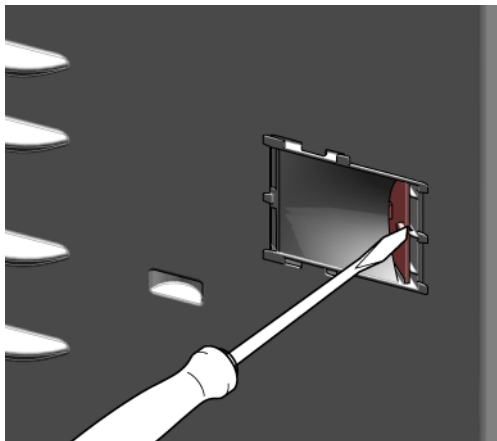

4. Défaire le raccord électrique du projecteur LED.

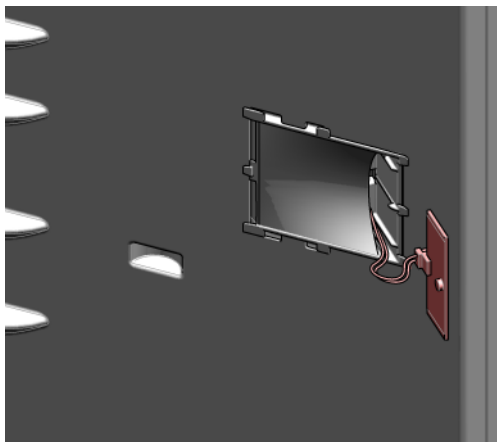





 Le projecteur LED est retiré.

4.17.2 Monter le projecteur LED

- ▶ Le montage s'effectue dans l'ordre chronologique inverse.

Reparatur Hinweise - Kühl- und Gefrierkombination

 Zu diesem Dokument	264	4.8 Austauschen der Flaschenablage	279
1.1 Wichtige Hinweise:	264	4.8.1 Ausbauen der Flaschenablage	279
1.1.1 Zweck	264	4.8.2 Einbauen der Flaschenablage	279
1.2 Zeichenerklärung.....	264	4.9 Austauschen des Türabstellers	280
1.2.1 Gefahrenstufen	264	4.9.1 Ausbauen des Türabstellers.....	280
1.2.2 Gefahrensymbole.....	264	4.9.2 Einbauen des Türabstellers.....	280
1.2.3 Struktur der Warnhinweise.....	265	4.10 Austauschen des verstellbaren Türabstellers.....	281
1.2.4 Allgemeine Symbole	265	4.10.1 Ausbauen des verstellbaren Türabstellers.....	281
 Sicherheit	266	4.10.2 Einbauen des verstellbaren Türabstellers.....	281
2.1 Allgemeine Sicherheitshinweise	266	4.11 Austauschen des Gefriergutbehälters.....	282
2.1.1 Alle Hausgeräte	266	4.11.1 Ausbauen des Gefriergutbehälters	282
 Werkzeuge und Hilfsmittel	267	4.11.2 Einbauen des Gefriergutbehälters	282
 Instandsetzen	268	4.12 Austauschen des Behälters	283
4.1 Austauschen der Türdichtung.....	268	4.12.1 Ausbauen des Behälters	283
4.1.1 Ausbauen der Türdichtung.....	268	4.12.2 Einbauen des Behälters	283
4.1.2 Einbauen der Türdichtung	268	4.13 Austauschen des ausziehbaren Behälters	284
4.2 Austauschen des Türgriffs.....	271	4.13.1 Ausbauen des ausziehbaren Behälters	284
4.2.1 Ausbauen des Türgriffs	271	4.13.2 Einbauen des ausziehbaren Behälters.....	284
4.2.2 Einbauen des Türgriffs	271	4.14 Austauschen des LED-Strahlers	285
4.3 Austauschen des oberen Türscharniers	272	4.14.1 Ausbauen des LED-Strahlers	285
4.3.1 Ausbauen des oberen Türscharniers.....	272	4.14.2 Einbauen des LED-Strahlers	285
4.3.2 Einbauen des oberen Türscharniers.....	273	4.15 Austauschen des LED-Oberlichts.....	286
4.4 Austauschen des oberen Türscharniers (Tür mit Anzeige)	274	4.15.1 Ausbauen der LED-Beleuchtung	286
4.4.1 Ausbauen des oberen Türscharniers.....	274	4.15.2 Einbauen des LED-Oberlichts	287
4.4.2 Einbauen des oberen Türscharniers.....	275	4.16 Austauschen der seitlichen LED-Beleuchtung.....	288
4.5 Austauschen des mittleren Türscharniers.....	276	4.16.1 Ausbauen der seitlichen LED-Beleuchtung.....	288
4.5.1 Ausbauen des mittleren Türscharniers	276	4.16.2 Einbauen der seitlichen LED-Beleuchtung	289
4.5.2 Einbauen des mittleren Türscharniers	276	4.17 Austauschen des LED-Strahlers	290
4.6 Austauschen des unteren Türscharniers	277	4.17.1 Ausbauen des LED-Strahlers	290
4.6.1 Ausbauen des unteren Türscharniers.....	277	4.17.2 Einbauen des LED-Strahlers	291
4.6.2 Einbauen des unteren Türscharniers.....	277		
4.7 Austauschen der Ablage	278		
4.7.1 Ausbauen der Ablage.....	278		
4.7.2 Einbauen der Ablage.....	278		

Zu diesem Dokument

1.1 Wichtige Hinweise:

1.1.1 Zweck

Diese Reparaturhinweise dienen zur Unterstützung des Kunden bei der selbständigen Geräte-Reparatur gemäß der entsprechenden Ökodesign-Richtlinie (ab 03/2021).

Sie enthalten Informationen zum Austausch bestimmter Ersatzteile sowie Warn- und Gefahrenhinweise.

Bitte wenden Sie sich in Zweifelsfällen an unseren Kundendienst. Bei nicht ordnungsgemäßer Befolgung der Reparaturhinweise ist die Schadenshaftung ausgeschlossen.

1.2 Zeichenerklärung

1.2.1 Gefahrenstufen

Die Gefahrenstufen bestehen aus einem Symbol und einem Signalwort. Das Signalwort kennzeichnet die Schwere der Gefahr.









Gefahrenstufe	Bedeutung
	Nichtbeachtung des Warnhinweises führt zu Tod oder schweren Verletzungen.
	Nichtbeachtung des Warnhinweises kann zu Tod oder schweren Verletzungen führen.
	Nichtbeachtung des Warnhinweises kann zu leichten Verletzungen führen.
	Nichtbeachtung des Warnhinweises kann zu Sachschäden führen.

Tabelle 1: Gefahrenstufen

1.2.2 Gefahrensymbole

Gefahrensymbole sind sinnbildliche Darstellungen, die einen Hinweis auf die Art der Gefahr geben.

In diesem Dokument werden folgende Gefahrensymbole verwendet:

Gefahrensymbol	Bedeutung
	Allgemeiner Warnhinweis
	Gefahr durch elektrische Spannung
	Gefahr durch Explosion
	Gefahr von Schnittverletzungen
	Gefahr von Quetschverletzungen

i Zu diesem Dokument





Gefahrensymbol	Bedeutung
	Gefahr durch heiße Oberflächen
	Gefahr durch starkes Magnetfeld
	Gefahr durch nicht ionisierende Strahlung

Tabelle 2: Gefahrensymbole

1.2.3 Struktur der Warnhinweise

Warnhinweise haben in diesem Dokument ein einheitliches Aussehen und eine einheitliche Struktur.



	<div style="background-color: red; color: white; padding: 2px; text-align: center;">⚠ GEFAHR</div> <p>Art und Quelle der Gefahr! Mögliche Folgen bei Nichtbeachtung der Gefahr / des Warnhinweises.</p> <ul style="list-style-type: none"> ▶ Maßnahmen und Verbote zur Vermeidung der Gefahr.
--	--

Das folgende Beispiel zeigt einen Warnhinweis, der vor Stromschlaggefahr durch spannungsführende Teile warnt. Die Maßnahme zur Vermeidung der Gefahr wird genannt.

	<div style="background-color: red; color: white; padding: 2px; text-align: center;">⚠ GEFAHR</div> <p>Stromschlaggefahr durch spannungsführende Teile! Tod durch Stromschlag</p> <ul style="list-style-type: none"> ▶ Gerät mindestens 60 Sekunden vor Reparaturbeginn vom Netz trennen.
--	---

1.2.4 Allgemeine Symbole

In diesem Dokument werden folgende allgemeine Symbole verwendet:

Allg. Symbol	Bedeutung
	Kennzeichnung eines besonderen (Text und/oder Grafik) Tipps
	Kennzeichnung eines einfachen (nur Text) Tipps

Allg. Symbol	Bedeutung
	Kennzeichnung eines Links zu einer Videoanleitung
	Kennzeichnung erforderlicher Werkzeuge
	Kennzeichnung erforderlicher Voraussetzungen
	Kennzeichnung einer Bedingung (Wenn ..., dann ...)
	Kennzeichnung eines Ergebnisses
[Start]	Kennzeichnung einer Taste oder Schaltfläche
[00123456]	Kennzeichnung einer Materialnummer
Status	Kennzeichnung eines angezeigten Textes / Fensters (im Gerätedisplay)

Tabelle 3: Allgemeine Symbole

2.1 Allgemeine Sicherheitshinweise

2.1.1 Alle Hausgeräte

Stromschlaggefahr durch spannungsführende Teile!

- Wenn elektrische Komponenten fehlerhaft repariert werden, besteht Stromschlaggefahr!
- Das Gerät mindestens 60 Sekunden vor Beginn der Arbeiten vom Netz trennen.
- Nach der Reparatur muss eine Sicherheitsprüfung nach VDE 0701 oder länderspezifischen Vorschriften durchgeführt werden.

Verletzungsgefahr durch scharfe Kanten!

- Schutzhandschuhe tragen.

Quetschgefahr während Reparatur-, Wartungs-, Fehlersuche- und Servicearbeiten durch schwere sich bewegende Bauteile

- Schutzhandschuhe tragen.
- Schwere Bauteile gegen Herabfallen sichern.
- Körperteile nicht in sich bewegende Bauteile stecken.





Gefährdung der Gerätesicherheit/-funktion!

- Ausschließlich Originalersatzteile verwenden.

Gefahr der Beschädigung elektrostatisch gefährdeter Bauteile (elektrostatische Entladungen)!

- Die Module, einschließlich ihrer Anschlüsse und Leiterbahnen, keinesfalls berühren.

Werkzeuge und Hilfsmittel

Bezeichnung	Details	Bilder
Schutztuch [00342013]	60 cm x 50 cm	
Schlitzschraubendreher	Klinge 2,4 mm x 0,4 mm x 60 mm, im Set [00341820]	
Spezialwerkzeug [00342180]		
Saugnapf [00342224]	Ø50 mm	
Torx-Bit TX20 [00340865]	6,3 mm (1/4")	
Schlitzschraubendreher	Klinge 10 mm x 1,6 mm x 200 mm	

4.1 Austauschen der Türdichtung

Voraussetzung:

- ✔ Die Tür ist offen.

4.1.1 Ausbauen der Türdichtung

1. Die Türdichtung aus der Kerbe in der rechten und linken Ecke lösen.

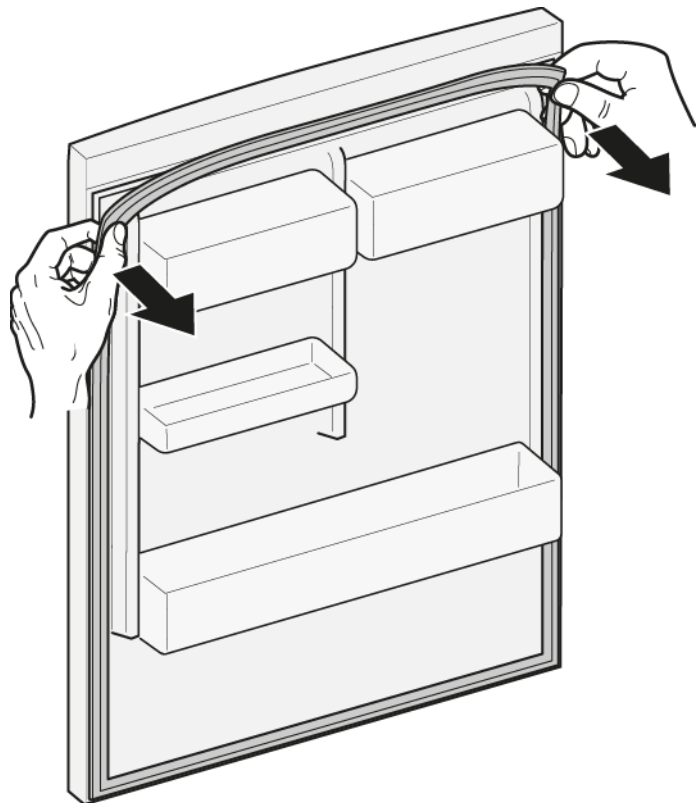

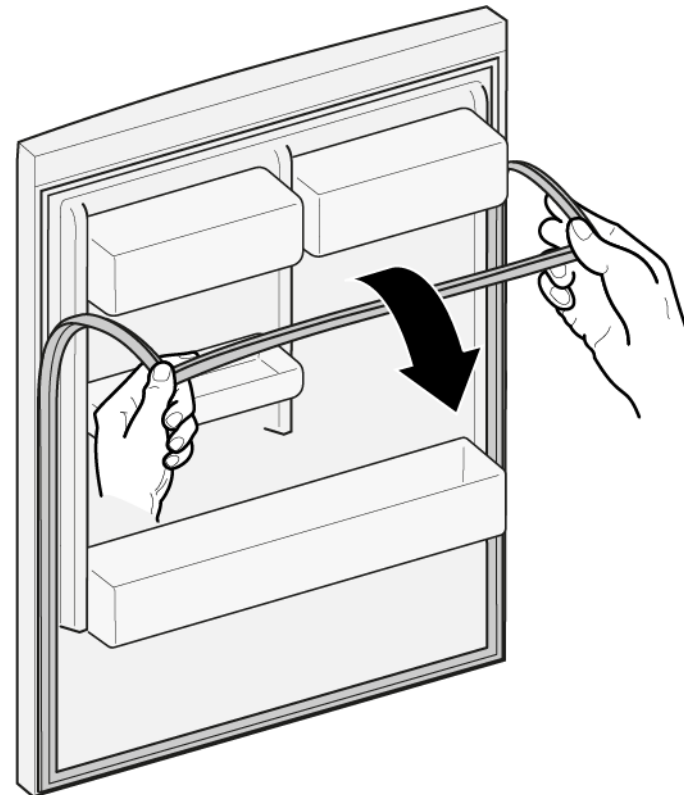

2. Die Türdichtung aus der Kerbe herausziehen.



- ➡ Die Türdichtung ist entfernt.

4.1.2 Einbauen der Türdichtung

	Die Dicke neuer Türdichtungen kann geringfügig von der Dicke alter Türdichtungen abweichen. Dies hat auf das Schließverhalten und die langfristige Funktion keinen Einfluss.
	Wenn das Gerät mit einstellbaren Scharnieren oder Scharnierbefestigungen ausgestattet ist, kann das Schließverhalten anschließend optimiert werden.
	Die kleinen seitlichen Löcher in der Türdichtung haben eine wichtige Funktion (für Lüftung erforderlich). Es handelt sich hierbei nicht um Produktionsfehler.

Instandsetzen

1. Die Dichtungskerbe auf Beschädigungen überprüfen.

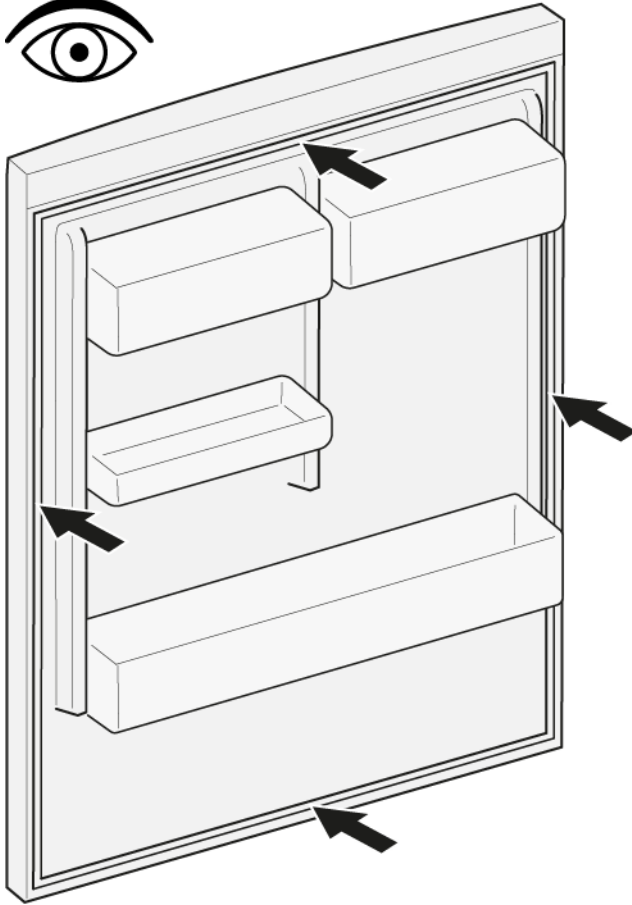

4. Die Dichtungsecken oben und unten in die Kerbe drücken.

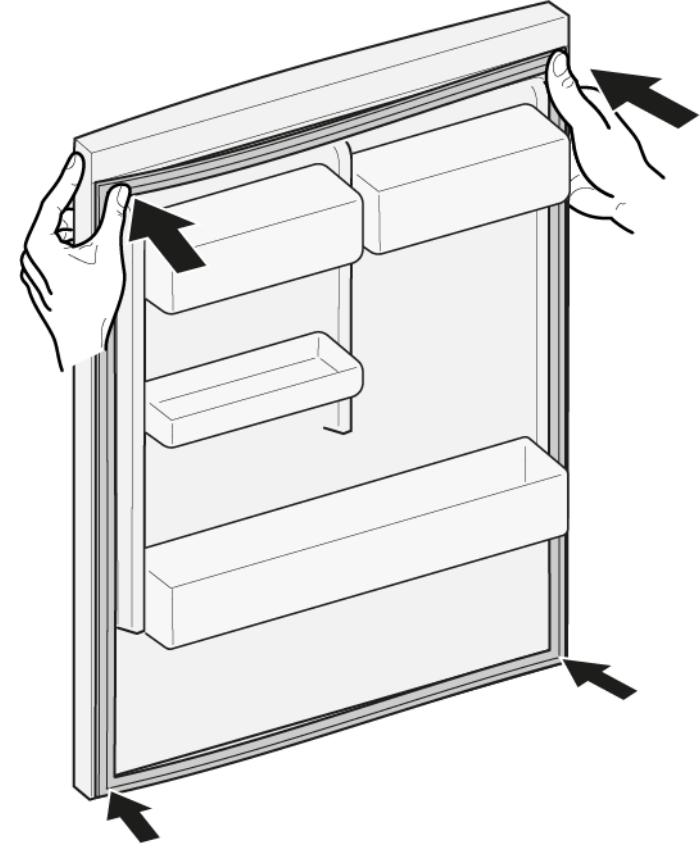

2.  Wenn die Dichtungskerbe beschädigt ist:
 - Den Kundendienst kontaktieren.

3.  Leichte Deformationen der Türdichtung sind normal und beeinträchtigen nicht die Funktion. Es wird empfohlen, die Türdichtung vor dem Einsetzen in das Gerät zu begradigen.

Die Türdichtung mit einem Haartrockner oder mit heißem Wasser erwärmen und von Hand in die richtige Form bringen.

Instandsetzen

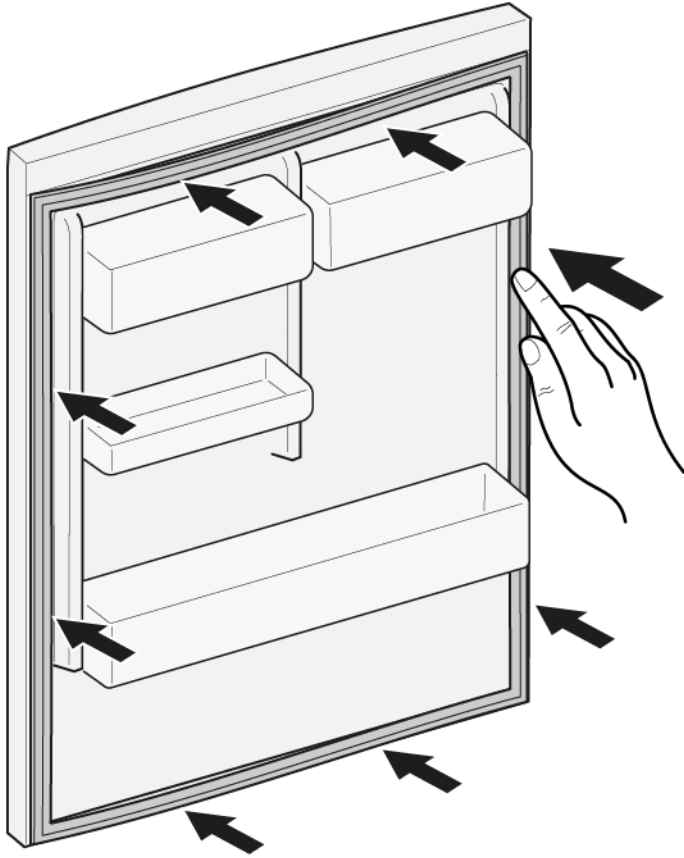

5. Die gesamte Dichtung Stück für Stück in die Kerbe drücken.





-  Die Türdichtung ist eingebaut.

4.2 Austauschen des Türgriffs

Spezielle Hilfsmittel:

-  Torx-Bit TX20 6,3 mm (1/4") [00340865]
-  Schlitzschraubendreher Klinge 10 mm x 1,6 mm x 200 mm

Voraussetzung:

-  Das Gerät ist spannungsfrei.
-  Die Tür ist offen.

4.2.1 Ausbauen des Türgriffs

- ▶ 1. Die beiden Schraubkappen entfernen (1).
- ▶ 2. Die beiden Schrauben herausschrauben (2).
- ▶ 3. Den Türgriff entfernen (3).

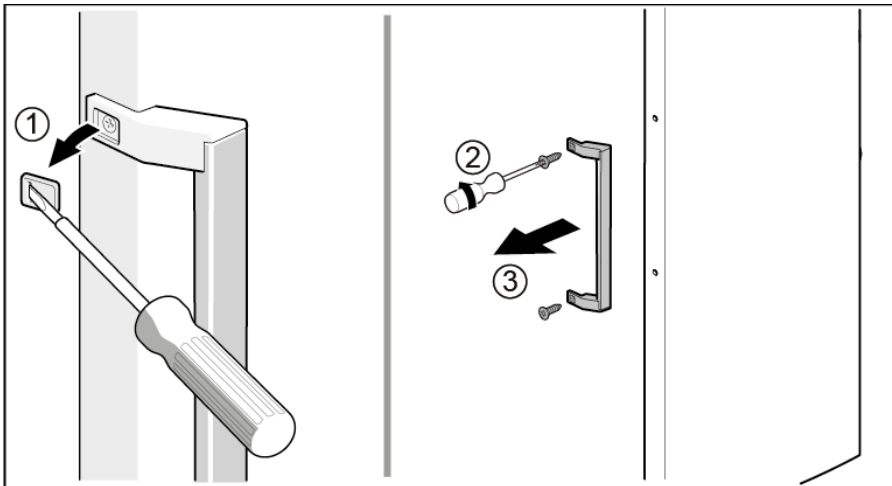

 Der Türgriff ist entfernt.



Der Türgriff für die zweite Tür kann auf die gleiche Art und Weise entfernt werden.

4.2.2 Einbauen des Türgriffs

- ▶ Der Einbau erfolgt in umgekehrter Reihenfolge.



4.3 Austauschen des oberen Türscharniers

Spezielle Hilfsmittel:

 Torx-Bit TX20 6,3 mm (1/4") [00340865]

	<p style="text-align: center;">⚠️ WARNUNG</p> <p>Schwere, unhandliche Geräte! Rücken- und Muskelverletzungen</p> <ul style="list-style-type: none"> ▶ Der Ausbau der Gerätetür sollte nur von geschulten Spezialisten durchgeführt werden. ▶ Zum Bewegen des Geräts sind zwei Personen erforderlich. ▶ Nur geeignete Werkzeuge und Vorrichtungen verwenden.
	<p style="text-align: center;">⚠️ VORSICHT</p> <p>Scharfe Kanten! Schnittverletzungen</p> <ul style="list-style-type: none"> ▶ Schutzhandschuhe tragen.
	<p style="text-align: center;">⚠️ WARNUNG</p> <p>Wegrutschen des gekippten Gerätes! Knochenbrüche / Quetschungen</p> <ul style="list-style-type: none"> ▶ Gerät gegen Wegrutschen sichern.
	<p style="text-align: center;">⚠️ VORSICHT</p> <p>Risiko herabfallender Teile durch gelöste Schrauben! Verletzungsgefahr durch herabfallende Teile.</p> <ul style="list-style-type: none"> ▶ Die Komponenten gegen Herunterfallen sichern.
	<p style="text-align: center;">⚠️ ACHTUNG</p> <p>Risiko herabfallender Teile durch gelöste Schrauben! Gefahr der Beschädigung anderer Geräteteile bzw. von Beschädigungen im Haushalt des Kunden, z. B. des Bodens.</p> <ul style="list-style-type: none"> ▶ Die Komponenten gegen Herunterfallen sichern.

Voraussetzung:

-  Das Gerät ist spannungsfrei.
-  Die Innenausstattungsteile des Geräts sind entfernt.

4.3.1 Ausbauen des oberen Türscharniers

1. Das Gerät auf die Rückseite legen.

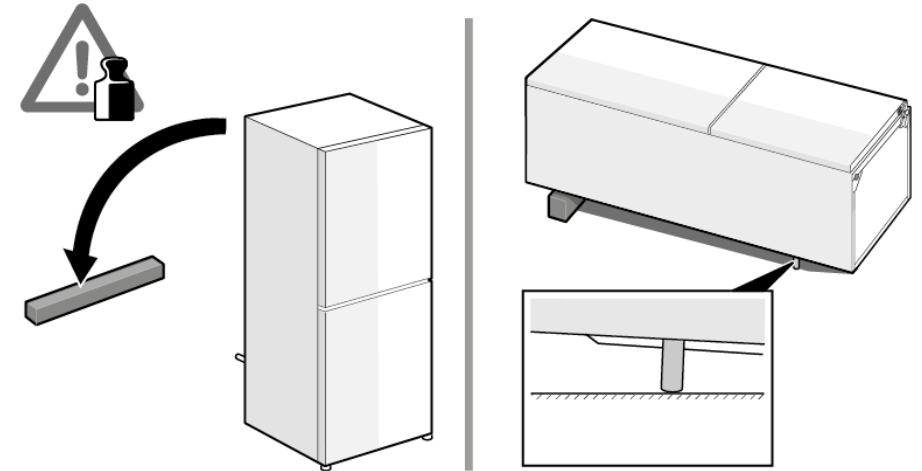

Instandsetzen

2. 1. Auf beide Seiten der oberen Scharnierabdeckung Druck ausüben (1).
2. Die obere Scharnierabdeckung abziehen (2).
3. Die Scharnierabdeckung drehen (3).
4. Die obere Scharnierabdeckung entfernen (4).
5. Die beiden Schrauben heraus-schrauben (5).
6. Das obere Scharnier entfernen (6).

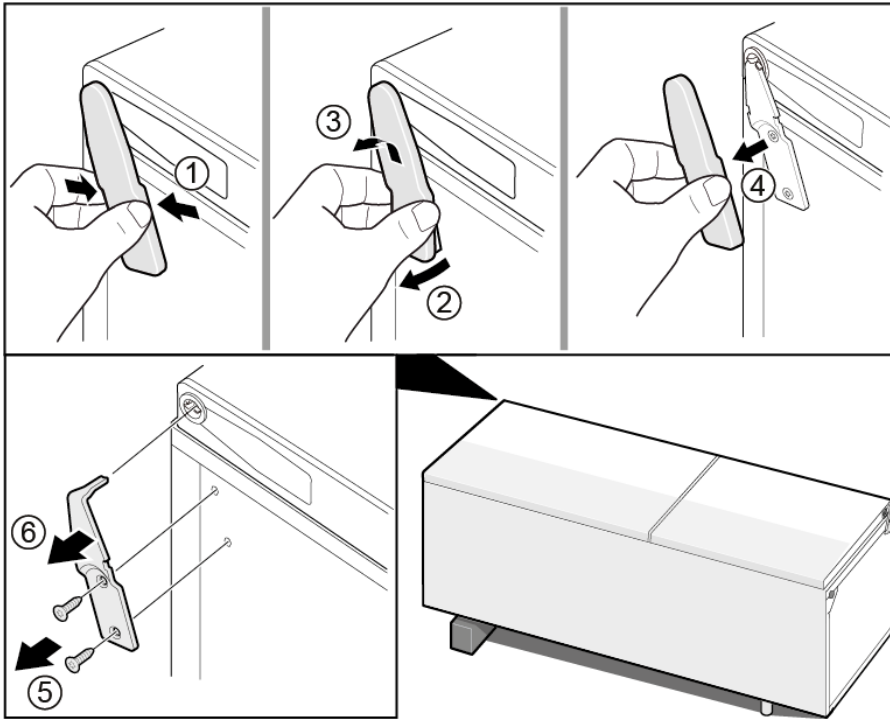

 Das obere Scharnier ist entfernt.

4.3.2 Einbauen des oberen Türscharniers

- ▶ Der Einbau erfolgt in umgekehrter Reihenfolge.

4.4 Austauschen des oberen Türscharniers (Tür mit Anzeige)

Spezielle Hilfsmittel:

🌀 Torx-Bit TX20 6,3 mm (1/4") [00340865]

	⚠️ WARNUNG
	<p>Schwere, unhandliche Geräte! Rücken- und Muskelverletzungen</p> <ul style="list-style-type: none"> ▶ Der Ausbau der Gerätetür sollte nur von geschulten Spezialisten durchgeführt werden. ▶ Zum Bewegen des Geräts sind zwei Personen erforderlich. ▶ Nur geeignete Werkzeuge und Vorrichtungen verwenden.

	⚠️ VORSICHT
	<p>Scharfe Kanten! Schnittverletzungen</p> <ul style="list-style-type: none"> ▶ Schutzhandschuhe tragen.

	⚠️ WARNUNG
	<p>Wegrutschen des gekippten Gerätes! Knochenbrüche / Quetschungen</p> <ul style="list-style-type: none"> ▶ Gerät gegen Wegrutschen sichern.

	⚠️ VORSICHT
	<p>Risiko herabfallender Teile durch gelöste Schrauben! Verletzungsgefahr durch herabfallende Teile.</p> <ul style="list-style-type: none"> ▶ Die Komponenten gegen Herunterfallen sichern.

	ACHTUNG
	<p>Risiko herabfallender Teile durch gelöste Schrauben! Gefahr der Beschädigung anderer Geräteteile bzw. von Beschädigungen im Haushalt des Kunden, z. B. des Bodens.</p> <ul style="list-style-type: none"> ▶ Die Komponenten gegen Herunterfallen sichern.

	⚠️ GEFAHR
	<p>Stromschlaggefahr durch spannungsführende Teile! Lebensgefahr durch Stromschlag bei unsachgemäßer Reparatur</p> <ul style="list-style-type: none"> ▶ Elektroteile sollten von einer Elektrofachkraft repariert werden. ▶ Nach der Reparatur muss eine Sicherheitsprüfung nach VDE 0701 oder länderspezifischen Vorschriften durchgeführt werden.

	⚠️ GEFAHR
	<p>Stromschlaggefahr durch spannungsführende Teile! Tod durch Stromschlag</p> <ul style="list-style-type: none"> ▶ Gerät mindestens 60 Sekunden vor Reparaturbeginn vom Netz trennen.

Voraussetzung:

- ✅ Das Gerät ist spannungsfrei.
- ✅ Die Innenausstattungsteile des Geräts sind entfernt.

4.4.1 Ausbauen des oberen Türscharniers

1. Das Gerät auf die Rückseite legen.

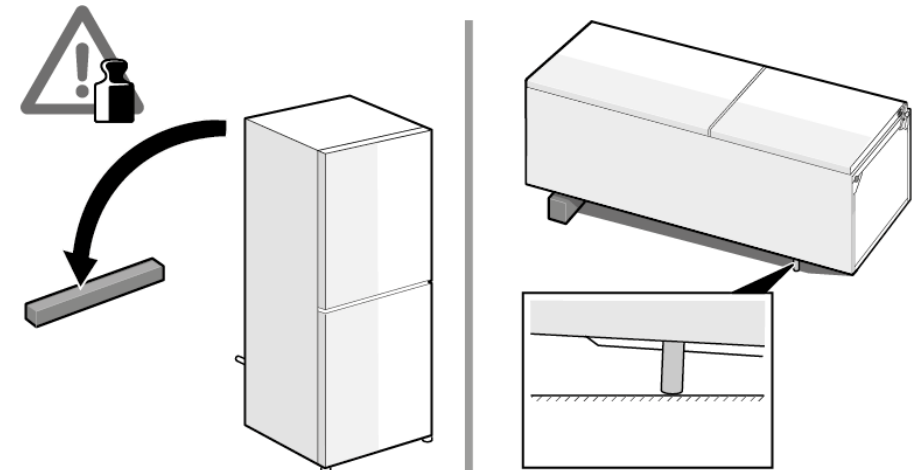

Instandsetzen

2. 1. Die obere Scharnierabdeckung entfernen (1).
2. Die Kabelboxabdeckung entfernen (2).
3. Den elektrischen Anschluss trennen (3).
4. Die Erdanschlussschraube herausschrauben (4).
5. Den Kabelschutz entfernen (5).
6. Die Schraube herausschrauben (6).

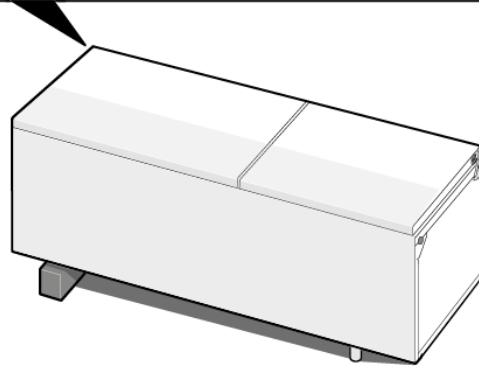
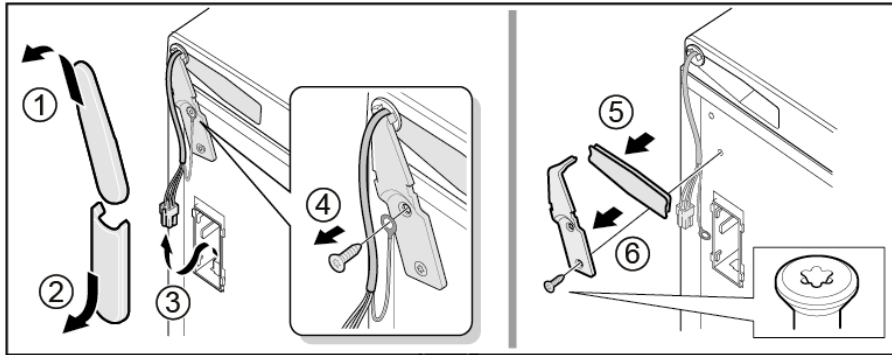

 Das obere Scharnier ist entfernt.

4.4.2 Einbauen des oberen Türscharniers

- ▶ Der Einbau erfolgt in umgekehrter Reihenfolge.

4.5 Austauschen des mittleren Türscharniers

Spezielle Hilfsmittel:

🔧 Torx-Bit TX20 6,3 mm (1/4") [00340865]

	⚠️ WARNUNG
	<p>Schwere, unhandliche Geräte! Rücken- und Muskelverletzungen</p> <ul style="list-style-type: none"> ▶ Der Ausbau der Gerätetür sollte nur von geschulten Spezialisten durchgeführt werden. ▶ Zum Bewegen des Geräts sind zwei Personen erforderlich. ▶ Nur geeignete Werkzeuge und Vorrichtungen verwenden.

	⚠️ VORSICHT
	<p>Scharfe Kanten! Schnittverletzungen</p> <ul style="list-style-type: none"> ▶ Schutzhandschuhe tragen.

	⚠️ WARNUNG
	<p>Wegrutschen des gekippten Geräts! Knochenbrüche / Quetschungen</p> <ul style="list-style-type: none"> ▶ Gerät gegen Wegrutschen sichern.

	⚠️ VORSICHT
	<p>Risiko herabfallender Teile durch gelöste Schrauben! Verletzungsgefahr durch herabfallende Teile.</p> <ul style="list-style-type: none"> ▶ Die Komponenten gegen Herunterfallen sichern.

	⚠️ ACHTUNG
	<p>Risiko herabfallender Teile durch gelöste Schrauben! Gefahr der Beschädigung anderer Geräteteile bzw. von Beschädigungen im Haushalt des Kunden, z. B. des Bodens.</p> <ul style="list-style-type: none"> ▶ Die Komponenten gegen Herunterfallen sichern.

Voraussetzung:

- ✔ Das Gerät ist spannungsfrei.
- ✔ Die Innenausstattungsstücke des Geräts sind entfernt.
- ✔ Das obere Türscharnier ist entfernt.

4.5.1 Ausbauen des mittleren Türscharniers

- ▶ 1. Die Kühlraumtür entfernen (1).
- ▶ 2. Die beiden Schrauben herausdrehen (2).
- ▶ 3. Das mittlere Scharnier entfernen (3).

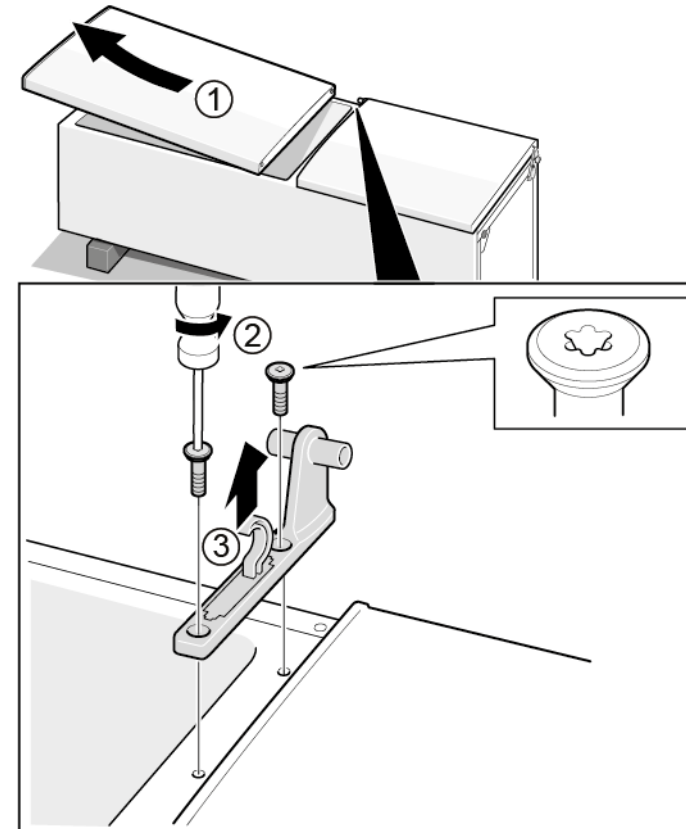

➡ Das mittlere Scharnier ist entfernt.

4.5.2 Einbauen des mittleren Türscharniers

- ▶ Der Einbau erfolgt in umgekehrter Reihenfolge.

4.6 Austauschen des unteren Türscharniers

Spezielle Hilfsmittel:

Torx-Bit TX20 6,3 mm (1/4") [00340865]

	<p style="text-align: center;">⚠️ WARNUNG</p> <p>Schwere, unhandliche Geräte! Rücken- und Muskelverletzungen</p> <ul style="list-style-type: none"> ▶ Der Ausbau der Gerätetür sollte nur von geschulten Spezialisten durchgeführt werden. ▶ Zum Bewegen des Geräts sind zwei Personen erforderlich. ▶ Nur geeignete Werkzeuge und Vorrichtungen verwenden.
	<p style="text-align: center;">⚠️ VORSICHT</p> <p>Scharfe Kanten! Schnittverletzungen</p> <ul style="list-style-type: none"> ▶ Schutzhandschuhe tragen.
	<p style="text-align: center;">⚠️ WARNUNG</p> <p>Wegrutschen des gekippten Gerätes! Knochenbrüche / Quetschungen</p> <ul style="list-style-type: none"> ▶ Gerät gegen Wegrutschen sichern.
	<p style="text-align: center;">⚠️ VORSICHT</p> <p>Risiko herabfallender Teile durch gelöste Schrauben! Verletzungsgefahr durch herabfallende Teile.</p> <ul style="list-style-type: none"> ▶ Die Komponenten gegen Herunterfallen sichern.
	<p style="text-align: center;">⚠️ ACHTUNG</p> <p>Risiko herabfallender Teile durch gelöste Schrauben! Gefahr der Beschädigung anderer Geräteteile bzw. von Beschädigungen im Haushalt des Kunden, z. B. des Bodens.</p> <ul style="list-style-type: none"> ▶ Die Komponenten gegen Herunterfallen sichern.

Voraussetzung:

- ✔ Das Gerät ist spannungsfrei.
- ✔ Die Innenausstattungsstücke des Geräts sind entfernt.
- ✔ Das obere Scharnier ist entfernt.

- ✔ Das mittlere Scharnier ist entfernt.

4.6.1 Ausbauen des unteren Türscharniers

- ▶ 1. Die Gefrierraumtür entfernen (1).
- ▶ 2. Die Schraube herausschrauben (2).
- ▶ 3. Das untere Scharnier nach außen drehen (3).
- ▶ 4. Das untere Scharnier entfernen (4).

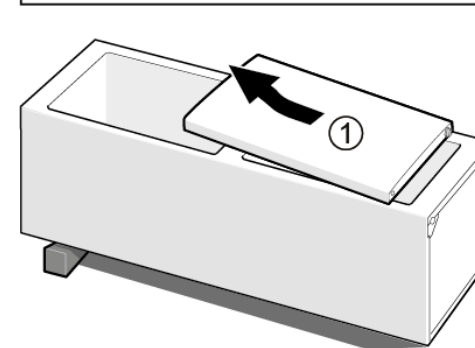
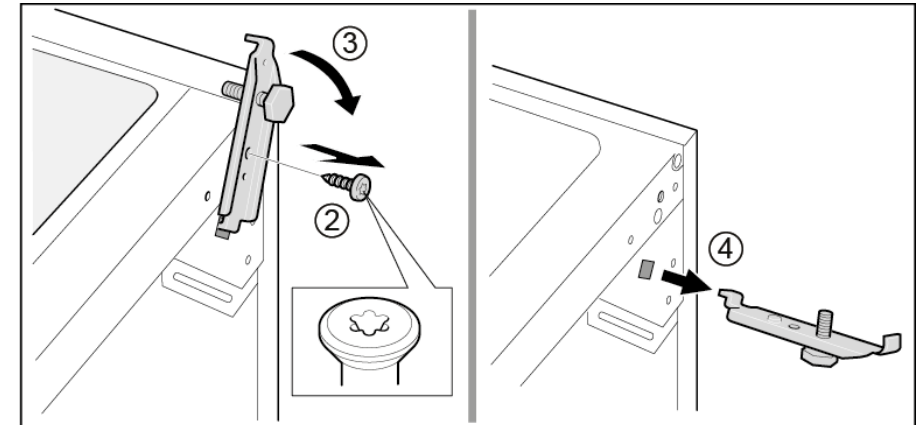

- ➡ Das untere Türscharnier ist entfernt.

4.6.2 Einbauen des unteren Türscharniers

- ▶ Der Einbau erfolgt in umgekehrter Reihenfolge.

4.7 Austauschen der Ablage

Voraussetzung:

- ✔ Die Tür ist offen.

4.7.1 Ausbauen der Ablage

- ▶ Die Ablage herausziehen.

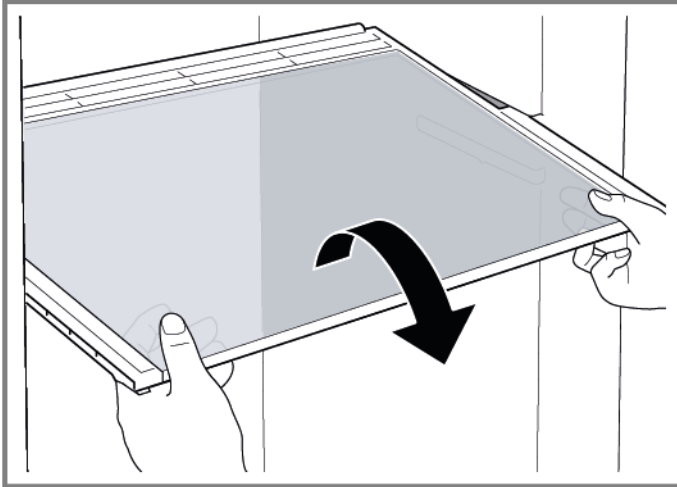

- ➡ Die Ablage ist entfernt.

4.7.2 Einbauen der Ablage

- ▶ Der Einbau erfolgt in umgekehrter Reihenfolge.

4.8 Austauschen der Flaschenablage

Voraussetzung:

- ✔ Die Tür ist offen.

4.8.1 Ausbauen der Flaschenablage

- ▶ Die Flaschenablage herausziehen.

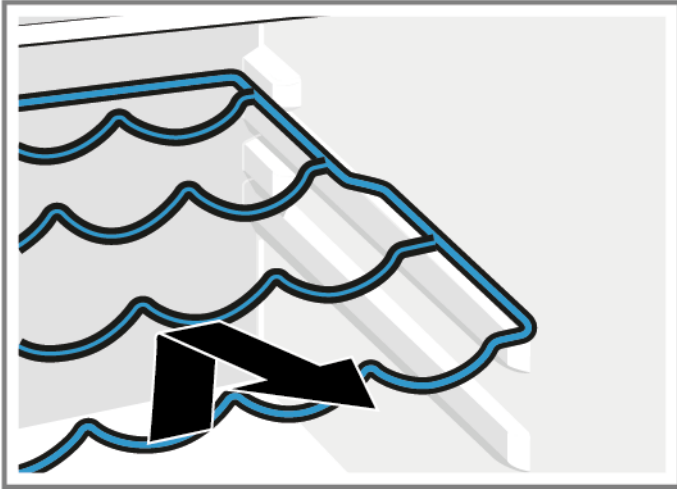

- ➡ Die Flaschenablage ist entfernt.

4.8.2 Einbauen der Flaschenablage

- ▶ Der Einbau erfolgt in umgekehrter Reihenfolge.

4.9 Austauschen des Türabstellers

Voraussetzung:

- ✔ Die Tür ist offen.

4.9.1 Ausbauen des Türabstellers

- ▶ Den Türabsteller anheben.

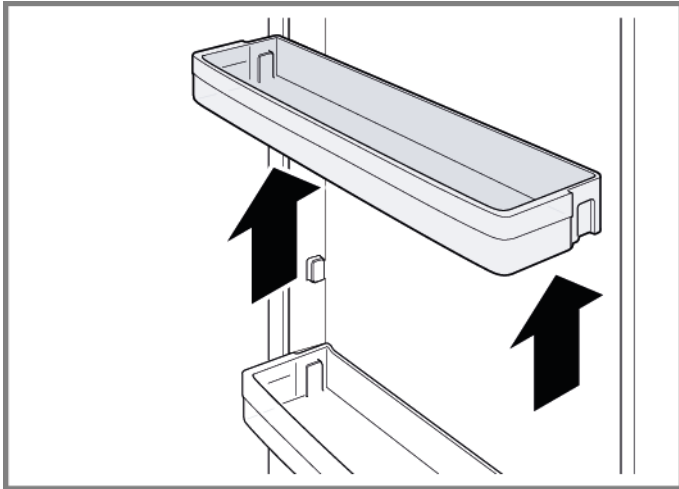

- ➡ Der Türabsteller ist entfernt.

4.9.2 Einbauen des Türabstellers

- ▶ Der Einbau erfolgt in umgekehrter Reihenfolge.

4.10 Austauschen des verstellbaren Türabstellers

Voraussetzung:

- ✔ Die Tür ist offen.

4.10.1 Ausbauen des verstellbaren Türabstellers

- ▶ Den höhenverstellbaren Türabsteller nach oben bewegen, bis er sich aus der Halterung löst.

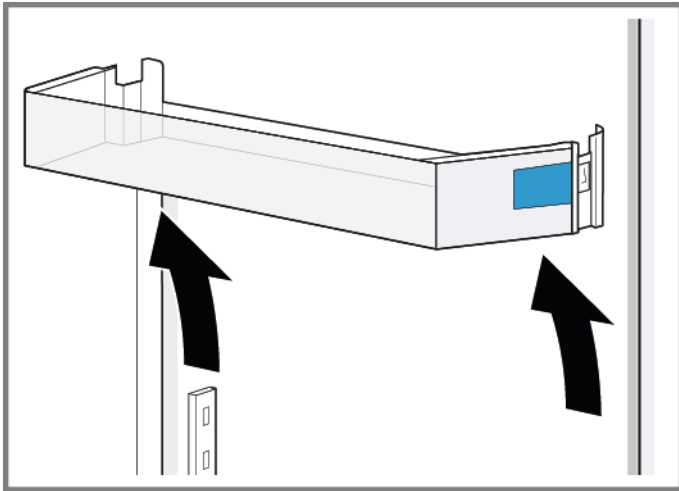

- ➡ Der verstellbare Türabsteller ist entfernt.

4.10.2 Einbauen des verstellbaren Türabstellers

- ▶ Der Einbau erfolgt in umgekehrter Reihenfolge.

4.11 Austauschen des Gefriergutbehälters

Voraussetzung:

- ✔ Die Tür ist offen.

4.11.1 Ausbauen des Gefriergutbehälters

- ▶ 1. Den Gefriergutbehälter vollständig herausziehen (1).
- ▶ 2. Den Gefriergutbehälter entfernen (2).

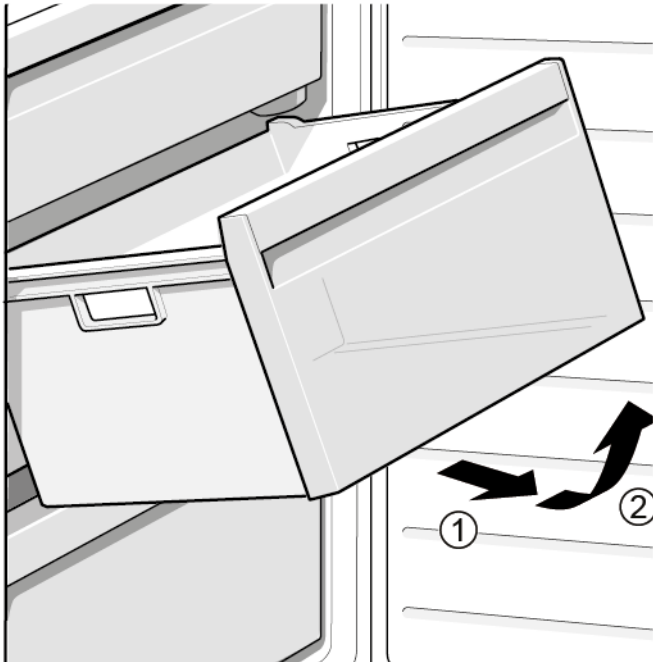

- ➡ Der Gefriergutbehälter ist entfernt.

4.11.2 Einbauen des Gefriergutbehälters

- ▶ Der Einbau erfolgt in umgekehrter Reihenfolge.

4.12 Austauschen des Behälters

Voraussetzung:

- ✔ Die Tür ist offen.

4.12.1 Ausbauen des Behälters

- ▶ 1. Den unteren Kühlschrankbehälter entnehmen (1).
- ▶ 2. Den oberen Kühlschrankbehälter entnehmen (2).

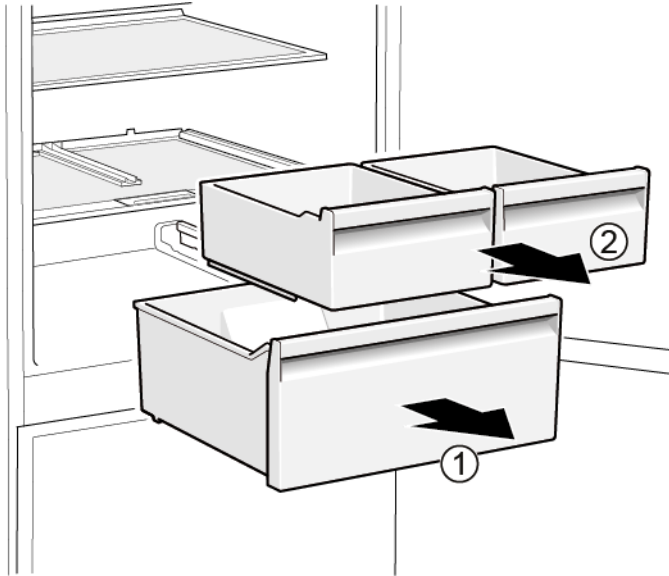

- ➡ Die Behälter sind entfernt.

4.12.2 Einbauen des Behälters

- ▶ Der Einbau erfolgt in umgekehrter Reihenfolge.

4.13 Austauschen des ausziehbaren Behälters

Voraussetzung:

- ✔ Die Tür ist offen.

4.13.1 Ausbauen des ausziehbaren Behälters

- ▶ 1. Den ausziehbaren Behälter vollständig herausziehen (1).
- ▶ 2. Den ausziehbaren Behälter entfernen (2).

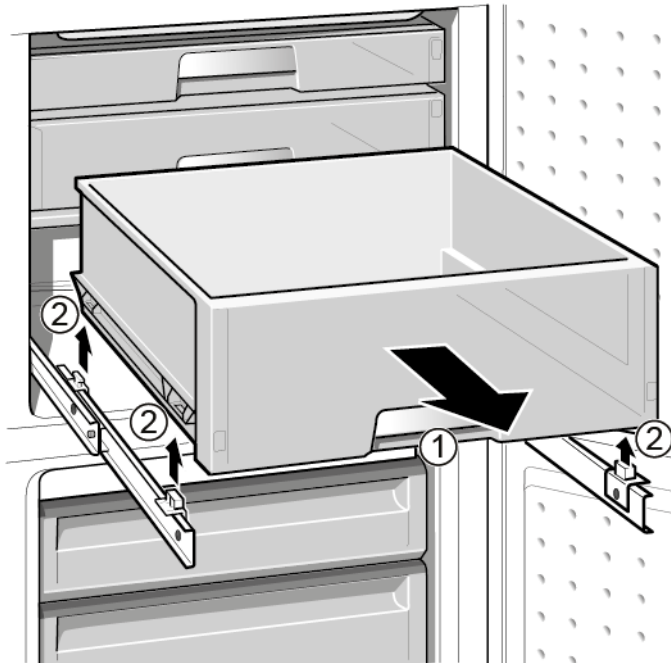

- ➡ Der ausziehbare Behälter ist entfernt.

4.13.2 Einbauen des ausziehbaren Behälters

- ▶ Der Einbau erfolgt in umgekehrter Reihenfolge.

4.14 Austauschen des LED-Strahlers

Spezielle Hilfsmittel:

 Spezialwerkzeug [00342180]

 Ihr Gerät ist mit einer wartungsfreien LED-Beleuchtung ausgestattet. Reparaturen an dieser Beleuchtung dürfen nur vom Kundendienst oder von autorisierten Fachkräften ausgeführt werden!

 **GEFAHR**
Stromschlaggefahr durch spannungsführende Teile!
 Lebensgefahr durch Stromschlag bei unsachgemäßer Reparatur

- ▶ Elektroteile sollten von einer Elektrofachkraft repariert werden.
- ▶ Nach der Reparatur muss eine Sicherheitsprüfung nach VDE 0701 oder länderspezifischen Vorschriften durchgeführt werden.



 **GEFAHR**
Stromschlaggefahr durch spannungsführende Teile!
 Tod durch Stromschlag

- ▶ Gerät mindestens 60 Sekunden vor Reparaturbeginn vom Netz trennen.

 **VORSICHT**
Scharfe Kanten!
 Schnittverletzungen

- ▶ Schutzhandschuhe tragen.

Voraussetzung:

-  Das Gerät ist spannungsfrei.
-  Die Tür ist offen.

4.14.1 Ausbauen des LED-Strahlers

- Den LED-Strahler mithilfe von Spezialwerkzeug herausziehen (1).

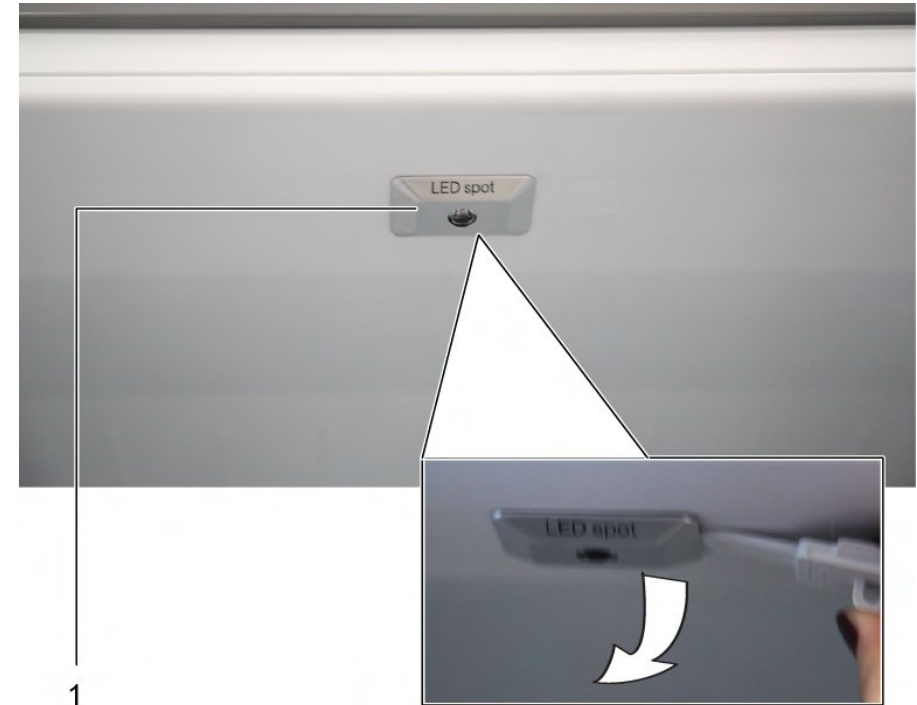

- Die elektrischen Anschlüsse des LED-Strahlers abziehen.
-  Der LED-Strahler ist entfernt.

4.14.2 Einbauen des LED-Strahlers

- ▶ Der Einbau erfolgt in umgekehrter Reihenfolge.

4.15 Austauschen des LED-Oberlichts

Spezielle Hilfsmittel:

-  Schlitzschraubendreher Klinge 2,4 mm x 0,4 mm x 60 mm, im Set [00341820]



	Ihr Gerät ist mit einer wartungsfreien LED-Beleuchtung ausgestattet. Reparaturen an dieser Beleuchtung dürfen nur vom Kundendienst oder von autorisierten Fachkräften ausgeführt werden!
---	--

	⚠ GEFAHR
	Stromschlaggefahr durch spannungsführende Teile! Lebensgefahr durch Stromschlag bei unsachgemäßer Reparatur <ul style="list-style-type: none"> ▶ Elektroteile sollten von eine Elektrofachkraft repariert werden. ▶ Nach der Reparatur muss eine Sicherheitsprüfung nach VDE 0701 oder länderspezifischen Vorschriften durchgeführt werden.

	⚠ GEFAHR
	Stromschlaggefahr durch spannungsführende Teile! Tod durch Stromschlag <ul style="list-style-type: none"> ▶ Gerät mindestens 60 Sekunden vor Reparaturbeginn vom Netz trennen.

	⚠ VORSICHT
	Scharfe Kanten! Schnittverletzungen <ul style="list-style-type: none"> ▶ Schutzhandschuhe tragen.

Voraussetzung:

-  Das Gerät ist spannungsfrei.
-  Die Tür ist offen.
-  Die oberen Innenausstattungsteile sind entfernt.

4.15.1 Ausbauen der LED-Beleuchtung

- Die LED-Beleuchtung nach links schieben.

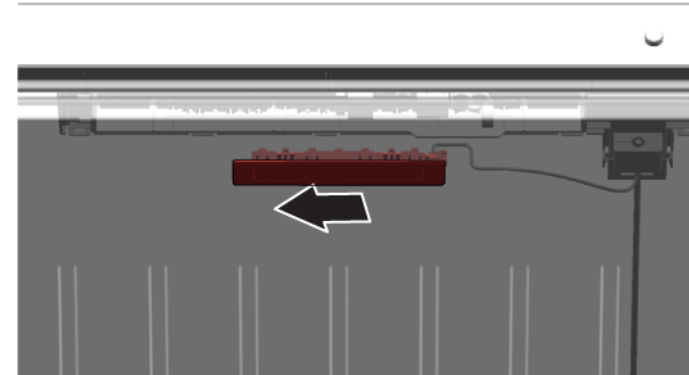

-  Der elektrische Anschluss der LED-Beleuchtung ist getrennt.

- Die Haken der LED-Beleuchtung lösen.

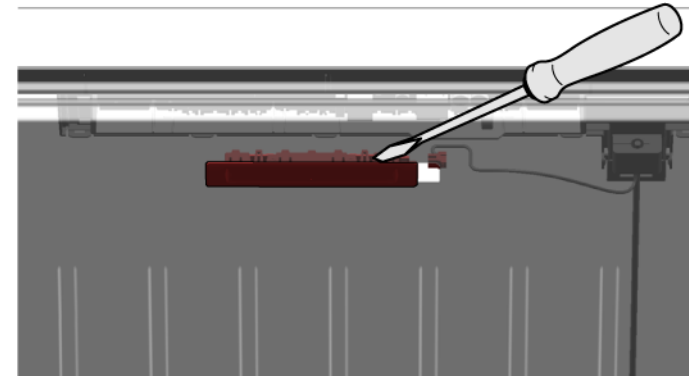

3. Die LED-Beleuchtung nach vorn entnehmen.

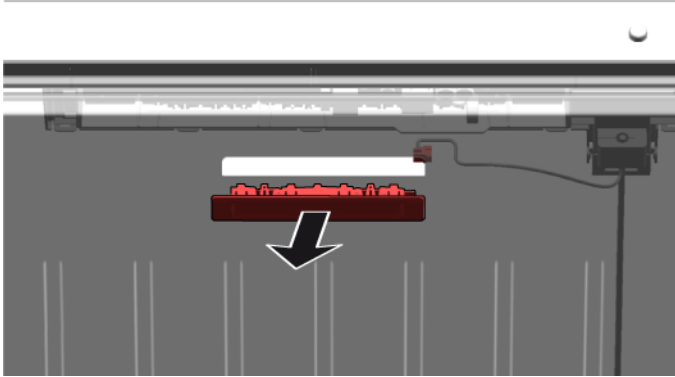

- ➡ Die LED-Beleuchtung ist entfernt.

4.15.2 Einbauen des LED-Oberlichts

- ▶ Der Einbau erfolgt in umgekehrter Reihenfolge.

4.16 Austauschen der seitlichen LED-Beleuchtung

Spezielle Hilfsmittel:

 Saugnapf Ø50 mm [00342224]



Ihr Gerät ist mit einer wartungsfreien LED-Beleuchtung ausgestattet. Reparaturen an dieser Beleuchtung dürfen nur vom Kundendienst oder von autorisierten Fachkräften ausgeführt werden!



GEFAHR

Stromschlaggefahr durch spannungsführende Teile!

Lebensgefahr durch Stromschlag bei unsachgemäßer Reparatur

- ▶ Elektroteile sollten von einer Elektrofachkraft repariert werden.
- ▶ Nach der Reparatur muss eine Sicherheitsprüfung nach VDE 0701 oder länderspezifischen Vorschriften durchgeführt werden.



GEFAHR

Stromschlaggefahr durch spannungsführende Teile!

Tod durch Stromschlag

- ▶ Gerät mindestens 60 Sekunden vor Reparaturbeginn vom Netz trennen.



VORSICHT

Scharfe Kanten!

Schnittverletzungen

- ▶ Schutzhandschuhe tragen.

Voraussetzung:

- ✔ Das Gerät ist spannungsfrei.
- ✔ Die Tür ist offen.
- ✔ Die Kühlraumablagen sind entfernt.

4.16.1 Ausbauen der seitlichen LED-Beleuchtung

1. Den Saugnapf im oberen Drittel der seitlichen LED-Beleuchtung befestigen.



Instandsetzen

- Die seitliche LED-Beleuchtung mit dem Saugnapf in einer Drehbewegung nach vorn abziehen.

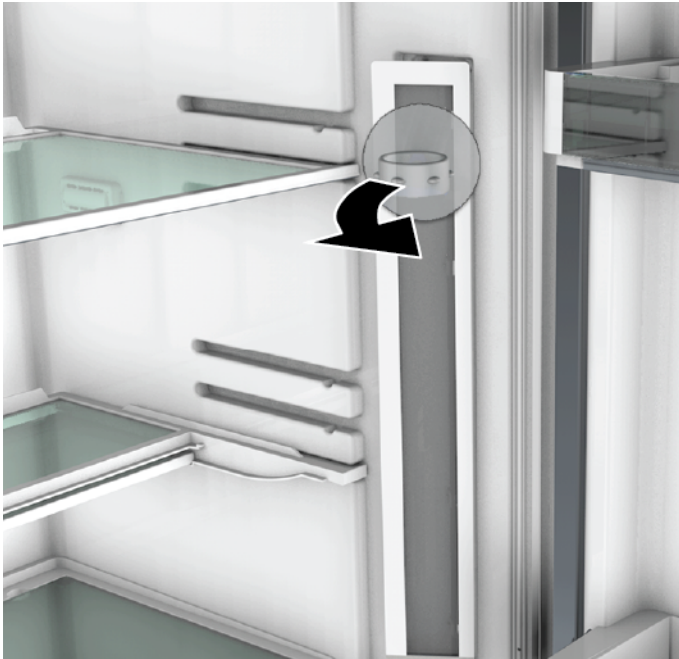

- Den elektrischen Anschluss der seitlichen LED-Beleuchtung trennen.
➡ Die seitliche LED-Beleuchtung ist entfernt.

4.16.2 Einbauen der seitlichen LED-Beleuchtung

- Den elektrischen Anschluss der seitlichen LED-Beleuchtung herstellen.
 - Die seitliche LED-Beleuchtung an der entsprechenden Position an der Kühlraumwand montieren (Haken einrasten).
- ➡ Die seitliche LED-Beleuchtung ist eingebaut.

4.17 Austauschen des LED-Strahlers

Spezielle Hilfsmittel:

- 🔧 Spezialwerkzeug [00342180]
- 🔧 Schlitzschraubendreher Klinge 2,4 mm x 0,4 mm x 60 mm, im Set [00341820]

i Ihr Gerät ist mit einer wartungsfreien LED-Beleuchtung ausgestattet. Reparaturen an dieser Beleuchtung dürfen nur vom Kundendienst oder von autorisierten Fachkräften ausgeführt werden!

⚠️ GEFAHR
Stromschlaggefahr durch spannungsführende Teile!
 Lebensgefahr durch Stromschlag bei unsachgemäßer Reparatur

- ▶ Elektroteile sollten von einer Elektrofachkraft repariert werden.
- ▶ Nach der Reparatur muss eine Sicherheitsprüfung nach VDE 0701 oder länderspezifischen Vorschriften durchgeführt werden.

⚠️ GEFAHR
Stromschlaggefahr durch spannungsführende Teile!
 Tod durch Stromschlag

- ▶ Gerät mindestens 60 Sekunden vor Reparaturbeginn vom Netz trennen.

⚠️ VORSICHT
Scharfe Kanten!
 Schnittverletzungen

- ▶ Schutzhandschuhe tragen.

Voraussetzung:

- ✅ Das Gerät ist spannungsfrei.
- ✅ Die Tür ist offen.
- ✅ Die Kühlraumablagen sind entfernt.

4.17.1 Ausbauen des LED-Strahlers

1. Die Abdeckung des LED-Strahlers lösen.

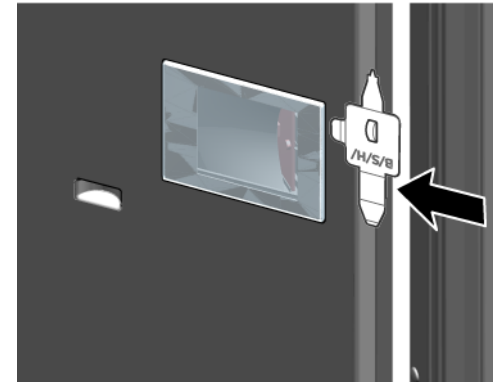

2. Die Abdeckung des LED-Strahlers nach innen ziehen und gleichzeitig nach vorn schieben.

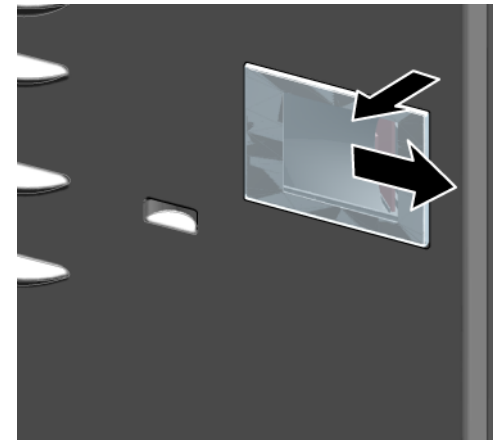

- Das LED-Strahler-Modul lösen.

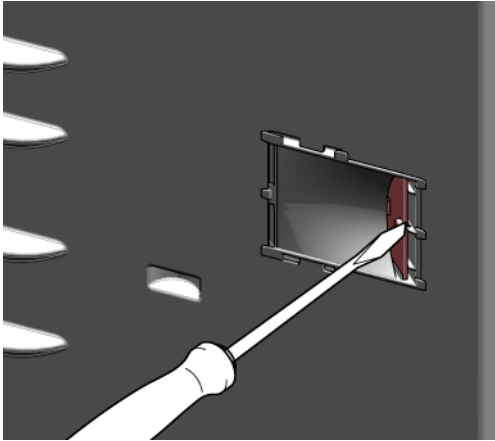

- Den elektrischen Anschluss des LED-Strahlers trennen.

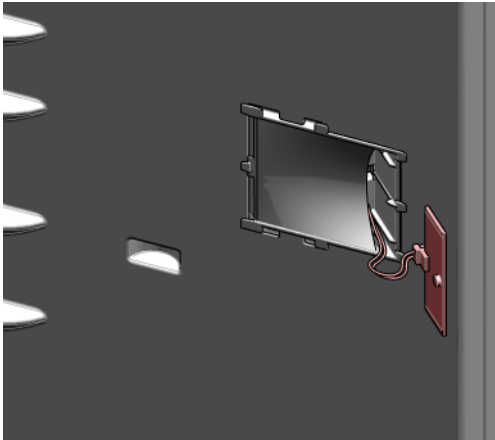





- Der LED-Strahler ist entfernt.

4.17.2 Einbauen des LED-Strahlers

- Der Einbau erfolgt in umgekehrter Reihenfolge.

Υποδείξεις επισκευής - Ψυγειοκαταψύκτης

 Σχετικά με αυτό το έγγραφο	293
1.1 Σημαντικές πληροφορίες.....	293
1.1.1 Σκοπός.....	293
1.2 Επεξήγηση συμβόλων.....	293
1.2.1 Επίπεδα κινδύνου.....	293
1.2.2 Σύμβολα κινδύνου.....	293
1.2.3 Δομή των προειδοποιήσεων.....	294
1.2.4 Γενικά σύμβολα.....	294
 Ασφάλεια	295
2.1 Γενικές οδηγίες ασφαλείας.....	295
2.1.1 Όλες οι οικιακές συσκευές.....	295
 Εργαλεία και βοηθήματα	296
 Επισκευή	297
4.1 Αντικατάσταση στεγανοποιητικού πόρτας.....	297
4.1.1 Αφαίρεση στεγανοποιητικού πόρτας.....	297
4.1.2 Τοποθέτηση στεγανοποιητικού πόρτας.....	297
4.2 Αντικατάσταση λαβής πόρτας.....	300
4.2.1 Αφαίρεση λαβής πόρτας.....	300
4.2.2 Τοποθέτηση λαβής πόρτας.....	300
4.3 Αντικατάσταση επάνω μεντεσέ πόρτας.....	301
4.3.1 Αφαίρεση επάνω μεντεσέ πόρτας.....	301
4.3.2 Τοποθέτηση επάνω μεντεσέ πόρτας.....	302
4.4 Αντικατάσταση επάνω μεντεσέ πόρτας (πόρτα με οθόνη).....	303
4.4.1 Αφαίρεση επάνω μεντεσέ πόρτας.....	303
4.4.2 Τοποθέτηση επάνω μεντεσέ πόρτας.....	304
4.5 Αντικατάσταση μεσαίου μεντεσέ πόρτας.....	305
4.5.1 Αφαίρεση μεσαίου μεντεσέ πόρτας.....	305
4.5.2 Τοποθέτηση μεσαίου μεντεσέ πόρτας.....	305
4.6 Αντικατάσταση κάτω μεντεσέ πόρτας.....	306
4.6.1 Αφαίρεση κάτω μεντεσέ πόρτας.....	306
4.6.2 Τοποθέτηση κάτω μεντεσέ πόρτας.....	306
4.7 Αντικατάσταση ραφιού.....	307
4.7.1 Αφαίρεση ραφιού.....	307
4.7.2 Τοποθέτηση ραφιού.....	307

4.8 Αντικατάσταση επιφάνειας εναπόθεσης φιαλών.....	308
4.8.1 Αφαίρεση επιφάνειας εναπόθεσης φιαλών.....	308
4.8.2 Τοποθέτηση επιφάνειας εναπόθεσης φιαλών.....	308
4.9 Αντικατάσταση ραφιού πόρτας.....	309
4.9.1 Αφαίρεση ραφιού πόρτας.....	309
4.9.2 Τοποθέτηση ραφιού πόρτας.....	309
4.10 Αντικατάσταση ραφιού πόρτας με δυνατότητα ρύθμισης.....	310
4.10.1 Αφαίρεση ραφιού πόρτας με δυνατότητα ρύθμισης.....	310
4.10.2 Τοποθέτηση ραφιού πόρτας με δυνατότητα ρύθμισης.....	310
4.11 Αντικατάσταση συρταριού κατεψυγμένων τροφίμων.....	311
4.11.1 Αφαίρεση συρταριού κατεψυγμένων τροφίμων.....	311
4.11.2 Τοποθέτηση συρταριού κατεψυγμένων τροφίμων.....	311
4.12 Αντικατάσταση συρταριού.....	312
4.12.1 Αφαίρεση συρταριού.....	312
4.12.2 Τοποθέτηση συρταριού.....	312
4.13 Αντικατάσταση τηλεσκοπικού συρταριού.....	313
4.13.1 Αφαίρεση τηλεσκοπικού συρταριού.....	313
4.13.2 Τοποθέτηση τηλεσκοπικού συρταριού.....	313
4.14 Αντικατάσταση spot φωτισμού LED.....	314
4.14.1 Αφαίρεση spot φωτισμού LED.....	314
4.14.2 Τοποθέτηση spot φωτισμού LED.....	314
4.15 Αντικατάσταση επάνω φωτός LED.....	315
4.15.1 Αφαίρεση φωτός LED.....	315
4.15.2 Τοποθέτηση επάνω φωτισμού LED.....	316
4.16 Αντικατάσταση πλευρικής ράβδου φωτισμού LED.....	317
4.16.1 Αφαίρεση πλευρικής ράβδου φωτισμού LED.....	317
4.16.2 Τοποθέτηση πλευρικής ράβδου φωτισμού LED.....	318
4.17 Αντικατάσταση προβολέα LED.....	319
4.17.1 Αφαίρεση spot φωτισμού LED.....	319
4.17.2 Τοποθέτηση spot φωτισμού LED.....	320

i Σχετικά με αυτό το έγγραφο

1.1 Σημαντικές πληροφορίες

1.1.1 Σκοπός

Αυτές οι συμβουλές επισκευών υποστηρίζουν τους καταναλωτές στην επισκευή των συσκευών από τους ίδιους, σύμφωνα με τον ισχύοντα κανονισμό οικολογικού σχεδιασμού (από τις 03/2021).

Περιέχουν πληροφορίες για την αντικατάσταση ορισμένων ανταλλακτικών, συμπεριλαμβανομένων προειδοποιήσεων και κινδύνων.

Σε περίπτωση ερωτήσεων, επικοινωνήστε με το τμήμα εξυπηρέτησης πελατών της εταιρείας μας. Φέρουμε ευθύνη για τις ζημιές εάν οι συμβουλές επισκευής έχουν ακολουθηθεί σωστά.

1.2 Επεξήγηση συμβόλων

1.2.1 Επίπεδα κινδύνου

Τα επίπεδα προειδοποίησης ασφάλειας αποτελούνται από ένα σύμβολο και μια λέξη. Η λέξη προειδοποίησης προσδιορίζει τη σοβαρότητα του κινδύνου.





Επίπεδο προειδοποίησης	Σημασία
 ΚΙΝΔΥΝΟΣ	Η μη τήρηση του προειδοποιητικού μηνύματος θα οδηγήσει σε θάνατο ή σε σοβαρούς τραυματισμούς.
 ΠΡΟΕΙΔΟΠΟΙΗΣΗ	Η μη τήρηση του προειδοποιητικού μηνύματος θα μπορούσε να οδηγήσει σε θάνατο ή σε σοβαρούς τραυματισμούς.
 ΠΡΟΣΟΧΗ	Η μη τήρηση του προειδοποιητικού μηνύματος θα μπορούσε να οδηγήσει σε μικρούς τραυματισμούς.
 ΠΡΟΣΟΧΗ!	Η μη τήρηση του προειδοποιητικού μηνύματος θα μπορούσε να οδηγήσει σε υλικές ζημιές της ιδιοκτησίας.

Πίνακας 1: Επίπεδα κινδύνου





1.2.2 Σύμβολα κινδύνου

Τα σύμβολα κινδύνου είναι συμβολικές αναπαραστάσεις που δίνουν μια ένδειξη για το είδος του κινδύνου.

Τα ακόλουθα σύμβολα κινδύνου χρησιμοποιούνται στο παρόν έγγραφο:

Σύμβολο κινδύνου	Σημασία
	Γενικό προειδοποιητικό μήνυμα
	Κίνδυνος από ηλεκτρική τάση
	Κίνδυνος έκρηξης
	Κίνδυνος κοψίματος

i Σχετικά με αυτό το έγγραφο

Σύμβολο κινδύνου	Σημασία
	Κίνδυνος σύνθλιψης
	Κίνδυνος από καυτές επιφάνειες
	Κίνδυνος από ισχυρό μαγνητικό πεδίο
	Κίνδυνος από μη ιονίζουσα ακτινοβολία

Πίνακας 2: Σύμβολα κινδύνου

1.2.3 Δομή των προειδοποιήσεων

.Οι προειδοποιήσεις σε αυτό το έγγραφο έχουν μια τυποποιημένη εμφάνιση και μια τυποποιημένη δομή.

	<div style="background-color: red; color: white; padding: 2px; text-align: center;">⚠ ΚΙΝΔΥΝΟΣ</div> <p>Είδος και πηγή κινδύνου! Πιθανές συνέπειες εάν αγνοήσετε τον κίνδυνο/την προειδοποίηση. ▶ Μέτρα και απαγορεύσεις για την πρόληψη του κινδύνου.</p>
--	--

Το παρακάτω παράδειγμα δείχνει μια προειδοποίηση που προειδοποιεί κατά της ηλεκτροπληξίας λόγω ηλεκτροφόρων μερών. Αναφέρεται το μέτρο για την αποφυγή του κινδύνου.

	<div style="background-color: red; color: white; padding: 2px; text-align: center;">⚠ ΚΙΝΔΥΝΟΣ</div> <p>Κίνδυνος ηλεκτροπληξίας λόγω ηλεκτροφόρων μερών! Θάνατος από ηλεκτροπληξία ▶ Αποσυνδέετε τις συσκευές από την παροχή ηλεκτρικού ρεύματος τουλάχιστον 60 δευτερόλεπτα πριν ξεκινήσετε τις επισκευές.</p>
--	---

1.2.4 Γενικά σύμβολα

Τα ακόλουθα γενικά σύμβολα χρησιμοποιούνται στο παρόν έγγραφο:

Γεν. σύμβολο	Σημασία
	Ταυτοποίηση μιας ειδικής συμβουλής (κειμένου ή/και γραφικών)
	Ταυτοποίηση μιας ειδικής συμβουλής (μόνο κειμένου)
	Ταυτοποίηση συνδέσμου ή εκπαιδευτικού βίντεο
	Ταυτοποίηση απαραίτητων εργαλείων
	Ταυτοποίηση απαραίτητων προϋποθέσεων
	Ταυτοποίηση μιας συνθήκης (αν ..., κατόπιν ...)
	Ταυτοποίηση αποτελέσματος
	Ταυτοποίηση ενός πλήκτρου ή κουμπιού
[00123456]	Ταυτοποίηση ενός κωδικού ανταλλακτικού
Κατάσταση	Ταυτοποίηση εμφανιζόμενου κειμένου/ παραθύρου (στην οθόνη της συσκευής)

Πίνακας 3: Γενικά σύμβολα

2.1 Γενικές οδηγίες ασφαλείας

2.1.1 Όλες οι οικιακές συσκευές

Κίνδυνος ηλεκτροπληξίας λόγω ηλεκτροφόρων μερών!

- Τα σφάλματα από επισκευές σε ηλεκτρικά εξαρτήματα μπορεί να προκαλέσουν ηλεκτροπληξία!
- Αποσυνδέστε τη συσκευή από την πρίζα για τουλάχιστον 60 δευτερόλεπτα πριν από την έναρξη των εργασιών.
- Μετά την επισκευή πραγματοποιήστε έλεγχο ασφαλείας σύμφωνα με το VDE 0701 ή κανονισμούς της συγκεκριμένης χώρας.

Κίνδυνος τραυματισμού από κοφτερές άκρες!

- Φοράτε προστατευτικά γάντια.

Κίνδυνος σύνθλιψης κατά την επισκευή, συντήρηση, αντιμετώπιση προβλημάτων και το σέρβις από βαριά και κινούμενα μέρη

- Φοράτε προστατευτικά υποδήματα.
- Ασφαλίστε τα βαριά μέρη από πτώση.
- Μην προσαρτάτε μέρη του πλαισίου στα κινούμενα μέρη.





Κίνδυνος για την ασφάλεια/τη λειτουργία της συσκευής!

- Χρησιμοποιείτε μόνο γνήσια ανταλλακτικά.

Κίνδυνος πρόκλησης βλάβης σε μέρη ευαίσθητα στον στατικό ηλεκτρισμό (ESDs)!

- Μην αγγίζετε τις μονάδες, συμπεριλαμβανομένων των συνδέσεων και των αγωγών των πλακετών.

Εργαλεία και βοηθήματα

Όνομασία	Λεπτομέριες	Εικόνες
Πανάκι προστασίας [00342013]	60 cm x 50 cm	
Πλακέ κατσαβίδι	Λεπίδα 2,4 mm x 0,4 mm x 60 mm, στο κιτ [00341820]	
Ειδικό εργαλείο [00342180]		
Βεντούζα [00342224]	Ø50 mm	
Μύτη Torx TX20 [00340865]	6,3 mm (1/4")	
Πλακέ κατσαβίδι	Λεπίδα 10 mm x 1,6 mm x 200 mm	

4.1 Αντικατάσταση στεγανοποιητικού πόρτας

Προϋπόθεση:

- ✔ Η πόρτα είναι ανοιχτή.

4.1.1 Αφαίρεση στεγανοποιητικού πόρτας

1. Απελευθερώστε το στεγανοποιητικό πόρτας από την εγκοπή στη δεξιά και αριστερή γωνία.

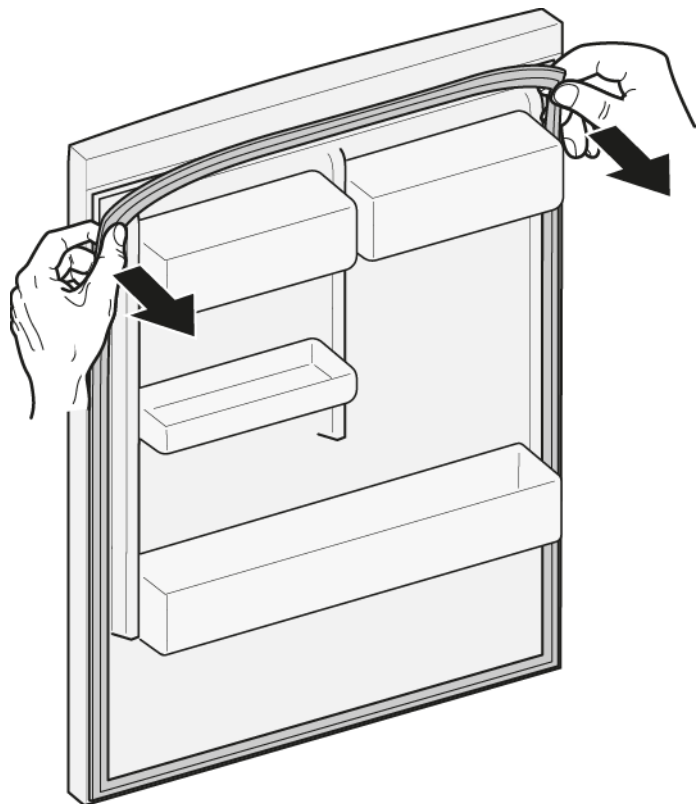



2. Τραβήξτε το στεγανοποιητικό πόρτας έξω από την εγκοπή.



- ➡ Το στεγανοποιητικό της πόρτας έχει αφαιρεθεί.

4.1.2 Τοποθέτηση στεγανοποιητικού πόρτας

	Το πάχος του νέου στεγανοποιητικού πόρτας μπορεί να αποκλίνει ελαφρώς από το πάχος του παλαιού στεγανοποιητικού πόρτας. Αυτό δεν θα επηρεάσει τη συμπεριφορά κλεισίματος και τη μακροπρόθεσμη λειτουργία.
	Εάν η συσκευή σας έχει προσαρμοζόμενους μεντεσέδες ή προσαρτήματα μεντεσέ, μπορεί να βελτιστοποιήσετε τη συμπεριφορά κλεισίματος αργότερα.
	Οι μικρές οπές πλευρικά στο στεγανοποιητικό της πόρτας είναι λειτουργικές (απαραίτητες για τον αερισμό). Δεν είναι κατασκευαστικά ελαττώματα.

1. Ελέγξτε την εγκοπή για το στεγανοποιητικό για ζημιές.

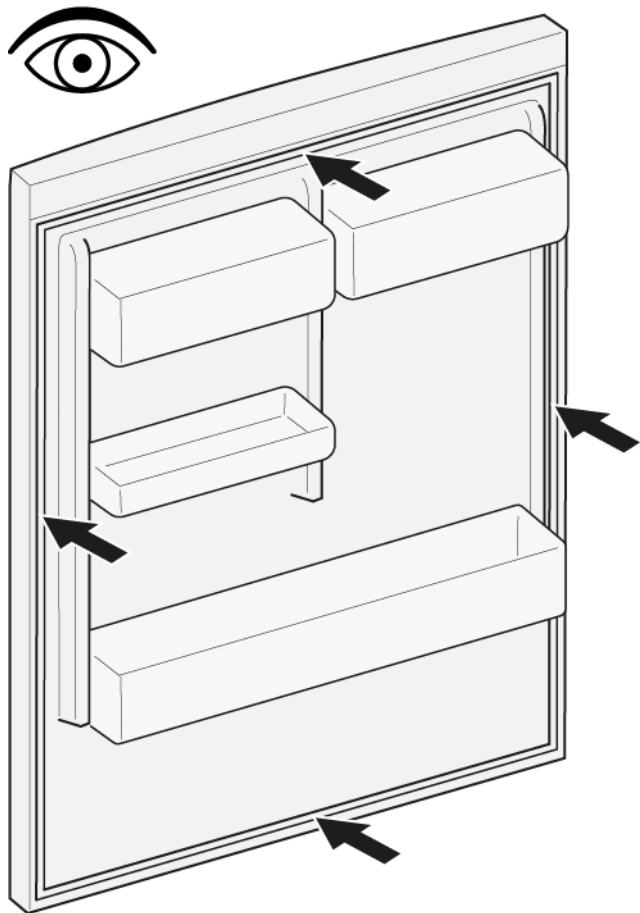

4. Πιέστε τις γωνίες του στεγανοποιητικού επάνω και κάτω στην εγκοπή.

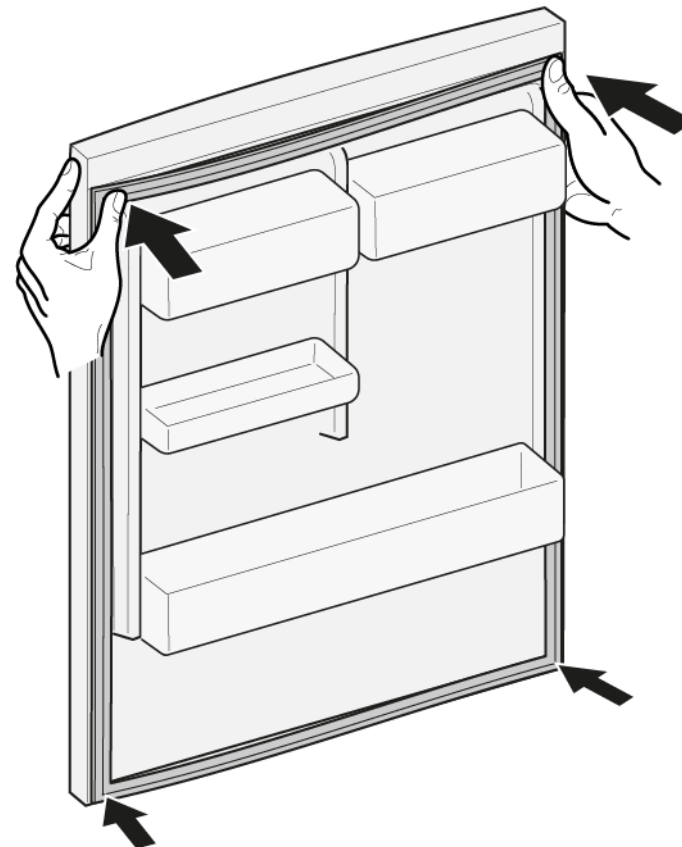



2.  Εάν η εγκοπή για στεγανοποιητικό είναι κατεστραμμένη.
- Επικοινωνήστε με την εξυπηρέτηση πελατών.

3.  Η ελαφριά παραμόρφωση του στεγανοποιητικού της πόρτας είναι φυσιολογική και δεν επηρεάζει τη λειτουργία της. Συνιστάται να ισιώνετε το στεγανοποιητικό της πόρτας πριν την τοποθετήσετε στη συσκευή.

Θερμάνετε το στεγανοποιητικό της πόρτας με πιστολάκι ή ζεστό νερό και αλλάξτε το σχήμα του με το χέρι.

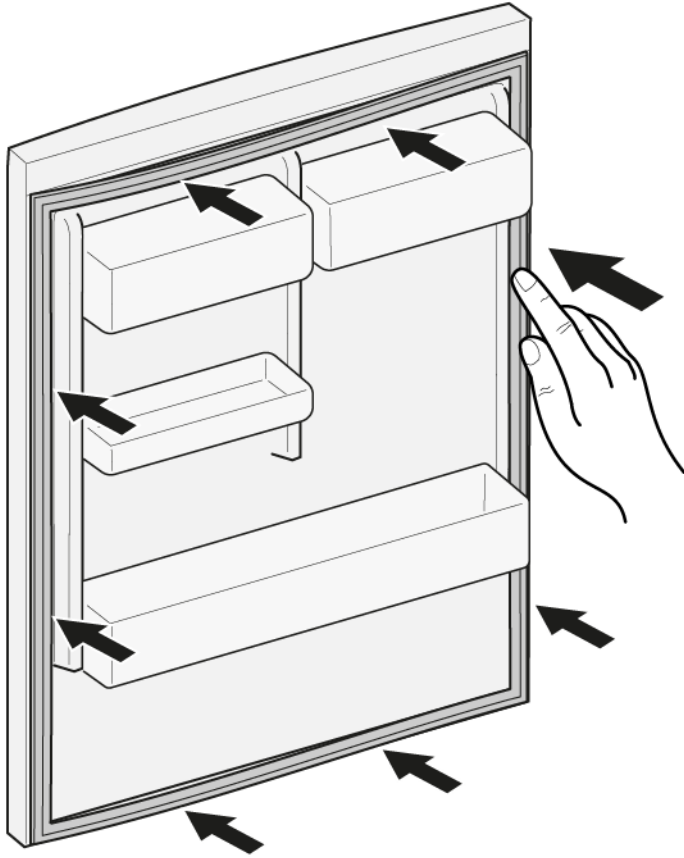
5. Πιέστε ολόκληρο το στεγανοποιητικό βήμα βήμα στο εσωτερικό της εγκοπής.



-  Το στεγανοποιητικό της πόρτας τοποθετήθηκε.

4.2 Αντικατάσταση λαβής πόρτας

Ειδικά βοηθητικά μέσα:

- Μύτη Torx TX20 6,3 mm (1/4") [00340865]
- Πλακέ κατσαβίδι Λεπίδα 10 mm x 1,6 mm x 200 mm

Προϋπόθεση:

- ✓ Η συσκευή είναι αποσυνδεδεμένη από την παροχή τροφοδοσίας.
- ✓ Η πόρτα είναι ανοιχτή.

4.2.1 Αφαίρεση λαβής πόρτας

- 1. Αφαιρέστε τα δύο πώματα βίδας (1).
- 2. Ξεβιδώστε δύο βίδες (2).
- 3. Αφαιρέστε τη λαβή της πόρτας (3).

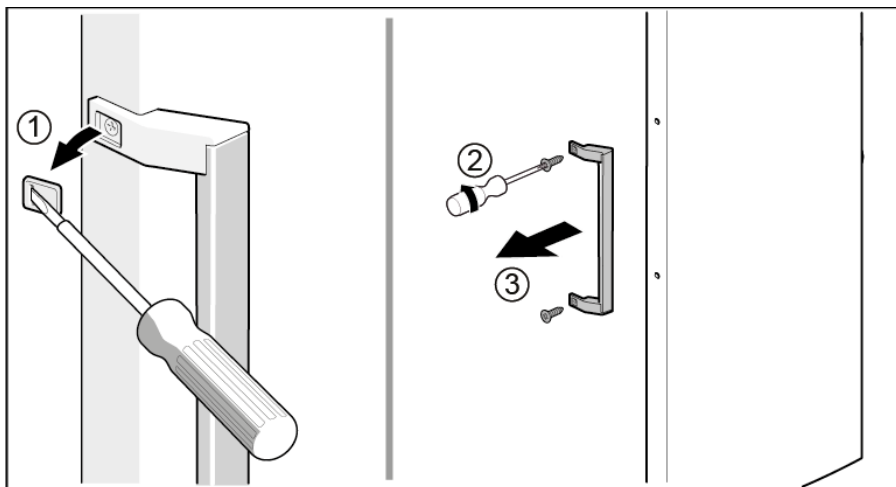

➔ Η λαβή της πόρτας έχει αφαιρεθεί.



Η λαβή πόρτας για τη δεύτερη πόρτα μπορεί να αφαιρεθεί με τον ίδιο τρόπο.

4.2.2 Τοποθέτηση λαβής πόρτας

- ▶ Εγκαταστήστε με την αντίθετη σειρά.

4.3 Αντικατάσταση επάνω μεντεσέ πόρτας

Ειδικά βοηθητικά μέσα:

 Μύτη Torx TX20 6,3 mm (1/4") [00340865]

	<p style="text-align: center;">⚠ ΠΡΟΕΙΔΟΠΟΙΗΣΗ</p> <p>Βαριές, ογκώδεις συσκευές! Τραυματισμοί μέσης και μυών</p> <ul style="list-style-type: none"> ▶ Η διαδικασία αφαίρεσης της πόρτας της συσκευής πρέπει να εκτελείται μόνο από εκπαιδευμένους ειδικούς. ▶ Η μετακίνηση της συσκευής πρέπει να εκτελείται από δύο άτομα. ▶ Χρησιμοποιείτε μόνο κατάλληλα εργαλεία και εξοπλισμό.
--	--



	<p style="text-align: center;">⚠ ΠΡΟΣΟΧΗ</p> <p>Αιχμηρές ακμές! Τραυματισμοί από κοπή</p> <ul style="list-style-type: none"> ▶ Φοράτε προστατευτικά γάντια.
--	--

	<p style="text-align: center;">⚠ ΠΡΟΕΙΔΟΠΟΙΗΣΗ</p> <p>Ολίσθηση κεκλιμένων συσκευών! Κατάγματα οστών/τραυματισμοί σύνθλιψης</p> <ul style="list-style-type: none"> ▶ Ασφαλίστε τις συσκευές από ολίσθηση.
--	---

	<p style="text-align: center;">⚠ ΠΡΟΣΟΧΗ</p> <p>Κίνδυνοι από πτώση μερών εξαιτίας χαλαρών βιδών! Τραυματισμός εξαιτίας πτώσης τμημάτων.</p> <ul style="list-style-type: none"> ▶ Ασφαλίστε τα εξαρτήματα από πτώση.
---	--

	<p style="text-align: center;">ΠΡΟΣΟΧΗ!</p> <p>Κίνδυνων από πτώση εξαρτημάτων εξαιτίας χαλαρών βιδών! Ζημιά σε άλλα μέρη της συσκευής ή στην οικία του πελάτη, π.χ. δάπεδο.</p> <ul style="list-style-type: none"> ▶ Ασφαλίστε τα εξαρτήματα από πτώση.
--	--

Προϋπόθεση:

-  Η συσκευή είναι αποσυνδεδεμένη από την παροχή τροφοδοσίας.
-  Αφαιρούνται τα εσωτερικά εξαρτήματα συσκευής.

4.3.1 Αφαίρεση επάνω μεντεσέ πόρτας

1. Τοποθετήστε τη συσκευή στην πίσω πλευρά.

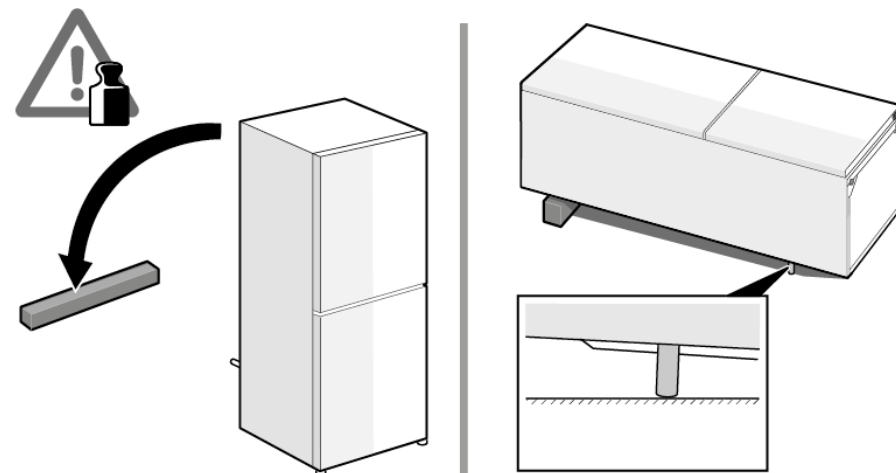

2. 1. Πιέστε το επάνω κάλυμμα μεντεσέ και στις δύο πλευρές (1).
2. Μετακινήστε και αφαιρέστε το κάλυμμα επάνω μεντεσέ (2).
3. Περιστρέψτε το κάλυμμα μεντεσέ (3).
4. Αφαιρέστε το κάλυμμα επάνω μεντεσέ (4).
5. Ξεβιδώστε δύο βίδες (5).
6. Αφαιρέστε τον επάνω μεντεσέ (6).

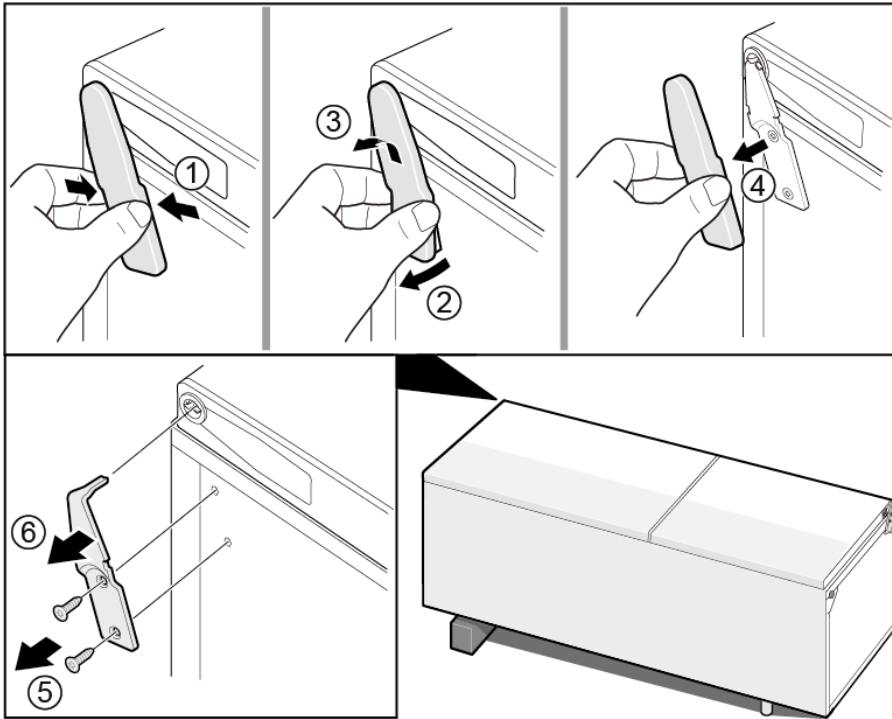

 Ο επάνω μεντεσές έχει αφαιρεθεί.

4.3.2 Τοποθέτηση επάνω μεντεσέ πόρτας

- ▶ Εγκαταστήστε με την αντίθετη σειρά.

4.4 Αντικατάσταση επάνω μεντεσέ πόρτας (πόρτα με θόνη)

Ειδικά βοηθητικά μέσα:

 Μύτη Torx TX20 6,3 mm (1/4") [00340865]

	⚠ ΠΡΟΕΙΔΟΠΟΙΗΣΗ
	<p>Βαριές, ογκώδεις συσκευές! Τραυματισμοί μέσης και μυών</p> <ul style="list-style-type: none"> ▶ Η διαδικασία αφαίρεσης της πόρτας της συσκευής πρέπει να εκτελείται μόνο από εκπαιδευμένους ειδικούς. ▶ Η μετακίνηση της συσκευής πρέπει να εκτελείται από δύο άτομα. ▶ Χρησιμοποιείτε μόνο κατάλληλα εργαλεία και εξοπλισμό.

	⚠ ΠΡΟΣΟΧΗ
	<p>Αιχμηρές ακμές! Τραυματισμοί από κοπή</p> <ul style="list-style-type: none"> ▶ Φοράτε προστατευτικά γάντια.

	⚠ ΠΡΟΕΙΔΟΠΟΙΗΣΗ
	<p>Ολίσθηση κεκλιμένων συσκευών! Κατάγματα οστών/τραυματισμοί σύνθλιψης</p> <ul style="list-style-type: none"> ▶ Ασφαλίστε τις συσκευές από ολίσθηση.



	⚠ ΠΡΟΣΟΧΗ
	<p>Κίνδυνοι από πτώση μερών εξαιτίας χαλαρών βιδών! Τραυματισμός εξαιτίας πτώσης τμημάτων.</p> <ul style="list-style-type: none"> ▶ Ασφαλίστε τα εξαρτήματα από πτώση.

	ΠΡΟΣΟΧΗ!
	<p>Κίνδυνων από πτώση εξαρτημάτων εξαιτίας χαλαρών βιδών! Ζημιά σε άλλα μέρη της συσκευής ή στην οικία του πελάτη, π.χ. δάπεδο.</p> <ul style="list-style-type: none"> ▶ Ασφαλίστε τα εξαρτήματα από πτώση.

	⚠ ΚΙΝΔΥΝΟΣ
	<p>Κίνδυνος ηλεκτροπληξίας λόγω ηλεκτροφόρων μερών! Κίνδυνος για τη ζωή από ηλεκτροπληξία σε περίπτωση ακατάλληλης επισκευής</p> <ul style="list-style-type: none"> ▶ Τα ηλεκτρικά μέρη πρέπει να επισκευάζονται από εκπαιδευμένους ηλεκτρολόγους. ▶ Μετά την επισκευή πραγματοποιήστε έλεγχο ασφάλειας σύμφωνα με το VDE 0701 ή κανονισμούς της συγκεκριμένης χώρας.

	⚠ ΚΙΝΔΥΝΟΣ
	<p>Κίνδυνος ηλεκτροπληξίας λόγω ηλεκτροφόρων μερών! Θάνατος από ηλεκτροπληξία</p> <ul style="list-style-type: none"> ▶ Αποσυνδέετε τις συσκευές από την παροχή ηλεκτρικού ρεύματος τουλάχιστον 60 δευτερόλεπτα πριν ξεκινήσετε τις επισκευές.

Προϋπόθεση:

-  Η συσκευή είναι αποσυνδεδεμένη από την παροχή τροφοδοσίας.
-  Αφαιρούνται τα εσωτερικά εξαρτήματα συσκευής.

4.4.1 Αφαίρεση επάνω μεντεσέ πόρτας

1. Τοποθετήστε τη συσκευή στην πίσω πλευρά.

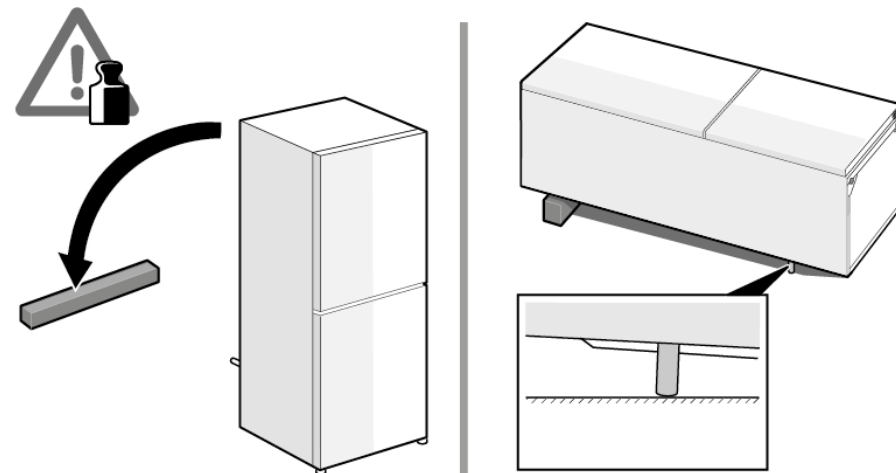

2. 1. Αφαιρέστε το κάλυμμα επάνω μεντεσέ (1).
2. Αφαιρέστε το κάλυμμα του κουτιού καλωδίων (2).
3. Αποσυνδέστε την ηλεκτρική σύνδεση (3).
4. Ξεβιδώστε τη βίδα σύνδεσης γείωσης (4).
5. Αφαιρέστε την προστασία καλωδίων (5).
6. Ξεβιδώστε τη βίδα (6).

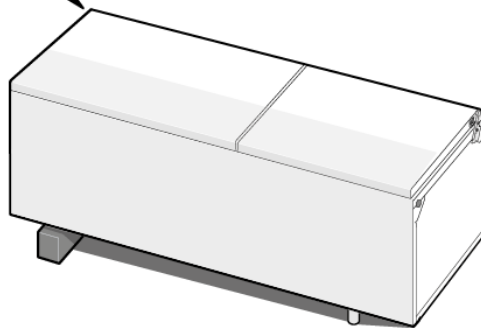
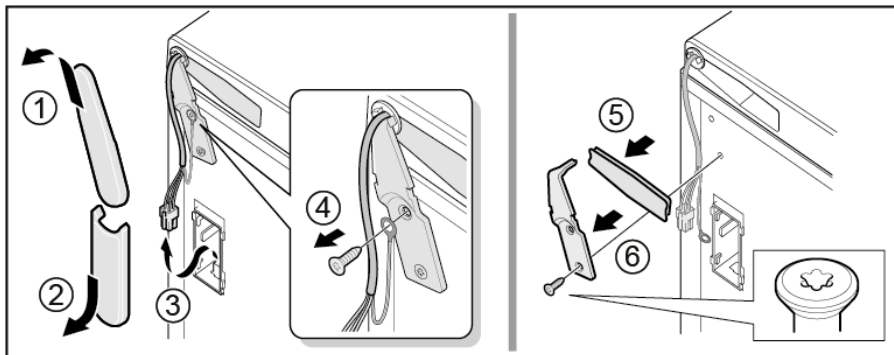

 Ο επάνω μεντεσές έχει αφαιρεθεί.

4.4.2 Τοποθέτηση επάνω μεντεσέ πόρτας

- ▶ Εγκαταστήστε με την αντίθετη σειρά.

4.5 Αντικατάσταση μεσαίου μεντεσέ πόρτας

Ειδικά βοηθητικά μέσα:

 Μύτη Torx TX20 6,3 mm (1/4") [00340865]

	<p style="text-align: center;">⚠ ΠΡΟΕΙΔΟΠΟΙΗΣΗ</p> <p>Βαριές, ογκώδεις συσκευές! Τραυματισμοί μέσης και μυών</p> <ul style="list-style-type: none"> ▶ Η διαδικασία αφαίρεσης της πόρτας της συσκευής πρέπει να εκτελείται μόνο από εκπαιδευμένους ειδικούς. ▶ Η μετακίνηση της συσκευής πρέπει να εκτελείται από δύο άτομα. ▶ Χρησιμοποιείτε μόνο κατάλληλα εργαλεία και εξοπλισμό.
--	--



	<p style="text-align: center;">⚠ ΠΡΟΣΟΧΗ</p> <p>Αιχμηρές ακμές! Τραυματισμοί από κοπή</p> <ul style="list-style-type: none"> ▶ Φοράτε προστατευτικά γάντια.
--	--

	<p style="text-align: center;">⚠ ΠΡΟΕΙΔΟΠΟΙΗΣΗ</p> <p>Ολίσθηση κεκλιμένων συσκευών! Κατάγματα οστών/τραυματισμοί σύνθλιψης</p> <ul style="list-style-type: none"> ▶ Ασφαλίστε τις συσκευές από ολίσθηση.
--	---

	<p style="text-align: center;">⚠ ΠΡΟΣΟΧΗ</p> <p>Κίνδυνοι από πτώση μερών εξαιτίας χαλαρών βιδών! Τραυματισμός εξαιτίας πτώσης τμημάτων.</p> <ul style="list-style-type: none"> ▶ Ασφαλίστε τα εξαρτήματα από πτώση.
---	--

	<p style="text-align: center;">ΠΡΟΣΟΧΗ!</p> <p>Κίνδυνων από πτώση εξαρτημάτων εξαιτίας χαλαρών βιδών! Ζημιά σε άλλα μέρη της συσκευής ή στην οικία του πελάτη, π.χ. δάπεδο.</p> <ul style="list-style-type: none"> ▶ Ασφαλίστε τα εξαρτήματα από πτώση.
--	--

Προϋπόθεση:

-  Η συσκευή είναι αποσυνδεδεμένη από την παροχή τροφοδοσίας.
-  Αφαιρούνται τα εσωτερικά εξαρτήματα συσκευής.
-  Ο επάνω μεντεσές έχει αφαιρεθεί.

4.5.1 Αφαίρεση μεσαίου μεντεσέ πόρτας

- ▶ 1. Αφαιρέστε την πόρτα χώρου ψυγείου (1).
- ▶ 2. Ξεβιδώστε δύο βίδες (2).
- ▶ 3. Αφαιρέστε τον μεσαίο μεντεσέ (3).

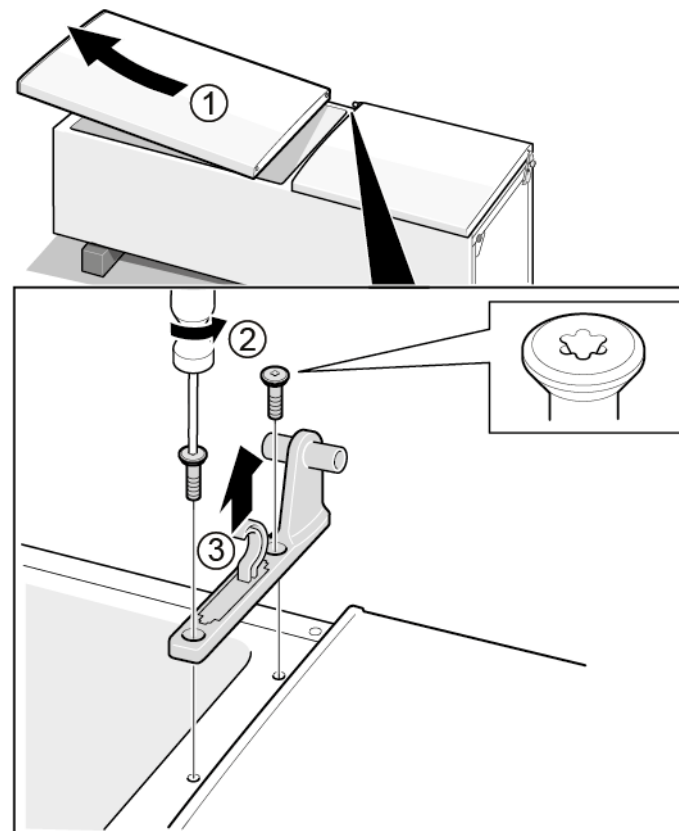

 Ο μεσαίος μεντεσές έχει αφαιρεθεί.

4.5.2 Τοποθέτηση μεσαίου μεντεσέ πόρτας

- ▶ Εγκαταστήστε με την αντίθετη σειρά.

4.6 Αντικατάσταση κάτω μεντεσέ πόρτας

Ειδικά βοηθητικά μέσα:

 Μύτη Torx TX20 6,3 mm (1/4") [00340865]

	⚠ ΠΡΟΕΙΔΟΠΟΙΗΣΗ
	<p>Βαριές, ογκώδεις συσκευές! Τραυματισμοί μέσης και μυών</p> <ul style="list-style-type: none"> ▶ Η διαδικασία αφαίρεσης της πόρτας της συσκευής πρέπει να εκτελείται μόνο από εκπαιδευμένους ειδικούς. ▶ Η μετακίνηση της συσκευής πρέπει να εκτελείται από δύο άτομα. ▶ Χρησιμοποιείτε μόνο κατάλληλα εργαλεία και εξοπλισμό.





	⚠ ΠΡΟΣΟΧΗ
	<p>Αιχμηρές ακμές! Τραυματισμοί από κοπή</p> <ul style="list-style-type: none"> ▶ Φοράτε προστατευτικά γάντια.

	⚠ ΠΡΟΕΙΔΟΠΟΙΗΣΗ
	<p>Ολίσθηση κεκλιμένων συσκευών! Κατάγματα οστών/τραυματισμοί σύνθλιψης</p> <ul style="list-style-type: none"> ▶ Ασφαλίστε τις συσκευές από ολίσθηση.

	⚠ ΠΡΟΣΟΧΗ
	<p>Κίνδυνοι από πτώση μερών εξαιτίας χαλαρών βιδών! Τραυματισμός εξαιτίας πτώσης τμημάτων.</p> <ul style="list-style-type: none"> ▶ Ασφαλίστε τα εξαρτήματα από πτώση.

	ΠΡΟΣΟΧΗ!
	<p>Κίνδυνων από πτώση εξαρτημάτων εξαιτίας χαλαρών βιδών! Ζημιά σε άλλα μέρη της συσκευής ή στην οικία του πελάτη, π.χ. δάπεδο.</p> <ul style="list-style-type: none"> ▶ Ασφαλίστε τα εξαρτήματα από πτώση.

Προϋπόθεση:

-  Η συσκευή είναι αποσυνδεδεμένη από την παροχή τροφοδοσίας.
-  Αφαιρούνται τα εσωτερικά εξαρτήματα συσκευής.
-  Ο επάνω μεντεσές έχει αφαιρεθεί.
-  Ο μεσαίος μεντεσές έχει αφαιρεθεί.

4.6.1 Αφαίρεση κάτω μεντεσέ πόρτας

- ▶ 1. Αφαιρέστε την πόρτα χώρου κατάψυξης (1).
- ▶ 2. Ξεβιδώστε τη βίδα (2).
- ▶ 3. Γυρίστε τον κάτω μεντεσέ προς τα έξω (3).
- ▶ 4. Αφαιρέστε τον κάτω μεντεσέ (4).

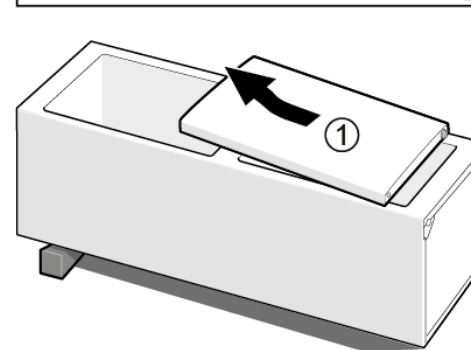
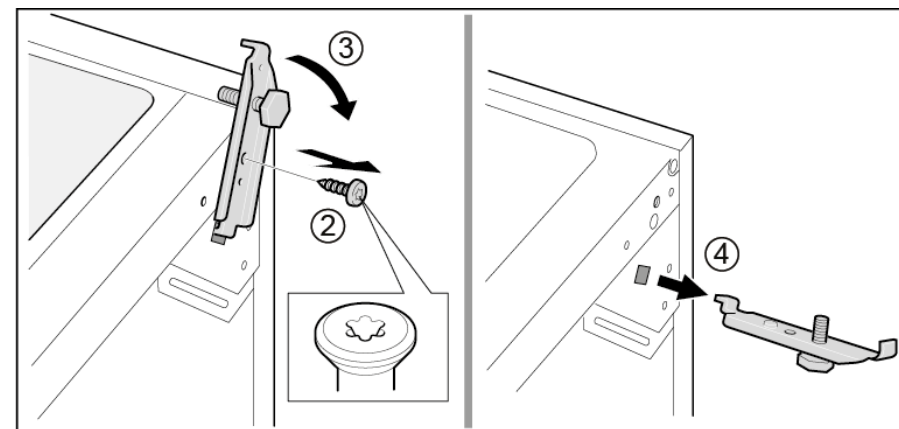

 Ο κάτω μεντεσές πόρτας έχει αφαιρεθεί.

4.6.2 Τοποθέτηση κάτω μεντεσέ πόρτας

- ▶ Εγκαταστήστε με την αντίθετη σειρά.

4.7 Αντικατάσταση ραφιού

Προϋπόθεση:

- ✔ Η πόρτα είναι ανοιχτή.

4.7.1 Αφαίρεση ραφιού

- ▶ Τραβήξτε το ράφι προς τα έξω.

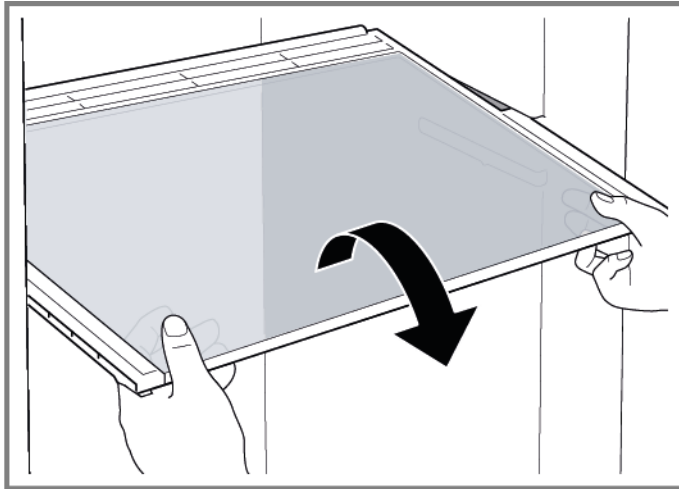

- ➡ Το ράφι αφαιρέθηκε.

4.7.2 Τοποθέτηση ραφιού

- ▶ Εγκαταστήστε με την αντίθετη σειρά.

4.8 Αντικατάσταση επιφάνειας εναπόθεσης φιαλών

Προϋπόθεση:

- ✔ Η πόρτα είναι ανοιχτή.

4.8.1 Αφαίρεση επιφάνειας εναπόθεσης φιαλών

- ▶ Τραβήξτε προς τα έξω την επιφάνεια εναπόθεσης φιαλών.

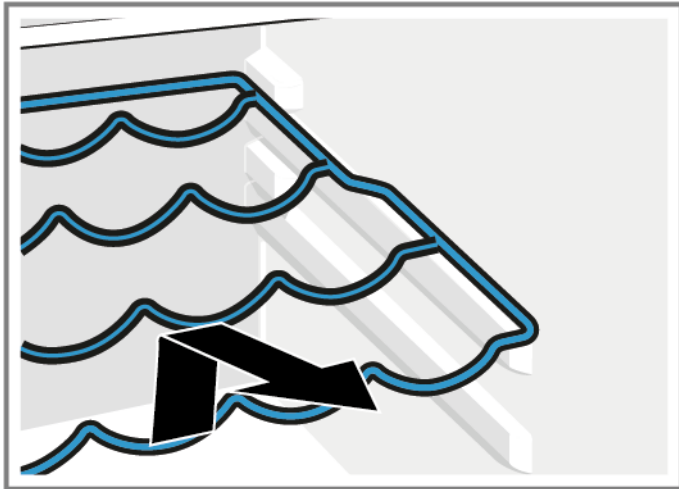

- ➡ Η επιφάνεια εναπόθεσης φιαλών έχει αφαιρεθεί.

4.8.2 Τοποθέτηση επιφάνειας εναπόθεσης φιαλών

- ▶ Εγκαταστήστε με την αντίθετη σειρά.

4.9 Αντικατάσταση ραφιού πόρτας

Προϋπόθεση:

- ✔ Η πόρτα είναι ανοιχτή.

4.9.1 Αφαίρεση ραφιού πόρτας

- ▶ Ανασηκώστε το ράφι πόρτας προς τα επάνω.

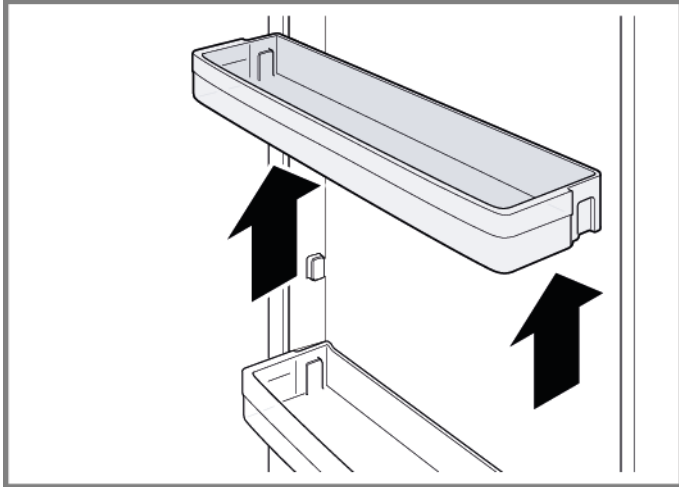

- ➡ Το ράφι πόρτας έχει αφαιρεθεί.

4.9.2 Τοποθέτηση ραφιού πόρτας

- ▶ Εγκαταστήστε με την αντίθετη σειρά.

4.10 Αντικατάσταση ραφιού πόρτας με δυνατότητα ρύθμισης

Προϋπόθεση:

- ✔ Η πόρτα είναι ανοιχτή.

4.10.1 Αφαίρεση ραφιού πόρτας με δυνατότητα ρύθμισης

- ▶ Μετακινήστε το ράφι πόρτας με δυνατότητα ρύθμισης ύψους, προς τα επάνω μέχρι το ράφι πόρτας να απελευθερωθεί από το στήριγμα.

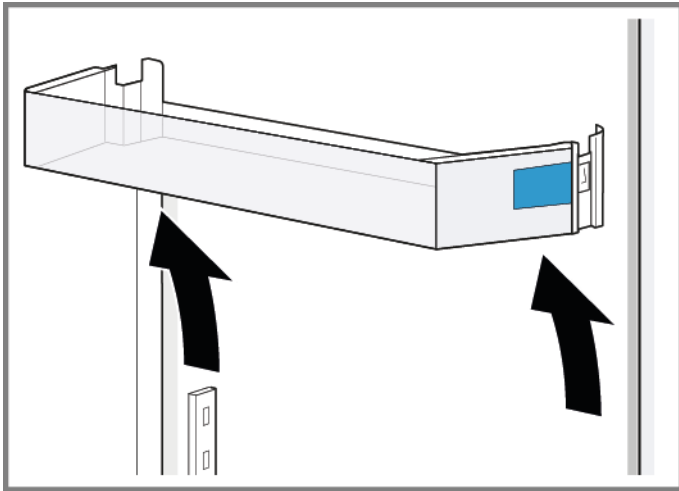

- ➡ Το ράφι πόρτας με δυνατότητα ρύθμισης έχει αφαιρεθεί.

4.10.2 Τοποθέτηση ραφιού πόρτας με δυνατότητα ρύθμισης

- ▶ Εγκαταστήστε με την αντίθετη σειρά.

4.11 Αντικατάσταση συρταριού κατεψυγμένων τροφίμων

Προϋπόθεση:

- ✔ Η πόρτα είναι ανοιχτή.

4.11.1 Αφαίρεση συρταριού κατεψυγμένων τροφίμων

- ▶ 1. Τραβήξτε προς τα έξω ολόκληρο το συρτάρι κατεψυγμένων τροφίμων (1).
- ▶ 2. Αφαιρέστε το συρτάρι τροφίμων (2).

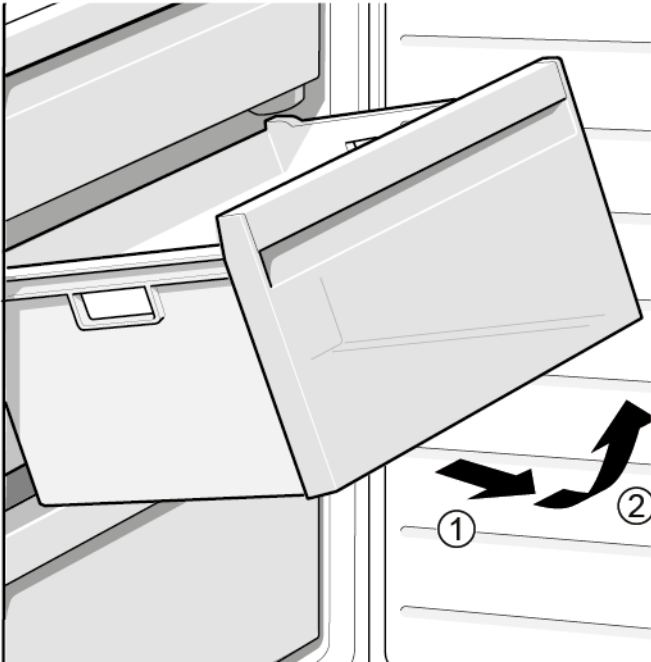

- ➡ Το συρτάρι κατεψυγμένων τροφίμων έχει αφαιρεθεί.

4.11.2 Τοποθέτηση συρταριού κατεψυγμένων τροφίμων

- ▶ Εγκαταστήστε με την αντίθετη σειρά.

4.12 Αντικατάσταση συρταριού

Προϋπόθεση:

- ✔ Η πόρτα είναι ανοιχτή.

4.12.1 Αφαίρεση συρταριού

- ▶ 1. Μετακινήστε προς τα έξω το κάτω συρτάρι ψυγείου (1).
- ▶ 2. Μετακινήστε προς τα έξω το επάνω συρτάρι ψυγείου (2).

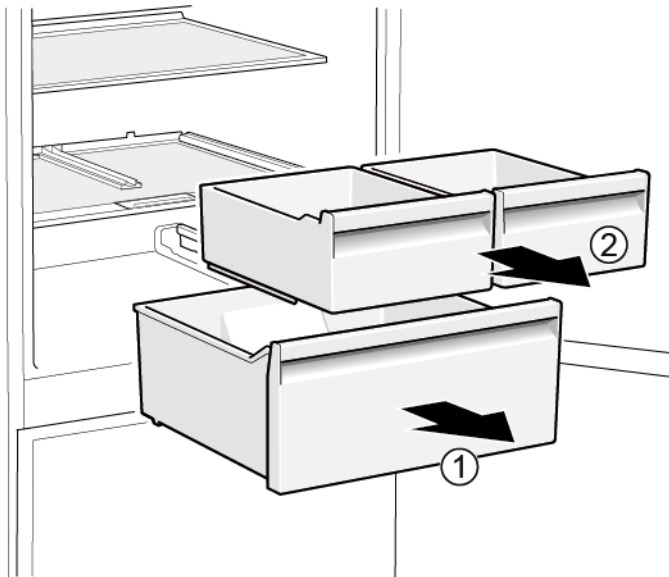

- ➡ Τα συρτάρια έχουν αφαιρεθεί.

4.12.2 Τοποθέτηση συρταριού

- ▶ Εγκαταστήστε με την αντίθετη σειρά.

4.13 Αντικατάσταση τηλεσκοπικού συρταριού

Προϋπόθεση:

- ✔ Η πόρτα είναι ανοιχτή.

4.13.1 Αφαίρεση τηλεσκοπικού συρταριού

- ▶ 1. Τραβήξτε προς τα έξω ολόκληρο το τηλεσκοπικό συρτάρι (1).
- ▶ 2. Αφαιρέστε το τηλεσκοπικό συρτάρι (2).

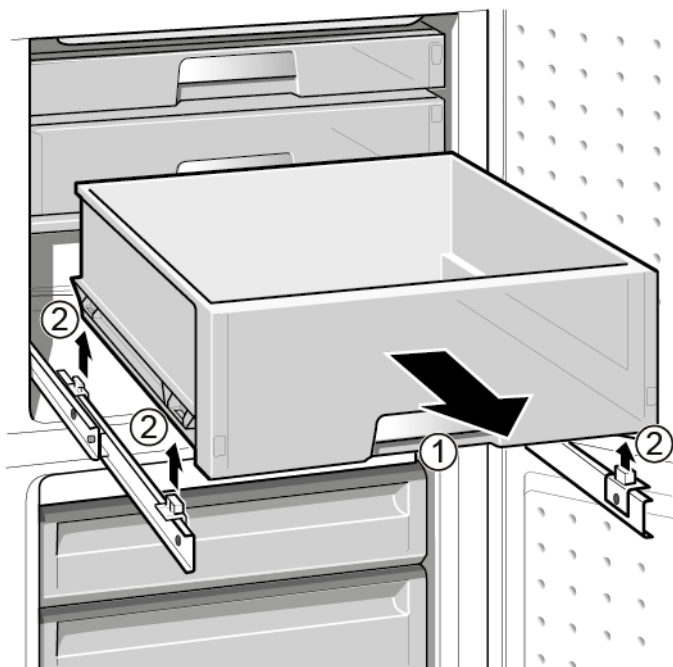

- ➡ Το τηλεσκοπικό συρτάρι αφαιρέθηκε.

4.13.2 Τοποθέτηση τηλεσκοπικού συρταριού

- ▶ Εγκαταστήστε με την αντίθετη σειρά.

4.14 Αντικατάσταση spot φωτισμού LED

Ειδικά βοηθητικά μέσα:

Ειδικό εργαλείο [00342180]



Η συσκευή διαθέτει ένα φως LED που δεν χρειάζεται συντήρηση. Αυτά τα φώτα μπορούν να επισκευαστούν μόνο από την εξυπηρέτηση πελατών ή από εξουσιοδοτημένους τεχνικούς!



ΚΙΝΔΥΝΟΣ

Κίνδυνος ηλεκτροπληξίας λόγω ηλεκτροφόρων μερών!

Κίνδυνος για τη ζωή από ηλεκτροπληξία σε περίπτωση ακατάλληλης επισκευής

- ▶ Τα ηλεκτρικά μέρη πρέπει να επισκευάζονται από εκπαιδευμένους ηλεκτρολόγους.
- ▶ Μετά την επισκευή πραγματοποιήστε έλεγχο ασφάλειας σύμφωνα με το VDE 0701 ή κανονισμούς της συγκεκριμένης χώρας.



ΚΙΝΔΥΝΟΣ

Κίνδυνος ηλεκτροπληξίας λόγω ηλεκτροφόρων μερών!

Θάνατος από ηλεκτροπληξία

- ▶ Αποσυνδέετε τις συσκευές από την παροχή ηλεκτρικού ρεύματος τουλάχιστον 60 δευτερόλεπτα πριν ξεκινήσετε τις επισκευές.



ΠΡΟΣΟΧΗ

Αιχμηρές ακμές!

Τραυματισμοί από κοπή

- ▶ Φοράτε προστατευτικά γάντια.

Προϋπόθεση:

- ✔ Η συσκευή είναι αποσυνδεδεμένη από την παροχή τροφοδοσίας.
- ✔ Η πόρτα είναι ανοιχτή.

4.14.1 Αφαίρεση spot φωτισμού LED

1. Χρησιμοποιήστε ειδικό εργαλείο για να τραβήξετε προς τα έξω το spot φωτισμού LED (1).

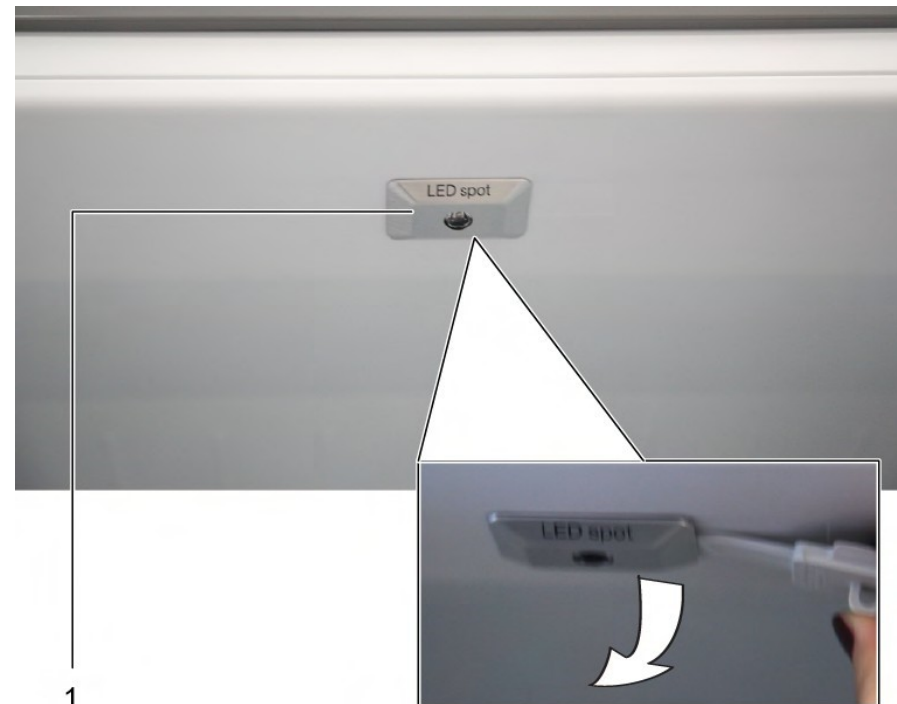

2. Αποσυνδέστε τις ηλεκτρικές συνδέσεις του spot φωτισμού LED.
➡ Το spot φωτισμού LED αφαιρέθηκε.

4.14.2 Τοποθέτηση spot φωτισμού LED

- ▶ Εγκαταστήστε με την αντίθετη σειρά.

4.15 Αντικατάσταση επάνω φωτός LED

Ειδικά βοηθητικά μέσα:

Πλακέ κατσαβίδι
Λεπίδα 2,4 mm x 0,4 mm x 60 mm,
στο κιτ [00341820]



Η συσκευή διαθέτει ένα φως LED που δεν χρειάζεται συντήρηση. Αυτά τα φώτα μπορούν να επισκευαστούν μόνο από την εξυπηρέτηση πελατών ή από εξουσιοδοτημένους τεχνικούς!



ΚΙΝΔΥΝΟΣ

Κίνδυνος ηλεκτροπληξίας λόγω ηλεκτροφόρων μερών!

Κίνδυνος για τη ζωή από ηλεκτροπληξία σε περίπτωση ακατάλληλης επισκευής

- ▶ Τα ηλεκτρικά μέρη πρέπει να επισκευάζονται από εκπαιδευμένους ηλεκτρολόγους.
- ▶ Μετά την επισκευή πραγματοποιήστε έλεγχο ασφάλειας σύμφωνα με το VDE 0701 ή κανονισμούς της συγκεκριμένης χώρας.



ΚΙΝΔΥΝΟΣ

Κίνδυνος ηλεκτροπληξίας λόγω ηλεκτροφόρων μερών!

Θάνατος από ηλεκτροπληξία

- ▶ Αποσυνδέετε τις συσκευές από την παροχή ηλεκτρικού ρεύματος τουλάχιστον 60 δευτερόλεπτα πριν ξεκινήσετε τις επισκευές.



ΠΡΟΣΟΧΗ

Αιχμηρές ακμές!

Τραυματισμοί από κοπή

- ▶ Φοράτε προστατευτικά γάντια.

Προϋπόθεση:

- ✔ Η συσκευή είναι αποσυνδεδεμένη από την παροχή τροφοδοσίας.
- ✔ Η πόρτα είναι ανοιχτή.
- ✔ Αφαιρούνται τα επάνω εσωτερικά εξαρτήματα.

4.15.1 Αφαίρεση φωτός LED

1. Μετακινήστε το φως LED στην αριστερή πλευρά.

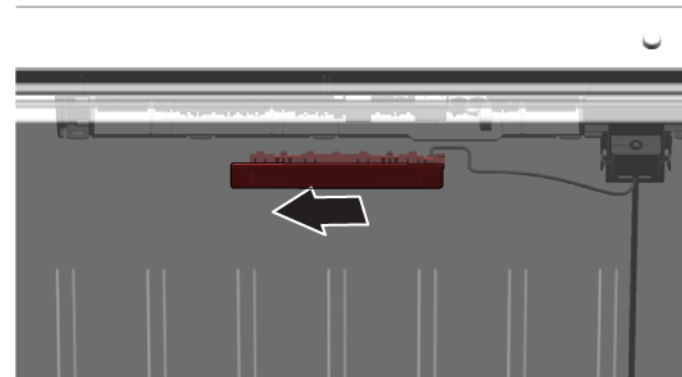

➡ Η ηλεκτρική σύνδεση φωτισμού LED είναι αποσυνδεδεμένη.

2. Απελευθερώστε τα άγκιστρα φωτισμού LED.

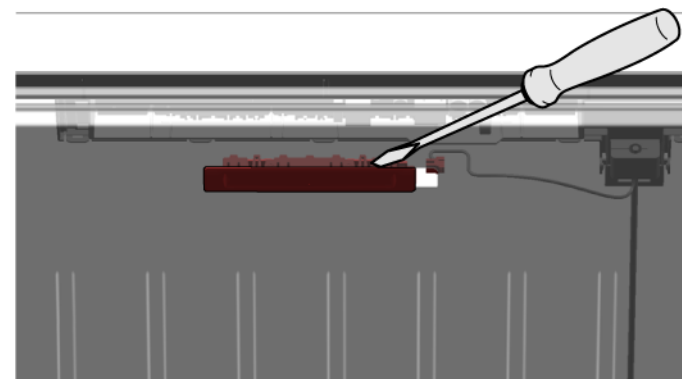

3. Αφαιρέστε το φως LED, μετακινώντας το προς τα εμπρός.

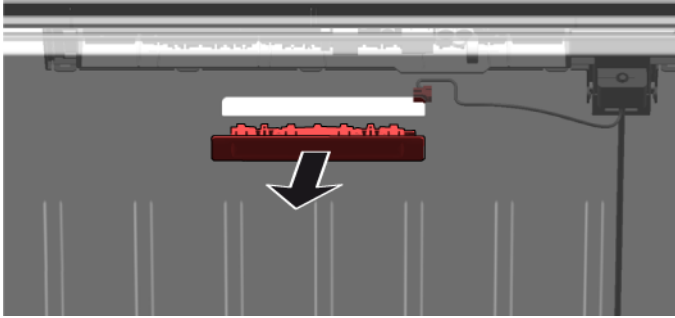

- ➔ Το φως LED αφαιρέθηκε.

4.15.2 Τοποθέτηση επάνω φωτισμού LED

- ▶ Εγκαταστήστε με την αντίθετη σειρά.

4.16 Αντικατάσταση πλευρικής ράβδου φωτισμού LED

Ειδικά βοηθητικά μέσα:

Βεντούζα Ø50 mm [00342224]



Η συσκευή διαθέτει ένα φως LED που δεν χρειάζεται συντήρηση. Αυτά τα φώτα μπορούν να επισκευαστούν μόνο από την εξυπηρέτηση πελατών ή από εξουσιοδοτημένους τεχνικούς!



ΚΙΝΔΥΝΟΣ

Κίνδυνος ηλεκτροπληξίας λόγω ηλεκτροφόρων μερών!

Κίνδυνος για τη ζωή από ηλεκτροπληξία σε περίπτωση ακατάλληλης επισκευής

- ▶ Τα ηλεκτρικά μέρη πρέπει να επισκευάζονται από εκπαιδευμένους ηλεκτρολόγους.
- ▶ Μετά την επισκευή πραγματοποιήστε έλεγχο ασφάλειας σύμφωνα με το VDE 0701 ή κανονισμούς της συγκεκριμένης χώρας.



ΚΙΝΔΥΝΟΣ

Κίνδυνος ηλεκτροπληξίας λόγω ηλεκτροφόρων μερών!

Θάνατος από ηλεκτροπληξία

- ▶ Αποσυνδέετε τις συσκευές από την παροχή ηλεκτρικού ρεύματος τουλάχιστον 60 δευτερόλεπτα πριν ξεκινήσετε τις επισκευές.



ΠΡΟΣΟΧΗ

Αιχμηρές ακμές!

Τραυματισμοί από κοπή

- ▶ Φοράτε προστατευτικά γάντια.

Προϋπόθεση:

- ✔ Η συσκευή είναι αποσυνδεδεμένη από την παροχή τροφοδοσίας.
- ✔ Η πόρτα είναι ανοιχτή.
- ✔ Τα ράφια χώρου ψυγείου έχουν αφαιρεθεί.

4.16.1 Αφαίρεση πλευρικής ράβδου φωτισμού LED

1. Κολλήστε τη βεντούζα στο επάνω ένα τρίτο της πλευρικής ράβδου φωτισμού LED.



2. Τραβήξτε τη βεντούζα προς το μέρος σας με την πλευρική ράβδο φωτισμού LED με μια περιστροφική κίνηση.

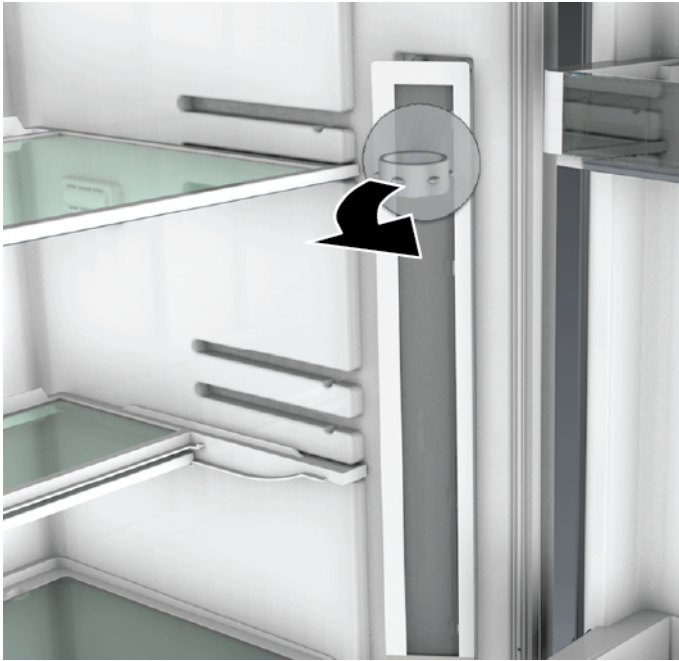



3. Αποσυνδέστε την ηλεκτρική σύνδεση της πλευρικής ράβδου φωτισμού LED.
➡ Η πλευρική ράβδος φωτισμού LED αφαιρέθηκε.

4.16.2 Τοποθέτηση πλευρικής ράβδου φωτισμού LED

1. Συνδέστε την ηλεκτρική σύνδεση της πλευρικής ράβδου φωτισμού LED.
 2. Στερεώστε την πλευρική ράβδο φωτισμού LED στη θέση της στο τοίχωμα του χώρου (τα άγκιστρα κουμπώνουν με χαρακτηριστικό ήχο).
- ➡ Η πλευρική ράβδος φωτισμού LED τοποθετήθηκε.

4.17 Αντικατάσταση προβολέα LED

Ειδικά βοηθητικά μέσα:

-  Ειδικό εργαλείο [00342180]
-  Πλακέ κατσαβίδι Λεπίδα 2,4 mm x 0,4 mm x 60 mm, στο κιτ [00341820]

 Η συσκευή διαθέτει ένα φως LED που δεν χρειάζεται συντήρηση. Αυτά τα φώτα μπορούν να επισκευαστούν μόνο από την εξυπηρέτηση πελατών ή από εξουσιοδοτημένους τεχνικούς!

 **⚠ ΚΙΝΔΥΝΟΣ**
Κίνδυνος ηλεκτροπληξίας λόγω ηλεκτροφόρων μερών!
 Κίνδυνος για τη ζωή από ηλεκτροπληξία σε περίπτωση ακατάλληλης επισκευής

- ▶ Τα ηλεκτρικά μέρη πρέπει να επισκευάζονται από εκπαιδευμένους ηλεκτρολόγους.
- ▶ Μετά την επισκευή πραγματοποιήστε έλεγχο ασφάλειας σύμφωνα με το VDE 0701 ή κανονισμούς της συγκεκριμένης χώρας.



 **⚠ ΚΙΝΔΥΝΟΣ**
Κίνδυνος ηλεκτροπληξίας λόγω ηλεκτροφόρων μερών!
 Θάνατος από ηλεκτροπληξία

- ▶ Αποσυνδέετε τις συσκευές από την παροχή ηλεκτρικού ρεύματος τουλάχιστον 60 δευτερόλεπτα πριν ξεκινήσετε τις επισκευές.

 **⚠ ΠΡΟΣΟΧΗ**
Αιχμηρές ακμές!
 Τραυματισμοί από κοπή

- ▶ Φοράτε προστατευτικά γάντια.

Προϋπόθεση:

-  Η συσκευή είναι αποσυνδεδεμένη από την παροχή τροφοδοσίας.
-  Η πόρτα είναι ανοιχτή.
-  Τα ράφια χώρου συντήρησης έχουν αφαιρεθεί.

4.17.1 Αφαίρεση spot φωτισμού LED

1. Απελευθερώστε το κάλυμμα spot φωτισμού LED.

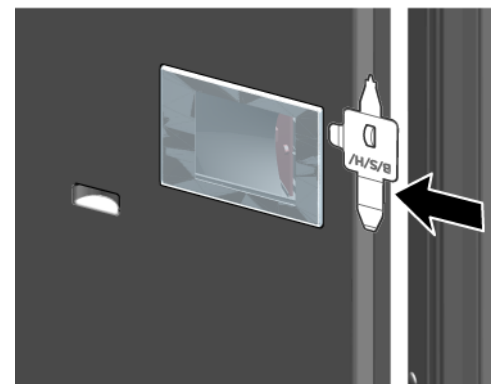

2. Τραβήξτε το κάλυμμα spot φωτισμού LED προς τα μέσα και ταυτόχρονα σπρώξτε προς τα εμπρός.

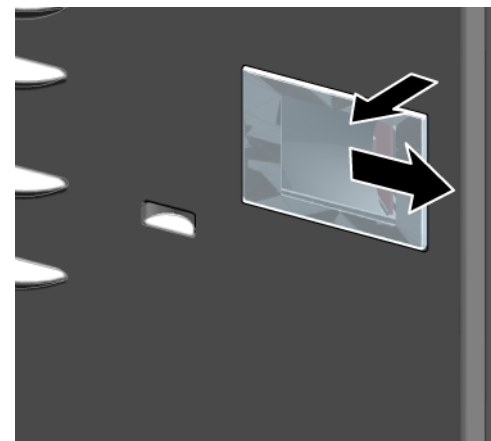

3. Απασφαλίστε τη μονάδα spot φωτισμού LED.

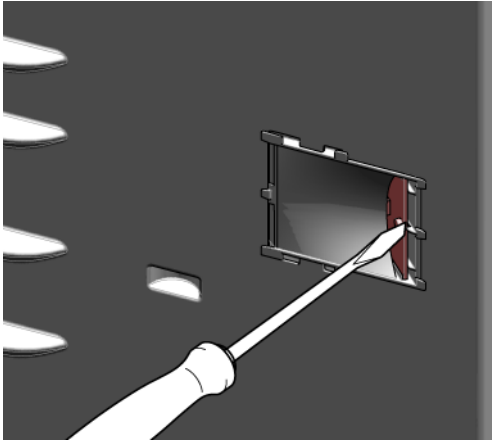

4. Αποσυνδέστε την ηλεκτρική σύνδεση spot φωτισμού LED.

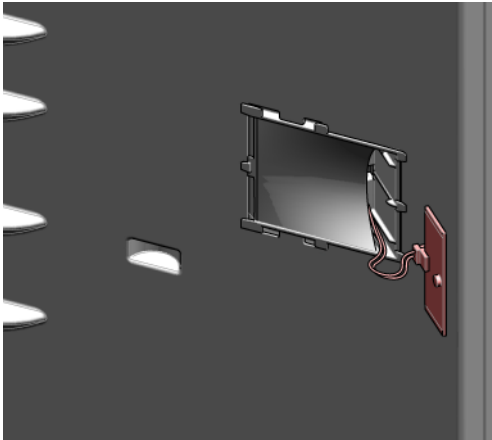





-  Το spot φωτισμού LED αφαιρέθηκε.

4.17.2 Τοποθέτηση spot φωτισμού LED

- ▶ Εγκαταστήστε με την αντίθετη σειρά.

Javítási útmutató - Hűtő-/fagyasztó-kombináció

 A dokumentummal kapcsolatos információk.....	322
1.1 Fontos tudnivalók	322
1.1.1 Cél	322
1.2 Szimbólummagyarázat	322
1.2.1 Veszélyességi szintek	322
1.2.2 Veszélyt jelző szimbólumok	322
1.2.3 A figyelmeztetések felépítése	323
1.2.4 Általános szimbólumok.....	323
 Biztonság	324
2.1 Általános biztonsági utasítások.....	324
2.1.1 Összes háztartási készülék	324
 Szerszámok és segédanyagok.....	325
 Javítás	326
4.1 A gumitömítés cseréje	326
4.1.1 A gumitömítés eltávolítása.....	326
4.1.2 A gumitömítés beszerelése.....	326
4.2 A fogantyú cseréje.....	329
4.2.1 A fogantyú eltávolítása	329
4.2.2 A fogantyú felszerelése	329
4.3 A felső ajtózsanér cseréje	330
4.3.1 A felső ajtózsanér eltávolítása.....	330
4.3.2 A felső ajtózsanér felhelyezése	331
4.4 A felső ajtózsanér cseréje (kijelzős ajtó).....	332
4.4.1 A felső ajtózsanér eltávolítása.....	332
4.4.2 A felső ajtózsanér felhelyezése	333
4.5 A középső ajtózsanér cseréje.....	334
4.5.1 A középső ajtózsanér eltávolítása	334
4.5.2 A középső ajtózsanér felhelyezése	334
4.6 Az alsó ajtózsanér cseréje	335
4.6.1 Az alsó ajtózsanér eltávolítása	335
4.6.2 Az alsó ajtózsanér felhelyezése	335
4.7 A polc cseréje	336
4.7.1 A polc eltávolítása	336
4.7.2 A polc beszerelése.....	336

4.8 A palacktartó cseréje.....	337
4.8.1 A palacktartó eltávolítása	337
4.8.2 A palacktartó telepítése	337
4.9 Az ajtópolc cseréje	338
4.9.1 Az ajtópolc eltávolítása	338
4.9.2 Az ajtópolc felhelyezése.....	338
4.10 Az állítható ajtópolc cseréje	339
4.10.1 Az állítható ajtópolc eltávolítása.....	339
4.10.2 Az állítható ajtópolc behelyezése.....	339
4.11 Fagyasztódoboz cseréje.....	340
4.11.1 Fagyasztódoboz eltávolítása	340
4.11.2 A fagyasztódoboz behelyezése	340
4.12 Tároló cseréje.....	341
4.12.1 Tároló eltávolítása	341
4.12.2 A tároló behelyezése	341
4.13 A kihúzható tároló cseréje	342
4.13.1 A kihúzható tároló eltávolítása.....	342
4.13.2 A kihúzható tároló behelyezése	342
4.14 LED-es oldalsó spotvilágítás cseréje	343
4.14.1 LED-es spotvilágítás eltávolítása	343
4.14.2 A LED-es spotvilágítás beszerelése.....	343
4.15 Felső LED-világítás cseréje	344
4.15.1 LED-világítás eltávolítása.....	344
4.15.2 A felső LED-világítás beszerelése	345
4.16 A LED-es oldalvilágítás cseréje.....	346
4.16.1 LED-es oldalvilágítás eltávolítása	346
4.16.2 A LED-es oldalvilágítás beszerelése.....	347
4.17 LED-es oldalsó spotvilágítás cseréje	348
4.17.1 LED-es spotvilágítás eltávolítása	348
4.17.2 A LED-es spotvilágítás beszerelése.....	349

i A dokumentummal kapcsolatos információk

1.1 Fontos tudnivalók

1.1.1 Cél

Ezek a javítási tanácsok támogatják a fogyasztót a készülékek otthoni megjavításában a környezettudatos tervezésről szóló rendeletnek (2021 márciusától alkalmazandó) megfelelően.



Információkat tartalmaznak bizonyos pótalkatrészek cseréjével kapcsolatban, ideértve a figyelmeztetéseket és a kockázatokat is.

Ha kérdése van, vegye fel a kapcsolatot a vevőszolgálattal. A károkért kizárólag akkor vállalunk felelősséget, ha a javítási tanácsokat pontosan betartották.

1.2 Szimbólummagyarázat

1.2.1 Veszélyességi szintek

A veszélyességi szintek egy szimbólumból és egy figyelmeztető mondatból állnak. A figyelmeztető mondat utal a veszély súlyosságára.





Veszélyességi szint	Jelentés
 VESZÉLY	A figyelmeztető üzenet figyelmen kívül hagyása halált vagy súlyos sérüléseket okoz.
 FIGYELMEZTETÉS	A figyelmeztető üzenet figyelmen kívül hagyása halált vagy súlyos sérüléseket okozhat.
 VIGYÁZAT	A figyelmeztető üzenet figyelmen kívül hagyása kisebb sérüléseket okozhat.
 FIGYELEM!	A figyelmeztető üzenet figyelmen kívül hagyása anyagi károkat okozhat.

Táblázat 1: Veszélyességi szintek

1.2.2 Veszélyt jelző szimbólumok

A veszélyt jelző szimbólumok a veszélyt ábrázoló szimbolikus ábrázolások.

A jelen dokumentumban az alábbi veszélyt jelző szimbólumok használatosak:

Veszélyt jelző szimbólum	Jelentés
	Általános figyelmeztető üzenet
	Elektromos feszültség veszélye
	Robbanásveszély
	Vágásveszély
	Zúzódásveszély

i A dokumentummal kapcsolatos információk

Veszélyt jelző szimbólum	Jelentés
	Forró felületek miatt fennálló veszély
	Erős mágneses mező miatt fennálló veszély
	Nem ionizáló sugárzás veszélye

Táblázat 2: Veszélyt jelző szimbólumok

1.2.3 A figyelmeztetések felépítése

A jelen dokumentumban lévő figyelmeztetések szabványosított megjelenésűek és felépítésűek.

	⚠ VESZÉLY
A veszély típusa és forrása!	
A veszély / figyelmeztetés figyelmen kívül hagyásának lehetséges következményei.	
▶ A veszély megelőzésére szolgáló intézkedések és tiltások.	

Az alábbi példa egy olyan figyelmeztetést mutat be, amely az áram alatt lévő alkatrészek okozta áramütésre figyelmeztet. Megemlíti a veszély elkerülésére szolgáló intézkedést.

	⚠ VESZÉLY
Áramütés veszélye áram alatt lévő alkatrészek miatt!	
Halálos áramütés	
▶ A javítás megkezdése előtt legalább 60 másodperccel válassza le a készülékeket az elektromos hálózatról.	

1.2.4 Általános szimbólumok

A jelen dokumentumban az alábbi általános szimbólumok használatosak:

Ált. szimbólum	Jelentés
	Különleges tanács (szöveg és/vagy grafika)

Ált. szimbólum	Jelentés
	Egyszerű tanács (csak szöveg)
	Videós oktatóanyagra mutató hivatkozás
	A szükséges eszközök
	A szükséges feltételek
	Feltétel (ha..., akkor...)
	Eredmény
[Indítás]	Billentyű vagy gomb
[00123456]	Anyagszám azonosítója
Állapot	Megjelenített szöveg / ablak (a készülék kijelzőjén)

Táblázat 3: Általános szimbólumok

2.1 Általános biztonsági utasítások

2.1.1 Összes háztartási készülék

Áramütés veszélye áram alatt lévő alkatrészek miatt!

- Az elektromos alkatrészek hibás javítása áramütéshez vezethet!
- A javítás megkezdése előtt legalább 60 másodperccel válassza le a készüléket az elektromos hálózatról.
- A javítás után végeztesse a VDE 0701-nek vagy az országspecifikus szabályozásoknak megfelelő vizsgálatot.

Éles peremek miatt fennálló sérülésveszély!

- Viseljen védőkesztyűt.

Zúzódásveszély a javítás, karbantartás, hibaelhárítás és szervizelés során a nehéz és mozgó alkatrészek miatt

- Viseljen védőcipőt.
- Biztosítsa leesés ellen a nehéz alkatrészeket.
- Ne dugja be a testrészeit a mozgó alkatrészek közé.





Sérülhet a készülék biztonsága / működése!

- Kizárólag eredeti pótalkatrészeket használjon.

Elektrosztatikailag érzékeny alkatrészek (ESD-k) károsodásának veszélye!

- Ne érintse meg a modulokat, ideértve a csatlakozásokat és a vezetőket.

Szerszámok és segédanyagok

Kijelölés	Részletek	Képek
Védőrongy [00342013]	60 cm x 50 cm	
Laposfejű csavarhúzó	Hegy 2,4 mm x 0,4 mm x 60 mm, a készletben [00341820]	
Különleges szer- szám [00342180]		
Tapadókorong [00342224]	Ø50 mm	
TX20 Torx bithegy [00340865]	6,3 mm (1/4")	
Laposfejű csavarhúzó	Hegy 10 mm x 1,6 mm x 200 mm	

4.1 A gumitömítés cseréje

Követelmény:

- ✓ Az ajtó nyitva van

4.1.1 A gumitömítés eltávolítása

1. Vegye ki a gumitömítést a barázdából a jobb és a bal sarokban.



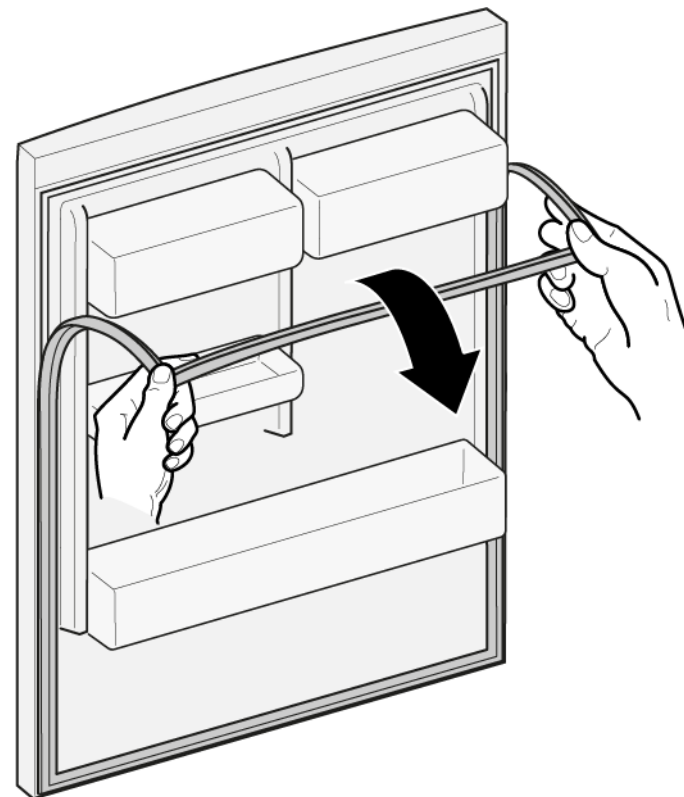

2. Húzza ki a gumitömítést a barázdából.



- ➡ Eltávolította a gumitömítést.

4.1.2 A gumitömítés beszerelése

	Az új gumitömítés vastagsága enyhén eltérhet a régi gumitömítés vastagságától. Ez nem befolyásolja az ajtócsukás módját és hosszú távú működését.
	Ha a készülékében beállítható zsanérok vagy zsanérrögzítések vannak, utólag optimalizálhatja a becsukás módját.
	A gumitömítésben lévő apró, oldalsó lyukak funkcionálisak (a szellőzéshez szükségesek). Ezek nem gyártási hibák.

1. Ellenőrizze a barázdát sérülések szempontjából.

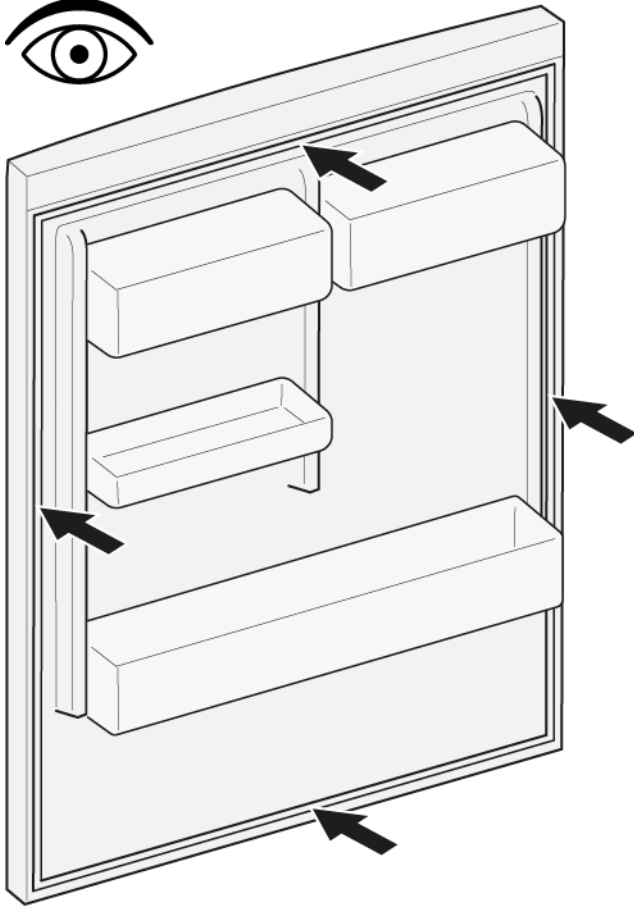

4. Nyomja a gumitömítés fenti és lenti sarkait a barázdába.

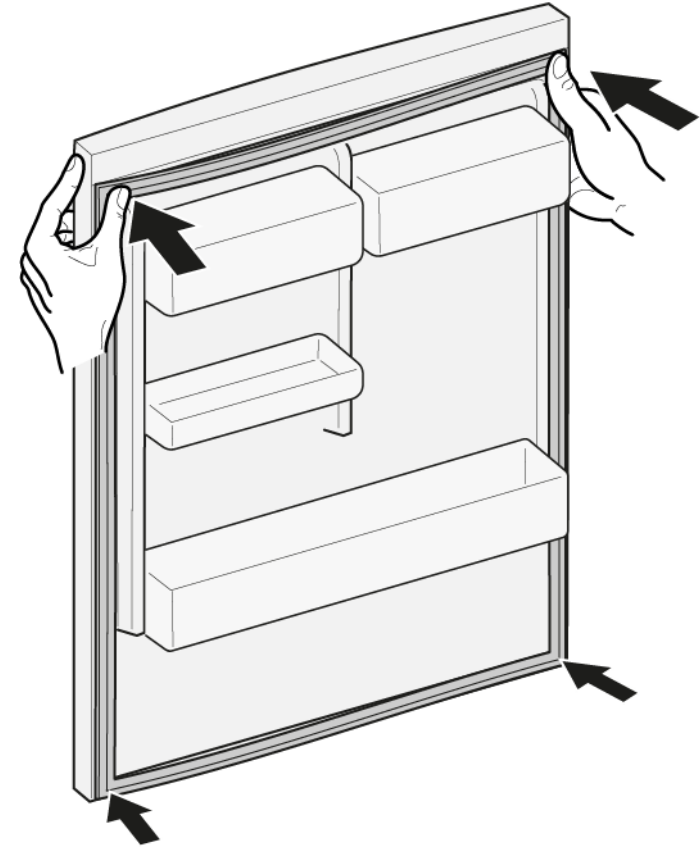



2.  Ha a gumitömítés barázdája sérült:
- Vegye fel a kapcsolatot az ügyfélszolgálattal.

3.  A gumitömítés enyhe deformálódása normális, és nem befolyásolja a működését. Javasolt a gumitömítés kiegyenesítése a készülékbe történő behelyezés előtt.

Hajszárítóval vagy forró vízzel melegítse fel a gumitömítést, és kézzel formázza újra.

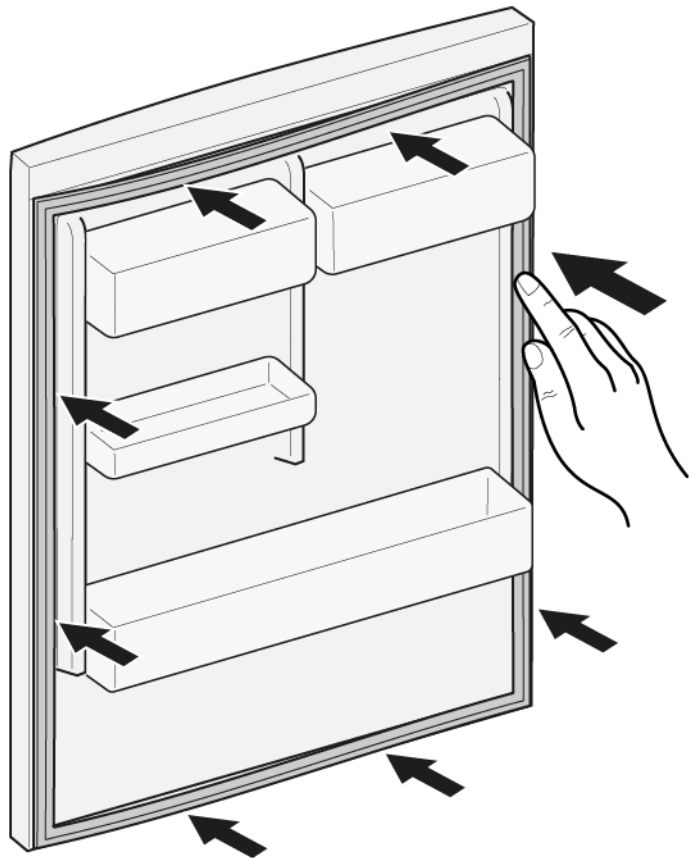
5. Nyomja a teljes gumitömítést apránként a barázdába.



-  Beszerelte a gumitömítést.

4.2 A fogantyú cseréje

Különleges eszközök

- TX20 Torx bithegy 6,3 mm (1/4") [00340865]
- Laposfejű csavarhúzó Hegy 10 mm x 1,6 mm x 200 mm

Követelmény:

- ✓ A készüléket leválasztotta az áramellátásról.
- ✓ Az ajtó nyitva van

4.2.1 A fogantyú eltávolítása

- ▶ 1. Távolítsa el a két csavarfedelelet (1).
- ▶ 2. Csavarja ki a két csavart (2).
- ▶ 3. Távolítsa el a fogantyút (3).

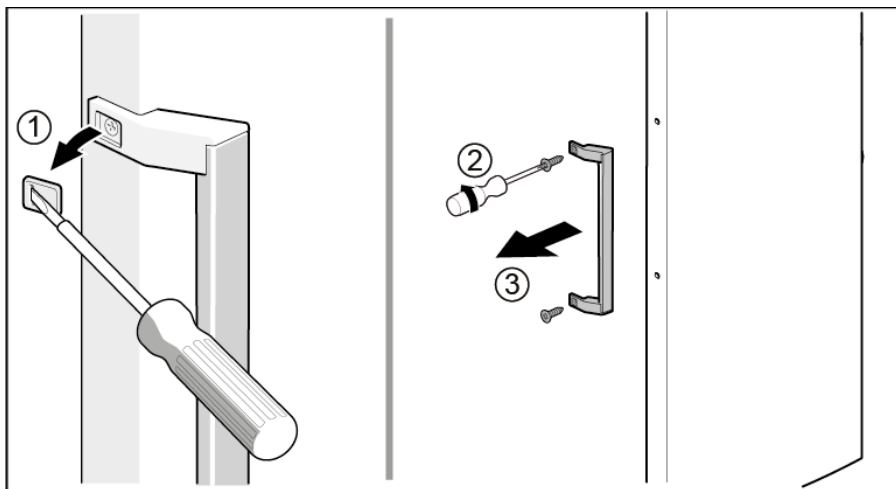

➡ Eltávolította a fogantyút.



A második ajtó fogantyújának eltávolítása ugyanígy történik.

4.2.2 A fogantyú felszerelése

- ▶ Az elhelyezést fordított sorrendben végezze.

4.3 A felső ajtózsanér cseréje

Különleges eszközök

 TX20 Torx bithegy

6,3 mm (1/4")

[00340865]

	⚠ FIGYELMEZTETÉS
	<p>Nehéz, nagy készülékek! Hát- és izomsérülések</p> <ul style="list-style-type: none"> ▶ A készülék ajtajának eltávolítását kizárólag szakemberrel végeztesse. ▶ A készülék elmozdításához két emberre van szükség. ▶ Kizárólag megfelelő eszközöket és berendezéseket használjon.



	⚠ VIGYÁZAT
	<p>Éles szélek! Vágási sérülések</p> <ul style="list-style-type: none"> ▶ Viseljen védőkesztyűt.

	⚠ FIGYELMEZTETÉS
	<p>Megdöntött készülékek elcsúszása! Csonttörés / zúzódási sérülések</p> <ul style="list-style-type: none"> ▶ Biztosítsa a készülékeket elcsúszás ellen.

	⚠ VIGYÁZAT
	<p>Leeső alkatrészek veszélye a kioldott csavarok miatt! Leeső alkatrészek miatti sérülés.</p> <ul style="list-style-type: none"> ▶ Biztosítsa az alkatrészt leesés ellen.

	FIGYELEM!
	<p>Leeső alkatrészek veszélye a kioldott csavarok miatt! A készülék többi részeinek vagy az ügyfél lakásának (pl. padló) károsodása.</p> <ul style="list-style-type: none"> ▶ Biztosítsa az alkatrészt leesés ellen.

Követelmény:

-  A készüléket leválasztotta az áramellátásról.
-  Eltávolította a készülék belső szerelvényeit.

4.3.1 A felső ajtózsanér eltávolítása

1. Fordítsa a készüléket a hátára.

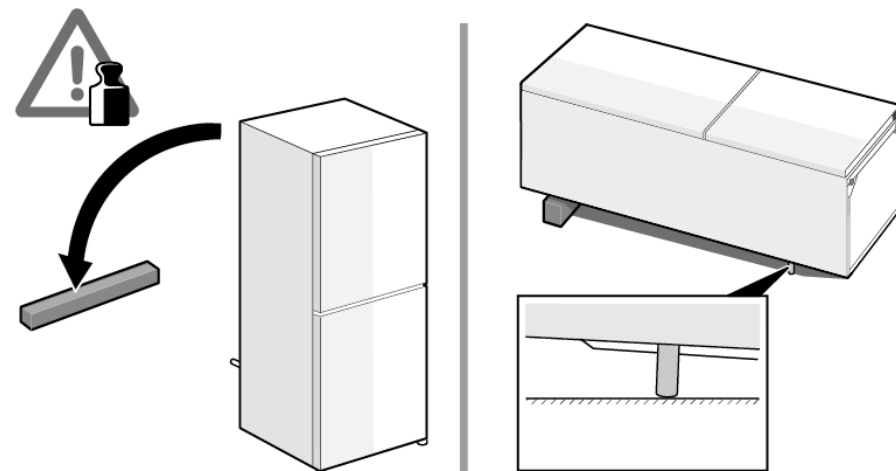

2. 1. Nyomja meg mindkét oldalon a felső zsanér burkolatát (1).
2. Húzza el a felső zsanér burkolatát (2).
3. Fordítsa el a zsanérburkolatot (3).
4. Távolítsa el a felső zsanér burkolatát (4).
5. Csavarja ki a két csavart (5).
6. Távolítsa el a felső zsanért (6)/.

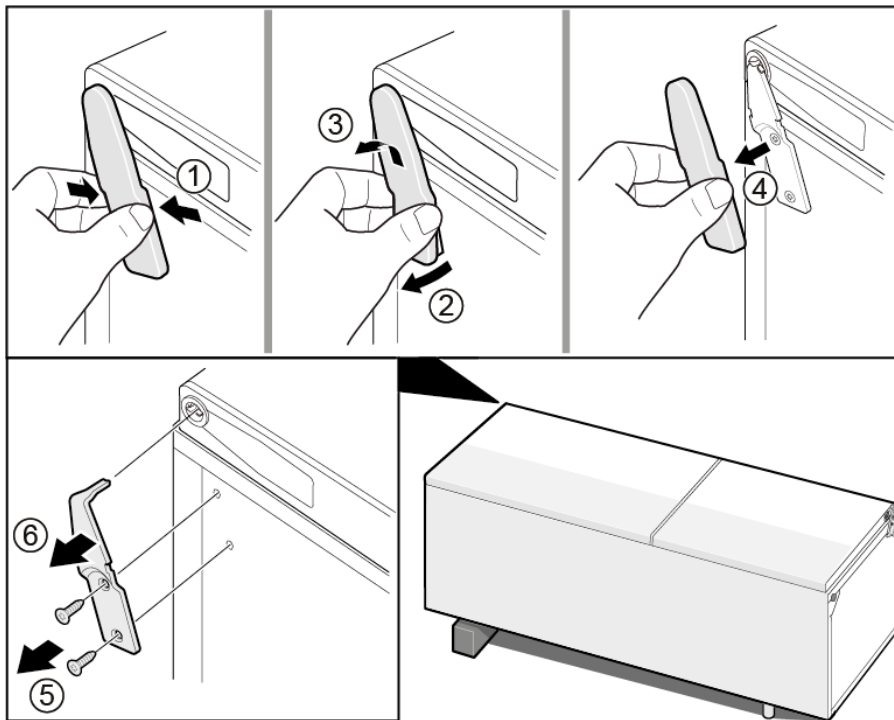

 Eltávolította a felső zsanért.

4.3.2 A felső ajtózsánér felhelyezése

- ▶ Az elhelyezést fordított sorrendben végezze.

4.4 A felső ajtózsanér cseréje (kijelzős ajtó)

Különleges eszközök

 TX20 Torx bithegy 6,3 mm (1/4") [00340865]

	⚠ FIGYELMEZTETÉS
	<p>Nehéz, nagy készülékek! Hát- és izomsérülések</p> <ul style="list-style-type: none"> ▶ A készülék ajtajának eltávolítását kizárólag szakemberrel végeztesse. ▶ A készülék elmozdításához két emberre van szükség. ▶ Kizárólag megfelelő eszközöket és berendezéseket használjon.

	⚠ VIGYÁZAT
	<p>Éles szélek! Vágási sérülések</p> <ul style="list-style-type: none"> ▶ Viseljen védőkesztyűt.

	⚠ FIGYELMEZTETÉS
	<p>Megdöntött készülékek elcsúszása! Csonttörés / zúzódási sérülések</p> <ul style="list-style-type: none"> ▶ Biztosítsa a készülékeket elcsúszás ellen.



	⚠ VIGYÁZAT
	<p>Leeső alkatrészek veszélye a kioldott csavarok miatt! Leeső alkatrészek miatti sérülés.</p> <ul style="list-style-type: none"> ▶ Biztosítsa az alkatrészt leesés ellen.

	FIGYELEM!
	<p>Leeső alkatrészek veszélye a kioldott csavarok miatt! A készülék többi részeinek vagy az ügyfél lakásának (pl. padló) károsodása.</p> <ul style="list-style-type: none"> ▶ Biztosítsa az alkatrészt leesés ellen.

	⚠ VESZÉLY
	<p>Áramütés veszélye áram alatt lévő alkatrészek miatt! Életveszély a nem megfelelő javítás okozta áramütés miatt</p> <ul style="list-style-type: none"> ▶ Az elektromos alkatrészek javítását kizárólag képzett elektroműszerész végezheti. ▶ A javítás után végeztesse a VDE 0701-nek vagy az országspecifikus szabályozásoknak megfelelő vizsgálatot.

	⚠ VESZÉLY
	<p>Áramütés veszélye áram alatt lévő alkatrészek miatt! Halálos áramütés</p> <ul style="list-style-type: none"> ▶ A javítás megkezdése előtt legalább 60 másodperccel válassza le a készülékeket az elektromos hálózatról.

Követelmény:

-  A készüléket leválasztotta az áramellátásról.
-  Eltávolította a készülék belső szerelvényeit.

4.4.1 A felső ajtózsanér eltávolítása

1. Fordítsa a készüléket a hátára.

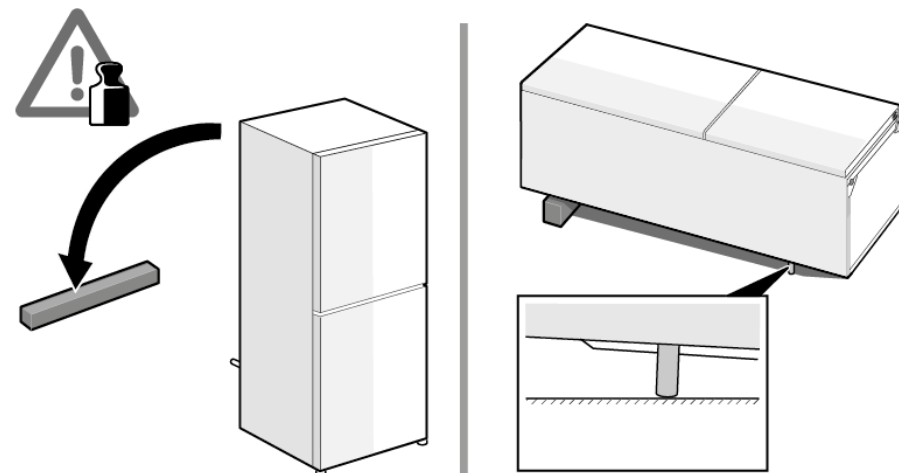

2. 1. Távolítsa el a felső zsanér burkolatát (1).
2. Távolítsa el a kábeldoboz fedelét (2).
3. Válassza le az elektromos csatlakozást (3).
4. Csavarja ki a földelő csatlakozás csavarját (4).
5. Távolítsa el a kábelburkolatot (5).
6. Csavarja ki a csavart (6).

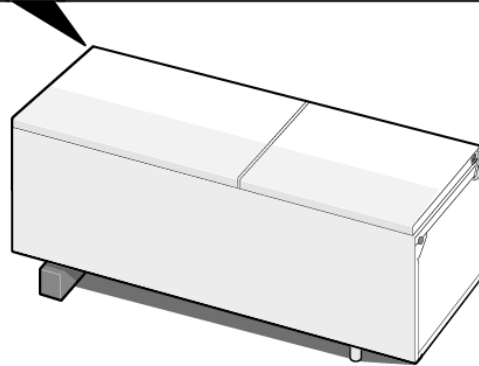
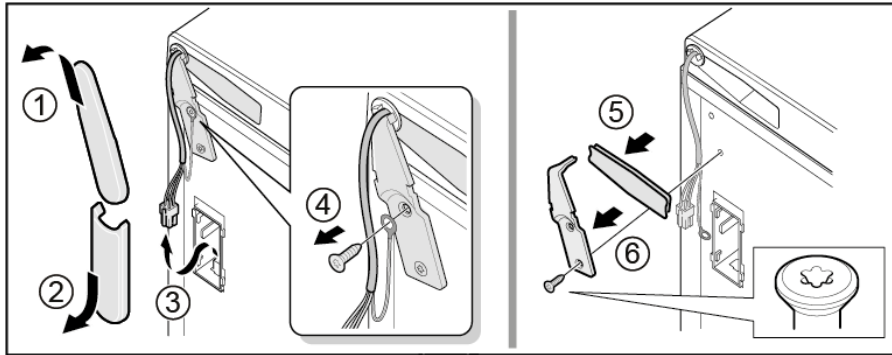

 Eltávolította a felső zsanért.

4.4.2 A felső ajtózsánér felhelyezése

- ▶ Az elhelyezést fordított sorrendben végezze.

4.5 A középső ajtózsanér cseréje

Különleges eszközök

TX20 Torx bithegy

6,3 mm (1/4")

[00340865]



FIGYELMEZTETÉS

Nehéz, nagy készülékek!

Hát- és izomsérülések

- ▶ A készülék ajtajának eltávolítását kizárólag szakemberrel végeztesse.
- ▶ A készülék elmozdításához két emberre van szükség.
- ▶ Kizárólag megfelelő eszközöket és berendezéseket használjon.



VIGYÁZAT

Éles szélek!

Vágási sérülések

- ▶ Viseljen védőkesztyűt.



FIGYELMEZTETÉS

Megdöntött készülékek elcsúszása!

Csonttörés / zúzódási sérülések

- ▶ Biztosítsa a készülékeket elcsúszás ellen.



VIGYÁZAT

Leeső alkatrészek veszélye a kioldott csavarok miatt!

Leeső alkatrészek miatti sérülés.

- ▶ Biztosítsa az alkatrészt leesés ellen.



FIGYELEM!

Leeső alkatrészek veszélye a kioldott csavarok miatt!

A készülék többi részeinek vagy az ügyfél lakásának (pl. padló) károsodása.

- ▶ Biztosítsa az alkatrészt leesés ellen.

Követelmény:

- ✓ A készüléket leválasztotta az áramellátásról.
- ✓ Eltávolította a készülék belső szerelvényeit.
- ✓ Eltávolította az ajtó felső zsanérját.

4.5.1 A középső ajtózsanér eltávolítása

- ▶ 1. Távolítsa el a hűtőrekesz ajtaját (1).
- ▶ 2. Csavarja ki a két csavart (2).
- ▶ 3. Távolítsa el a középső zsanért (3).

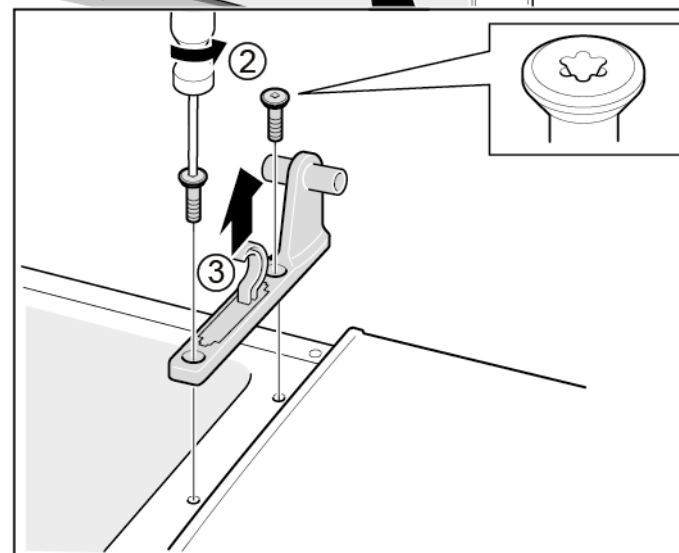
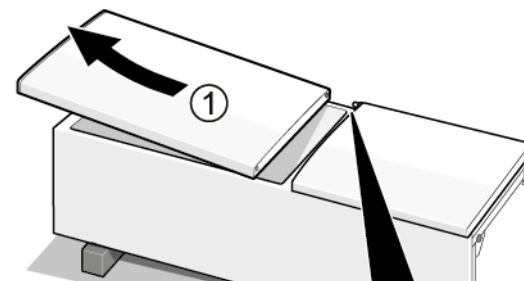

➡ Eltávolította a középső zsanért.

4.5.2 A középső ajtózsanér felhelyezése

- ▶ Az elhelyezést fordított sorrendben végezze.

4.6 Az alsó ajtózanér cseréje

Különleges eszközök

TX20 Torx bithegy

6,3 mm (1/4")

[00340865]

	⚠ FIGYELMEZTETÉS
Nehéz, nagy készülékek!	
Hát- és izomsérülések	
<ul style="list-style-type: none"> ▶ A készülék ajtajának eltávolítását kizárólag szakemberrel végeztesse. ▶ A készülék elmozdításához két emberre van szükség. ▶ Kizárólag megfelelő eszközöket és berendezéseket használjon. 	

	⚠ VIGYÁZAT
Éles szélek!	
Vágási sérülések	
<ul style="list-style-type: none"> ▶ Viseljen védőkesztyűt. 	

	⚠ FIGYELMEZTETÉS
Megdöntött készülékek elcsúszása!	
Csonttörés / zúzódási sérülések	
<ul style="list-style-type: none"> ▶ Biztosítsa a készülékeket elcsúszás ellen. 	

	⚠ VIGYÁZAT
Leeső alkatrészek veszélye a kioldott csavarok miatt!	
Leeső alkatrészek miatti sérülés.	
<ul style="list-style-type: none"> ▶ Biztosítsa az alkatrészt leesés ellen. 	

	FIGYELEM!
Leeső alkatrészek veszélye a kioldott csavarok miatt!	
A készülék többi részeinek vagy az ügyfél lakásának (pl. padló) károsodása.	
<ul style="list-style-type: none"> ▶ Biztosítsa az alkatrészt leesés ellen. 	

Követelmény:

- ✔ A készüléket leválasztotta az áramellátásról.
- ✔ Eltávolította a készülék belső szerelvényeit.
- ✔ Eltávolította a felső zsanért.

- ✔ Eltávolította a középső zsanért.

4.6.1 Az alsó ajtózanér eltávolítása

- ▶ 1. Távolítsa el a fagyasztórekesz ajtaját (1).
- ▶ 2. Csavarja ki a csavart (2).
- ▶ 3. Fordítsa ki az alsó zsanért (3).
- ▶ 4. Távolítsa el az alsó zsanért (4).

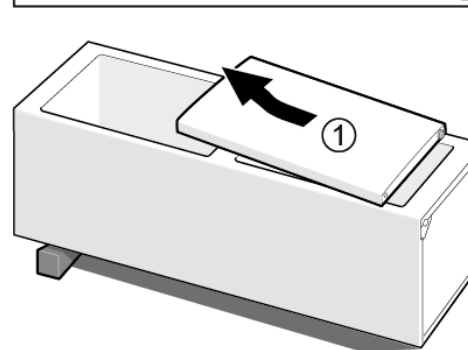
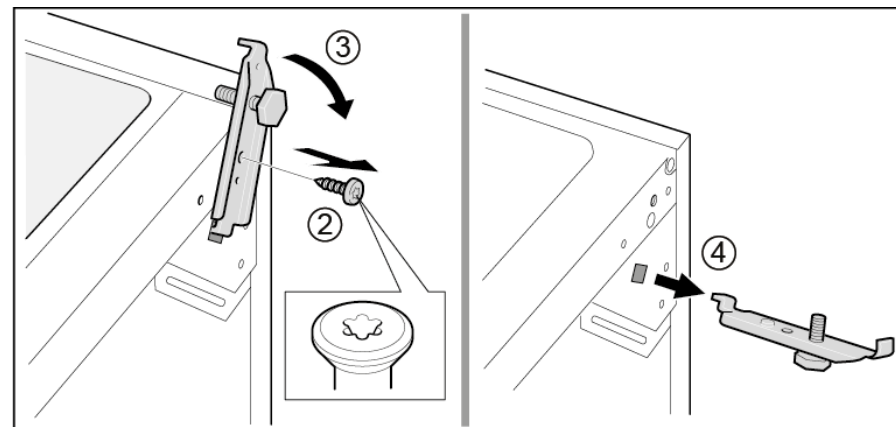

- ➡ Eltávolította az alsó ajtózanért.

4.6.2 Az alsó ajtózanér felhelyezése

- ▶ Az elhelyezést fordított sorrendben végezze.

4.7 A polc cseréje

Követelmény:

- ✔ Az ajtó nyitva van

4.7.1 A polc eltávolítása

- ▶ Húzza ki a polcot.

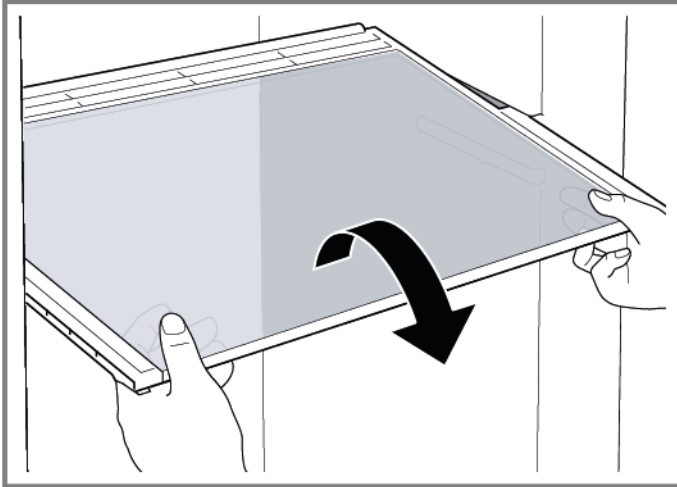

- ➡ Eltávolította a polcot.

4.7.2 A polc beszerelése

- ▶ Az elhelyezést fordított sorrendben végezze.

4.8 A palacktartó cseréje

Követelmény:

- ✔ Az ajtó nyitva van

4.8.1 A palacktartó eltávolítása

- ▶ Húzza ki a palacktartót.

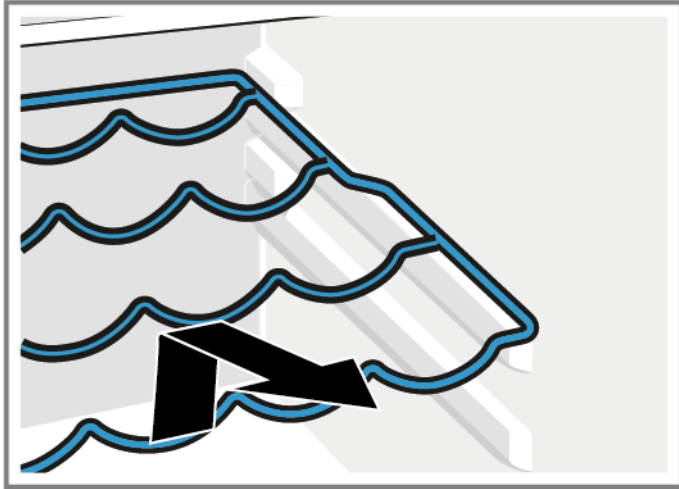

- ➡ Eltávolította a palacktartót.

4.8.2 A palacktartó telepítése

- ▶ Az elhelyezést fordított sorrendben végezze.

4.9 Az ajtópolc cseréje

Követelmény:

- ✔ Az ajtó nyitva van

4.9.1 Az ajtópolc eltávolítása

- ▶ Emelje fel az ajtópolcot.



- ➡ Eltávolította az ajtópolcot.

4.9.2 Az ajtópolc felhelyezése

- ▶ Az elhelyezést fordított sorrendben végezze.

4.10 Az állítható ajtópolc cseréje

Követelmény:

- ✔ Az ajtó nyitva van

4.10.1 Az állítható ajtópolc eltávolítása

- ▶ Emelje az állítható ajtópolcot addig, amíg ki nem oldódik a tartóból.

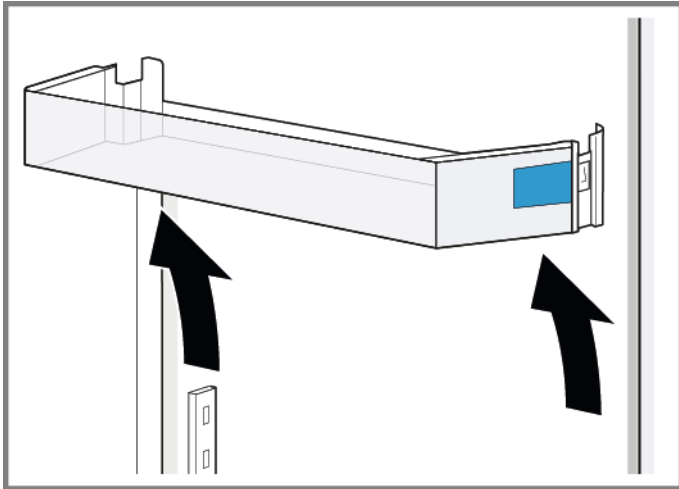

- ➡ Eltávolította az állítható ajtópolcot.

4.10.2 Az állítható ajtópolc behelyezése

- ▶ Az elhelyezést fordított sorrendben végezze.

4.11 Fagyasztódoboz cseréje

Követelmény:

- ✔ Az ajtó nyitva van

4.11.1 Fagyasztódoboz eltávolítása

- ▶ 1. Húzza ki teljesen a fagyasztódobozt (1).
- ▶ 2. Távolítsa el a fagyasztódobozt (2).

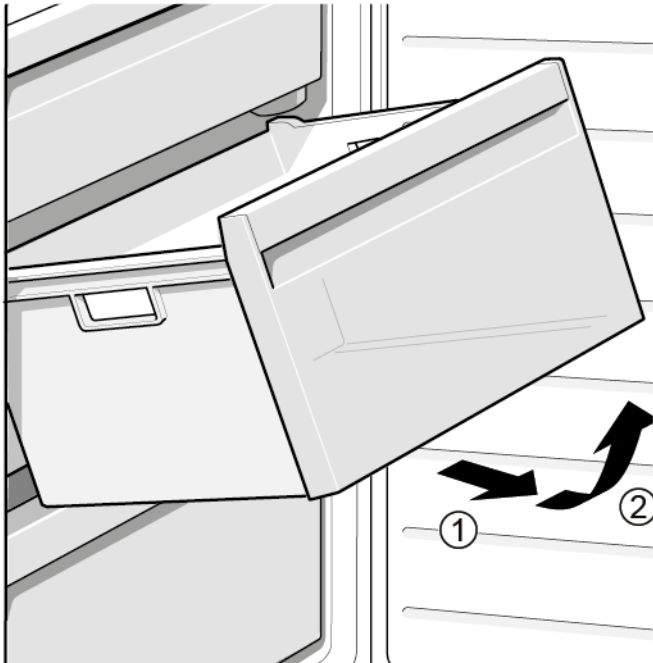

- ➡ Eltávolította a fagyasztódobozt.

4.11.2 A fagyasztódoboz behelyezése

- ▶ Az elhelyezést fordított sorrendben végezze.

4.12 Tároló cseréje

Követelmény:

- ✔ Az ajtó nyitva van

4.12.1 Tároló eltávolítása

- ▶ 1. Húzza ki az alsó tárolót (1).
- ▶ 2. Húzza ki a felső tárolót (2).

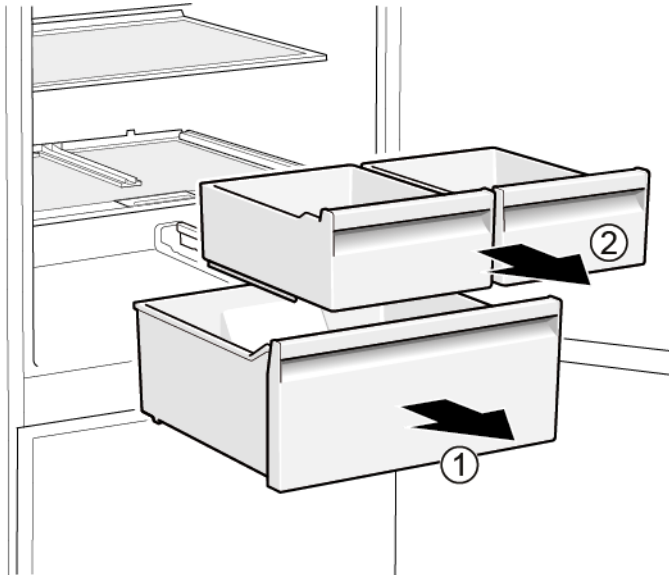

- ➡ Eltávolította a tárolókat.

4.12.2 A tároló behelyezése

- ▶ Az elhelyezést fordított sorrendben végezze.

4.13 A kihúzható tároló cseréje

Követelmény:

- ✔ Az ajtó nyitva van

4.13.1 A kihúzható tároló eltávolítása

- ▶ 1. Húzza ki teljesen a kihúzható tárolót (1).
- ▶ 2. Távolítsa el a kihúzható tárolót (2).

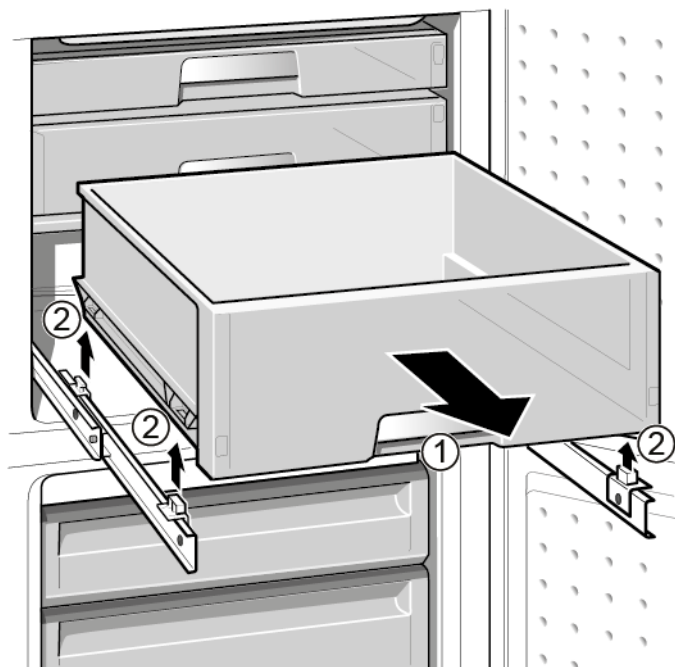

- ➡ Eltávolította a kihúzható tárolót.

4.13.2 A kihúzható tároló behelyezése

- ▶ Az elhelyezést fordított sorrendben végezze.

4.14 LED-es oldalsó spotvilágítás cseréje

Különleges eszközök

Különleges szerszám [00342180]



A készüléke karbantartásmentes LED-világítással rendelkezik.
A világítást kizárólag az ügyfélszolgálat vagy szakképzett technikusok javíthatják meg!



⚠ VESZÉLY

Áramütés veszélye áram alatt lévő alkatrészek miatt!

Életveszély a nem megfelelő javítás okozta áramütés miatt

- ▶ Az elektromos alkatrészek javítását kizárólag képzett elektroműszerész végezheti.
- ▶ A javítás után végeztesen a VDE 0701-nek vagy az országspecifikus szabályozásoknak megfelelő vizsgálatot.



⚠ VESZÉLY

Áramütés veszélye áram alatt lévő alkatrészek miatt!

Halálos áramütés

- ▶ A javítás megkezdése előtt legalább 60 másodperccel válassza le a készülékeket az elektromos hálózatról.



⚠ VIGYÁZAT

Éles szélek!

Vágási sérülések

- ▶ Viseljen védőkesztyűt.

Követelmény:

- ✓ A készüléket leválasztotta az áramellátásról.
- ✓ Az ajtó nyitva van

4.14.1 LED-es spotvilágítás eltávolítása

1. Speciális szerszámmal húzza ki a LED-es spotvilágítást (1).

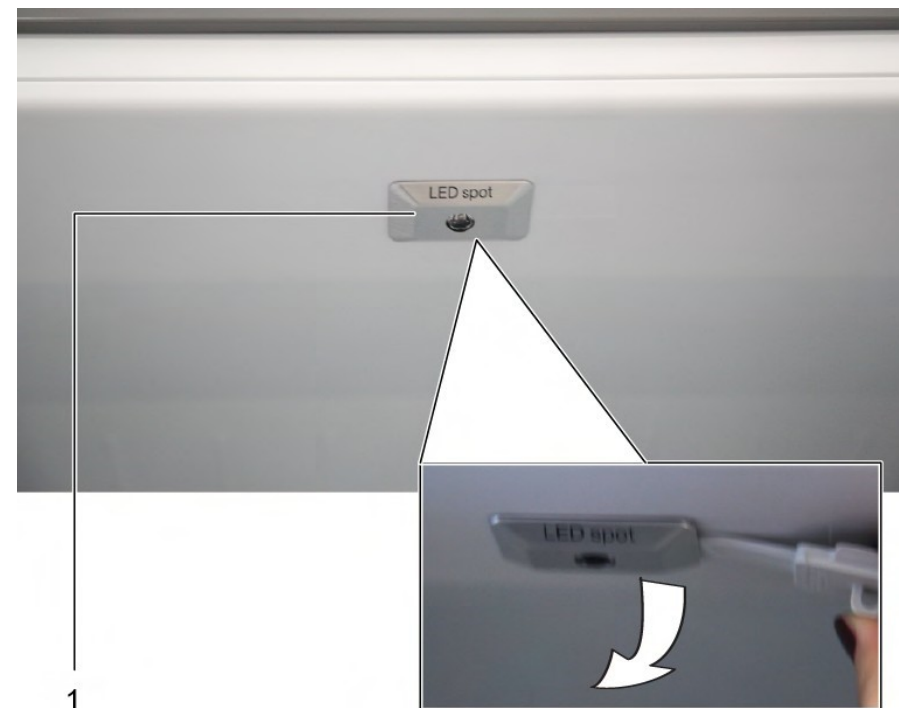

2. Válassza le a LED-es spotvilágítás elektromos csatlakozóit.
➔ Eltávolította a LED-es spotvilágítást.

4.14.2 A LED-es spotvilágítás beszerelése

- ▶ Az elhelyezést fordított sorrendben végezze.

4.15 Felső LED-világítás cseréje

Különleges eszközök

-  Laposfejű csavarhúzó Hegy 2,4 mm x 0,4 mm x 60 mm, a készletben [00341820]

 A készüléke karbantartásmentes LED-világítással rendelkezik. A világítást kizárólag az ügyfélszolgálat vagy szakképzett technikusok javíthatják meg!

 **⚠ VESZÉLY**
Áramütés veszélye áram alatt lévő alkatrészek miatt!
 Életveszély a nem megfelelő javítás okozta áramütés miatt

- ▶ Az elektromos alkatrészek javítását kizárólag képzett elektroműszerész végezheti.
- ▶ A javítás után végeztesen a VDE 0701-nek vagy az országspecifikus szabályozásoknak megfelelő vizsgálatot.



 **⚠ VESZÉLY**
Áramütés veszélye áram alatt lévő alkatrészek miatt!
 Halálos áramütés

- ▶ A javítás megkezdése előtt legalább 60 másodperccel válassza le a készülékeket az elektromos hálózatról.

 **⚠ VIGYÁZAT**
Éles szélek!
 Vágási sérülések

- ▶ Viseljen védőkesztyűt.

Követelmény:

-  A készüléket leválasztotta az áramellátásról.
-  Az ajtó nyitva van
-  Eltávolította a készülék felső szerelvényeit.

4.15.1 LED-világítás eltávolítása

1. Vigye a LED-világítást a bal oldalra.



-  Leválasztotta a LED-világítás elektromos csatlakozását.

2. Oldja ki a LED-világításhoz kapcsolódó horgokat.

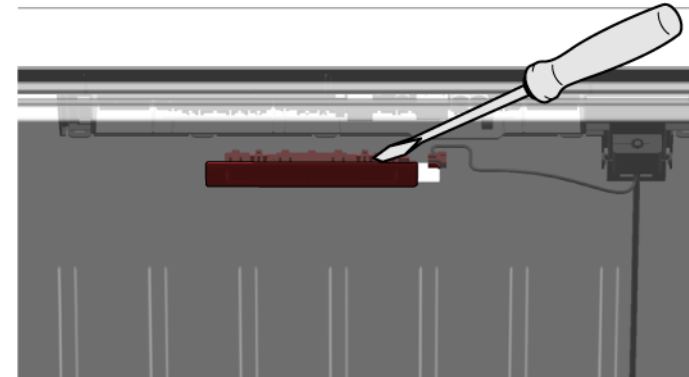

3. Emelje el a készüléktől a LED-világítást.

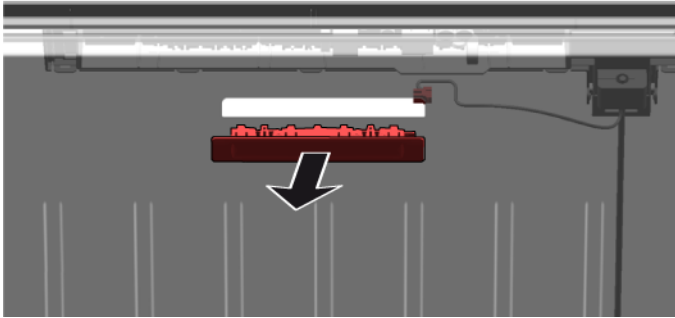

- ➔ Eltávolította a LED-világítást.

4.15.2 A felső LED-világítás beszerelése

- ▶ Az elhelyezést fordított sorrendben végezze.

4.16 A LED-es oldalvilágítás cseréje

Különleges eszközök

Tapadókorong Ø50 mm [00342224]



A készüléke karbantartásmentes LED-világítással rendelkezik.
A világítást kizárólag az ügyfélszolgálat vagy szakképzett technikusok javíthatják meg!



⚠ VESZÉLY

Áramütés veszélye áram alatt lévő alkatrészek miatt!

Életveszély a nem megfelelő javítás okozta áramütés miatt

- ▶ Az elektromos alkatrészek javítását kizárólag képzett elektroműszerész végezheti.
- ▶ A javítás után végeztesen a VDE 0701-nek vagy az országspecifikus szabályozásoknak megfelelő vizsgálatot.



⚠ VESZÉLY

Áramütés veszélye áram alatt lévő alkatrészek miatt!

Halálos áramütés

- ▶ A javítás megkezdése előtt legalább 60 másodperccel válassza le a készülékeket az elektromos hálózatról.



⚠ VIGYÁZAT

Éles szélek!

Vágási sérülések

- ▶ Viseljen védőkesztyűt.

Követelmény:

- ✓ A készüléket leválasztotta az áramellátásról.
- ✓ Az ajtó nyitva van
- ✓ Eltávolította a hűtőszekrény polcait.

4.16.1 LED-es oldalvilágítás eltávolítása

1. Nyomja a tapadókorongot a LED-es oldalvilágítás felső harmadára.



2. Húzza maga felé a tapadókorongot a LED-es oldalvilágítással együtt egyetlen forgó mozdulattal.

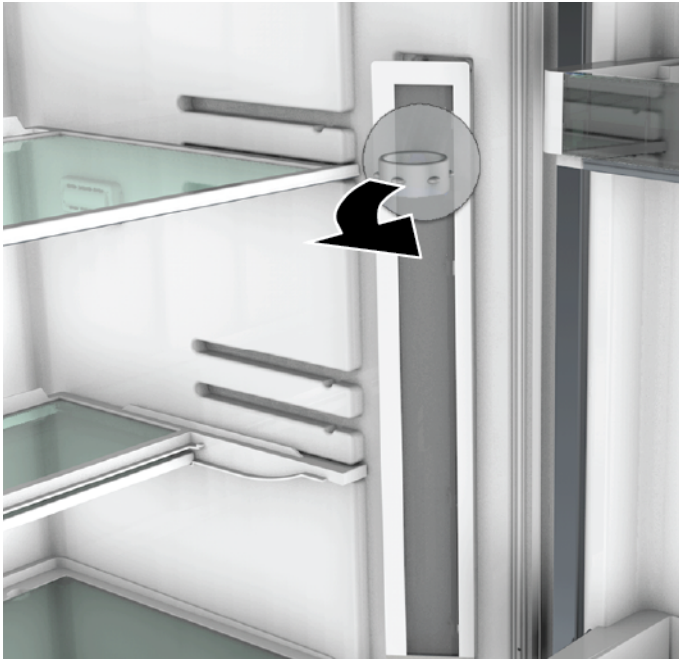



3. Válassza le az elektromos csatlakozást a LED-es oldalvilágításról.
➡ Eltávolította a LED-es oldalvilágítást.

4.16.2 A LED-es oldalvilágítás beszerelése

1. Csatlakoztassa az elektromos csatlakozást a LED-es oldalvilágításhoz.
 2. Rögzítse a LED-es oldalvilágítást a helyére a rekeszfalon (kattanó hang).
- ➡ Beszerelte a LED-es oldalvilágítást.

4.17 LED-es oldalsó spotvilágítás cseréje

Különleges eszközök

-  Különleges szerszám [00342180]
-  Laposfejű csavarhúzó Hegy 2,4 mm x 0,4 mm x 60 mm, a készletben [00341820]

 A készüléke karbantartásmentes LED-világítással rendelkezik. A világítást kizárólag az ügyfélszolgálat vagy szakképzett technikusok javíthatják meg!

 **⚠ VESZÉLY**
Áramütés veszélye áram alatt lévő alkatrészek miatt!
 Életveszély a nem megfelelő javítás okozta áramütés miatt

- ▶ Az elektromos alkatrészek javítását kizárólag képzett elektroműszerész végezheti.
- ▶ A javítás után végeztesen a VDE 0701-nek vagy az országspecifikus szabályozásoknak megfelelő vizsgálatot.



 **⚠ VESZÉLY**
Áramütés veszélye áram alatt lévő alkatrészek miatt!
 Halálos áramütés

- ▶ A javítás megkezdése előtt legalább 60 másodperccel válassza le a készülékeket az elektromos hálózatról.

 **⚠ VIGYÁZAT**
Éles szélek!
 Vágási sérülések

- ▶ Viseljen védőkesztyűt.

Követelmény:

-  A készüléket leválasztotta az áramellátásról.
-  Az ajtó nyitva van
-  Eltávolította a hűtőszekrény polcait.

4.17.1 LED-es spotvilágítás eltávolítása

1. Oldja ki a LED-es spotvilágítás burkolatát.

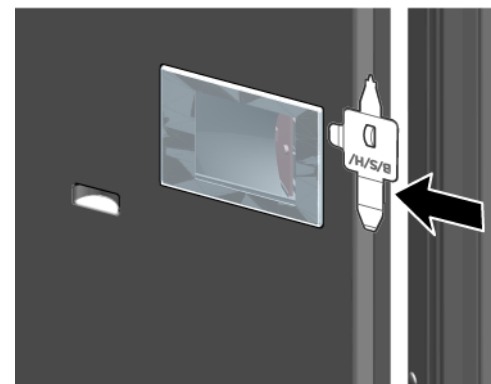

2. Húzza befelé a LED-es spotvilágítás burkolatát, és ezzel egyidejűleg tolja előre.

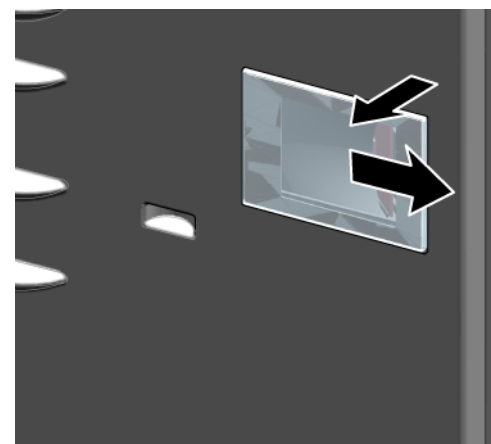

3. Válassza le a LED-es spotvilágítás modulját.

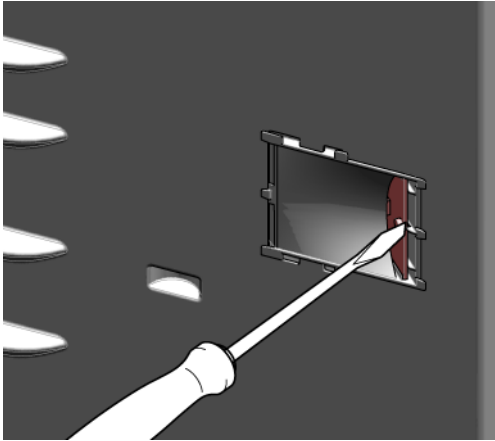

4. Válassza le a LED-es spotvilágítás elektromos csatlakozását.

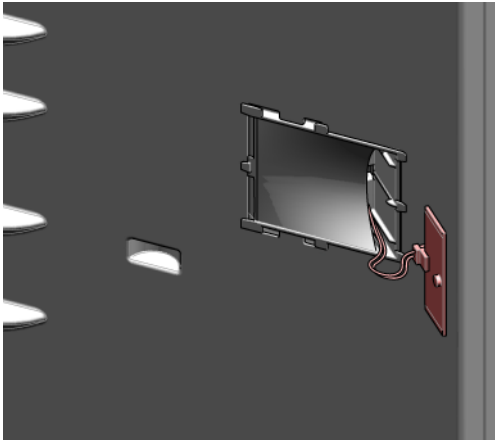

- ➔ Eltávolította a LED-es spotvilágítást.

4.17.2 A LED-es spotvilágítás beszerelése

- ▶ Az elhelyezést fordított sorrendben végezze.

Consigli di riparazione - Combinazione frigorifero / congelatore

 Utilizzo del documento	351
1.1 Avvertenze importanti	351
1.1.1 Scopo	351
1.2 Spiegazione dei simboli	351
1.2.1 Livelli di pericolo	351
1.2.2 Simboli di pericolo	351
1.2.3 Struttura degli avvertimenti	352
1.2.4 Simboli generici	352
 Sicurezza	353
2.1 Note generali sulla sicurezza	353
2.1.1 Tutti gli elettrodomestici	353
 Strumenti e ausili	354
 Riparazione	355
4.1 Sostituzione della guarnizione della porta	355
4.1.1 Smontaggio della guarnizione della porta	355
4.1.2 Montaggio della guarnizione della porta	355
4.2 Sostituzione della maniglia della porta	358
4.2.1 Smontaggio della maniglia della porta	358
4.2.2 Montaggio della maniglia della porta	358
4.3 Sostituzione della cerniera superiore della porta	359
4.3.1 Smontaggio della cerniera superiore della porta	359
4.3.2 Montaggio della cerniera superiore della porta	360
4.4 Sostituzione della cerniera superiore della porta (porta con display)	361
4.4.1 Smontaggio della cerniera superiore della porta	361
4.4.2 Montaggio della cerniera superiore della porta	362
4.5 Sostituzione della cerniera centrale della porta	363
4.5.1 Smontaggio della cerniera centrale della porta	363
4.5.2 Montaggio della cerniera centrale della porta	363
4.6 Sostituzione della cerniera inferiore della porta	364
4.6.1 Smontaggio della cerniera inferiore della porta	364
4.6.2 Montaggio della cerniera inferiore della porta	364
4.7 Sostituzione del ripiano	365
4.7.1 Smontaggio del ripiano	365
4.7.2 Montaggio del ripiano	365

4.8 Sostituzione del portabottiglie	366
4.8.1 Smontaggio del portabottiglie	366
4.8.2 Montaggio del portabottiglie	366
4.9 Sostituzione del balconcino della porta	367
4.9.1 Smontaggio del balconcino della porta	367
4.9.2 Montaggio del balconcino della porta	367
4.10 Sostituzione del balconcino della porta regolabile	368
4.10.1 Smontaggio del balconcino della porta regolabile	368
4.10.2 Montaggio del balconcino della porta regolabile	368
4.11 Sostituzione del cassetto surgelati	369
4.11.1 Rimozione del cassetto surgelati	369
4.11.2 Inserimento del cassetto surgelati	369
4.12 Sostituzione del cassetto	370
4.12.1 Estrazione del cassetto	370
4.12.2 Inserimento del cassetto	370
4.13 Sostituzione del cassetto estraibile	371
4.13.1 Rimozione del cassetto estraibile	371
4.13.2 Inserimento del cassetto estraibile	371
4.14 Sostituzione del faretto a LED	372
4.14.1 Smontaggio del faretto a LED	372
4.14.2 Montaggio del faretto a LED	372
4.15 Sostituzione della luce a LED superiore	373
4.15.1 Smontaggio della luce a LED	373
4.15.2 Montaggio della luce a LED superiore	374
4.16 Sostituzione della luce a barra laterale a LED	375
4.16.1 Smontaggio della luce a barra laterale a LED	375
4.16.2 Montaggio della luce a barra laterale a LED	376
4.17 Sostituzione del faretto a LED	377
4.17.1 Smontaggio del faretto a LED	377
4.17.2 Montaggio del faretto a LED	378

i Utilizzo del documento

1.1 Avvertenze importanti

1.1.1 Scopo

Queste istruzioni di riparazione spiegano ai clienti come riparare da soli gli elettrodomestici in conformità alle regole sull'Ecodesign vigenti (al 03/2021).

Contengono informazioni sulla sostituzione di pezzi di ricambio specifici e sulle avvertenze e i rischi correlati.

In caso di domande, contattare l'assistenza tecnica. Il mancato rispetto di tali istruzioni da parte dei clienti ci esonera da qualsiasi responsabilità.

1.2 Spiegazione dei simboli

1.2.1 Livelli di pericolo

I livelli di avvertimento corrispondono a un simbolo accompagnato da una parola di allerta. La parola di allerta identifica il livello di pericolo.







Livello di avvertimento	Significato
	Ignorare questo messaggio di avvertimento comporta rischio di morte o ferite gravi.
	Ignorare questo messaggio di avvertimento può comportare rischio di morte o ferite gravi.
	Ignorare questo messaggio di avvertimento può comportare ferite di minore gravità.
	Ignorare questo messaggio di avvertimento può comportare danni materiali.

Tabella 1: Livelli di pericolo

1.2.2 Simboli di pericolo

I simboli di pericolo sono illustrazioni che specificano la tipologia di rischio.

Nella presente documentazione vengono utilizzati i seguenti simboli di pericolo:

Simbolo di pericolo	Significato
	Messaggio di avvertimento generico
	Pericolo di scossa elettrica
	Pericolo di esplosione
	Rischio di ferite da taglio

i Utilizzo del documento





Simbolo di pericolo	Significato
	Pericolo di schiacciamento
	Pericolo derivante da superfici calde
	Pericolo derivante da forti campi magnetici
	Pericolo derivante da radiazioni non ionizzanti

Tabella 2: Simboli di pericolo

1.2.3 Struttura degli avvertimenti

Gli avvertimenti presenti in questo manuale hanno una forma e una struttura standardizzati.

	<p>PERICOLO</p> <p>Tipo e origine del pericolo! Possibili conseguenze in caso di pericolo/avvertimento ignorato.</p> <ul style="list-style-type: none"> ▶ Misure e divieti volti a prevenire il pericolo.
--	--

L'esempio seguente mostra un avvertimento con rischio di folgorazione dovuto a componenti sotto tensione. È riportata la misura di precauzione per evitare il pericolo.

	<p>PERICOLO</p> <p>Rischio di scossa elettrica dovuto a componenti sotto tensione! Morte per folgorazione</p> <ul style="list-style-type: none"> ▶ Scollegare l'apparecchio dall'alimentazione per almeno 60 secondi prima di iniziare la riparazione.
--	---

1.2.4 Simboli generici

Nel presente manuale vengono utilizzati i seguenti simboli generici:





Simbolo generico	Significato
	Identificazione di un suggerimento speciale (testo e/o grafica)
	Identificazione di un suggerimento semplice (solo testo)
	Identificazione di un link per un video tutorial
	Identificazione degli strumenti necessari
	Identificazione delle condizioni preve necessarie
	Identificazione di una condizione (se ..., allora ...)
	Identificazione di un risultato
[Avvio]	Identificazione di un tasto o di un pulsante
[00123456]	Identificazione di un codice articolo
Stato	Identificazione di un testo/finestra visualizzati (sul display dell'apparecchio)

Tabella 3: Simboli generici

2.1 Note generali sulla sicurezza

2.1.1 Tutti gli elettrodomestici

Rischio di scosse elettriche dovute a componenti sotto tensione!

- La riparazione non conforme dei componenti elettrici può causare scosse elettriche!
- Scollegare l'apparecchio dall'alimentazione per almeno 60 secondi prima di iniziare il lavoro.
- Ultimata la riparazione, occorre eseguire un test di sicurezza conforme alla norma VDE 0701 o alle norme specifiche del Paese.

Rischio di lesioni causate da bordi taglienti!

- Indossare guanti di protezione.

Rischio di schiacciamento dovuto a componenti pesanti e in movimento durante la riparazione, la manutenzione, la ricerca dei guasti e l'assistenza

- Indossare calzature antinfortunistiche.
- Fissare i componenti pesanti per impedire che cadano.
- Non inserire parti del corpo nei componenti in movimento.





Rischio per il funzionamento o la sicurezza dell'apparecchio!

- Utilizzare solo ricambi originali.

Rischio di danneggiamento di componenti sensibili a carica elettrostatica (ESD)!

- Non toccare i moduli, inclusi i collegamenti e le piste conduttive.

Strumenti e ausili

Designazione	Dettagli	Immagini
Panno di protezione [00342013]	60 cm x 50 cm	
Cacciavite a taglio	Lama 2,4 mm x 0,4 mm x 60 mm, nel kit [00341820]	
Utensile speciale [00342180]		
Ventosa [00342224]	Ø50 mm	
Punta Torx TX20 [00340865]	6,3 mm (1/4")	
Cacciavite a taglio	Lama 10 mm x 1,6 mm x 200 mm	

4.1 Sostituzione della guarnizione della porta

Prerequisiti:

- ✔ La porta è aperta.

4.1.1 Smontaggio della guarnizione della porta

1. Staccare la guarnizione della porta dalla scanalatura negli angoli destro e sinistro.





2. Estrarre la guarnizione della porta dalla scanalatura.



- ➡ La guarnizione della porta è rimossa.

4.1.2 Montaggio della guarnizione della porta

	Lo spessore della nuova guarnizione della porta può essere leggermente diverso dallo spessore di quella vecchia. Ciò non incide sulla chiusura e sul funzionamento a lungo termine.
	Se l'apparecchio è dotato di cerniere regolabili o accessori, è possibile ottimizzare il comportamento di chiusura.
	I piccoli fori laterali nella guarnizione della porta sono funzionali (necessari per la ventilazione). Non si tratta di difetti di produzione.

Riparazione

1. Controllare che la scanalatura della guarnizione non sia danneggiata.

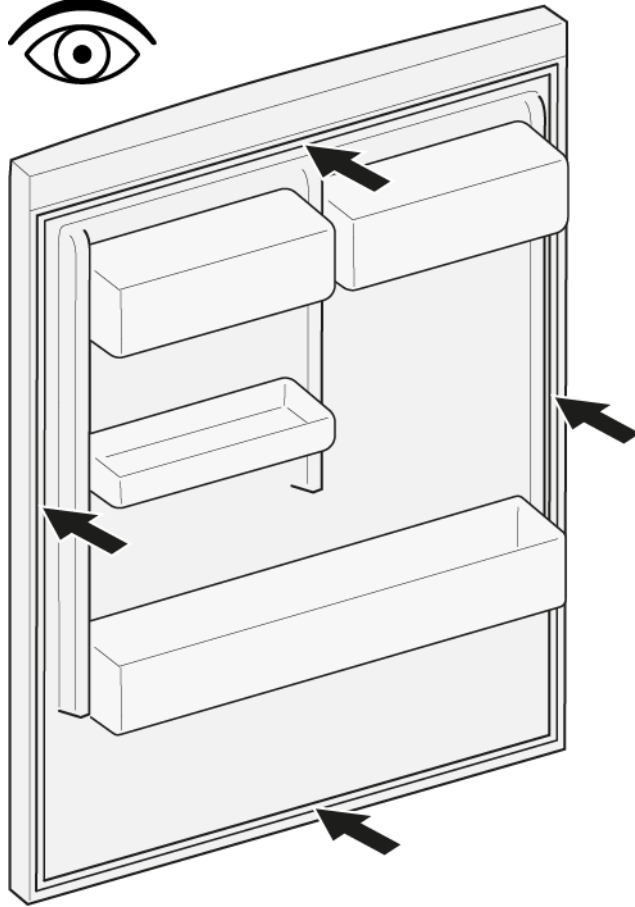

4. Spingere gli angoli della guarnizione nella scanalatura in alto e in basso.

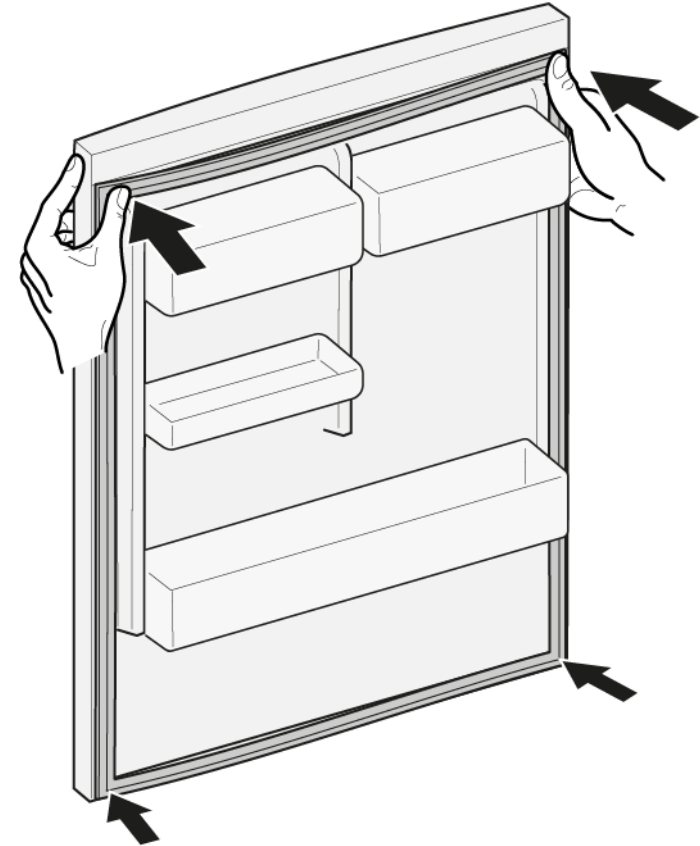

2.  Se la scanalatura della guarnizione è danneggiata.
- Contattare l'assistenza tecnica.

3.  Una leggera deformazione della guarnizione della porta è normale e non incide sul funzionamento. Si consiglia di raddrizzare la guarnizione della porta prima di inserirla nell'apparecchio.

Riscaldare la guarnizione della porta con un asciugacapelli o acqua calda e ridarle la forma manualmente.

Riparazione



5. Premere la guarnizione nella scanalatura un pezzo per volta.





-  La guarnizione della porta è montata.

4.2 Sostituzione della maniglia della porta

Attrezzi speciali:

-  Punta Torx TX20 6,3 mm (1/4") [00340865]
-  Cacciavite a taglio Lama 10 mm x 1,6 mm x 200 mm

Prerequisiti:

-  L'apparecchio è scollegato dalla rete elettrica.
-  La porta è aperta.

4.2.1 Smontaggio della maniglia della porta

- ▶ 1. Togliere i due tappi delle viti (1).
- ▶ 2. Svitare le due viti (2).
- ▶ 3. Smontare la maniglia della porta (3).

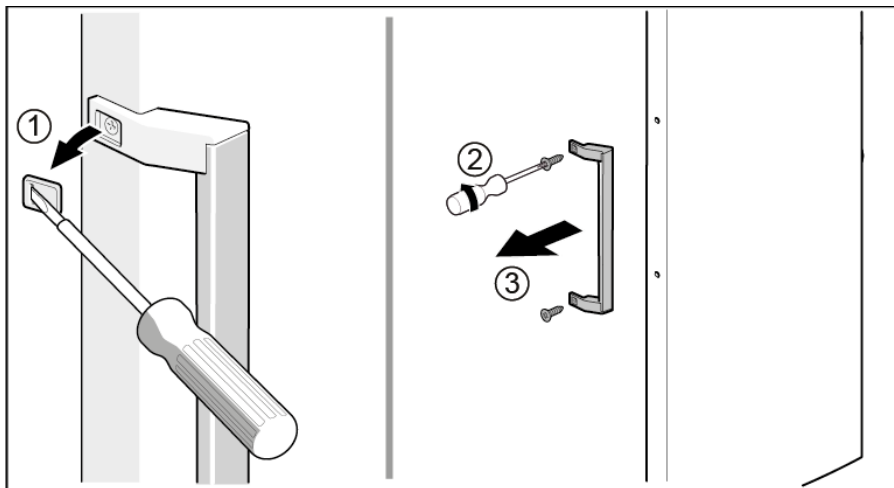

 La maniglia della porta è rimossa.



La maniglia della seconda porta può essere rimossa nello stesso modo.

4.2.2 Montaggio della maniglia della porta

- ▶ Per il montaggio, seguire la procedura sopra descritta in senso opposto.

4.3 Sostituzione della cerniera superiore della porta

Attrezzi speciali:

🔧 Punta Torx TX20 6,3 mm (1/4") [00340865]

	<p style="text-align: center;">⚠️ AVVERTENZA</p> <p>Apparecchi pesanti, ingombranti! Rischio di infortuni muscolari e alla schiena</p> <ul style="list-style-type: none"> ▶ L'operazione di smontaggio della porta dell'apparecchio deve essere eseguita soltanto da tecnici addestrati. ▶ Spostare l'apparecchio in due persone. ▶ Usare solo utensili e attrezzature idonei.
	<p style="text-align: center;">⚠️ ATTENZIONE</p> <p>Bordi taglienti! Ferite da taglio</p> <ul style="list-style-type: none"> ▶ Indossare guanti di protezione.
	<p style="text-align: center;">⚠️ AVVERTENZA</p> <p>Gli apparecchi inclinati possono scivolare! Fratture / lesioni da schiacciamento</p> <ul style="list-style-type: none"> ▶ Fissare gli apparecchi in modo che non scivolino.
	<p style="text-align: center;">⚠️ ATTENZIONE</p> <p>Rischio di caduta di componenti a causa di viti allentate! Lesioni provocate dalla caduta di componenti.</p> <ul style="list-style-type: none"> ▶ Fissare i componenti in modo che non cadano.
	<p style="text-align: center;">ATTENZIONE!</p> <p>Rischio di caduta di componenti a causa di viti allentate! Danni a altre parti dell'apparecchio o all'abitazione del cliente, ad es. parte inferiore.</p> <ul style="list-style-type: none"> ▶ Fissare i componenti in modo che non cadano.

Prerequisiti:

- ✔ L'apparecchio è scollegato dalla rete elettrica.
- ✔ Gli accessori interni dell'apparecchio sono stati rimossi.

4.3.1 Smontaggio della cerniera superiore della porta

1. Coricare l'apparecchio sul retro.

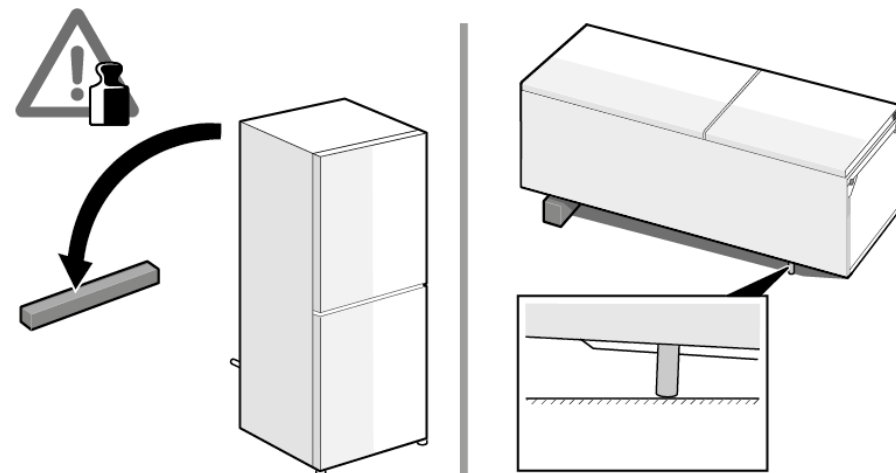

Riparazione

2. 1. Premere la copertura della cerniera superiore su entrambi i lati (1).
2. Tirare la copertura della cerniera superiore verso l'esterno (2).
3. Ruotare la copertura della cerniera (3).
4. Togliere la copertura superiore della cerniera (4).
5. Svitare le due viti (5).
6. Togliere la cerniera superiore (6)

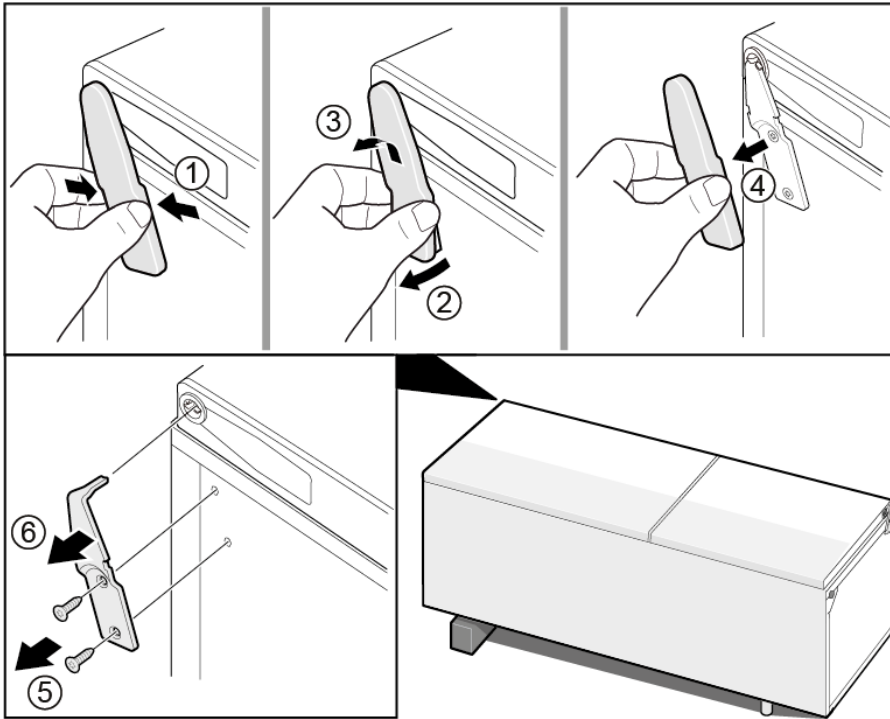

 La cerniera superiore è rimossa.

4.3.2 Montaggio della cerniera superiore della porta

- ▶ Per il montaggio, seguire la procedura sopra descritta in senso opposto.

4.4 Sostituzione della cerniera superiore della porta (porta con display)

Attrezzi speciali:

 Punta Torx TX20 6,3 mm (1/4") [00340865]

	⚠ AVVERTENZA
	<p>Apparecchi pesanti, ingombranti! Rischio di infortuni muscolari e alla schiena</p> <ul style="list-style-type: none"> ▶ L'operazione di smontaggio della porta dell'apparecchio deve essere eseguita soltanto da tecnici addestrati. ▶ Spostare l'apparecchio in due persone. ▶ Usare solo utensili e attrezzature idonei.

	⚠ ATTENZIONE
	<p>Bordi taglienti! Ferite da taglio</p> <ul style="list-style-type: none"> ▶ Indossare guanti di protezione.

	⚠ AVVERTENZA
	<p>Gli apparecchi inclinati possono scivolare! Fratture / lesioni da schiacciamento</p> <ul style="list-style-type: none"> ▶ Fissare gli apparecchi in modo che non scivolino.



	⚠ ATTENZIONE
	<p>Rischio di caduta di componenti a causa di viti allentate! Lesioni provocate dalla caduta di componenti.</p> <ul style="list-style-type: none"> ▶ Fissare i componenti in modo che non cadano.

	ATTENZIONE!
	<p>Rischio di caduta di componenti a causa di viti allentate! Danni a altre parti dell'apparecchio o all'abitazione del cliente, ad es. parte inferiore.</p> <ul style="list-style-type: none"> ▶ Fissare i componenti in modo che non cadano.

	⚠ PERICOLO
	<p>Rischio di scosse elettriche dovute a componenti sotto tensione! Pericolo di morte dovuto a scosse elettriche in caso di riparazione non conforme</p> <ul style="list-style-type: none"> ▶ Le parti elettriche devono essere riparate da elettricisti qualificati. ▶ Ultimata la riparazione, occorre eseguire un test di sicurezza conforme alla norma VDE 0701 o alle norme specifiche del Paese.

	⚠ PERICOLO
	<p>Rischio di scossa elettrica dovuto a componenti sotto tensione! Morte per folgorazione</p> <ul style="list-style-type: none"> ▶ Scollegare l'apparecchio dall'alimentazione per almeno 60 secondi prima di iniziare la riparazione.

Prerequisiti:

-  L'apparecchio è scollegato dalla rete elettrica.
-  Gli accessori interni dell'apparecchio sono stati rimossi.

4.4.1 Smontaggio della cerniera superiore della porta

1. Coricare l'apparecchio sul retro.

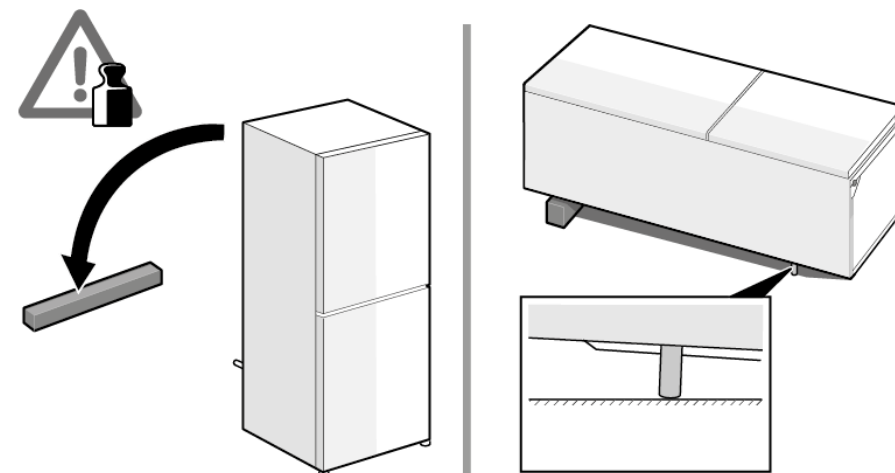

Riparazione

2. 1. Togliere la copertura superiore della cerniera (1).
2. Togliere il coperchio del cavo (2).
3. Staccare il collegamento elettrico (3).
4. Svitare la vite del collegamento di messa a terra (4).
5. Togliere la protezione del cavo (5).
6. Svitare la vite (6).

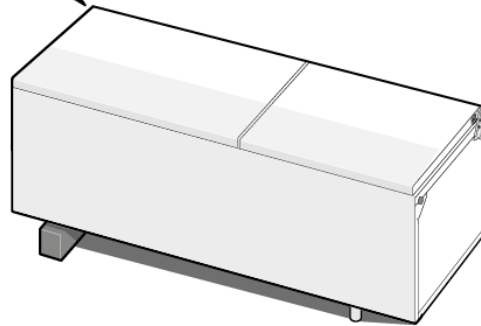
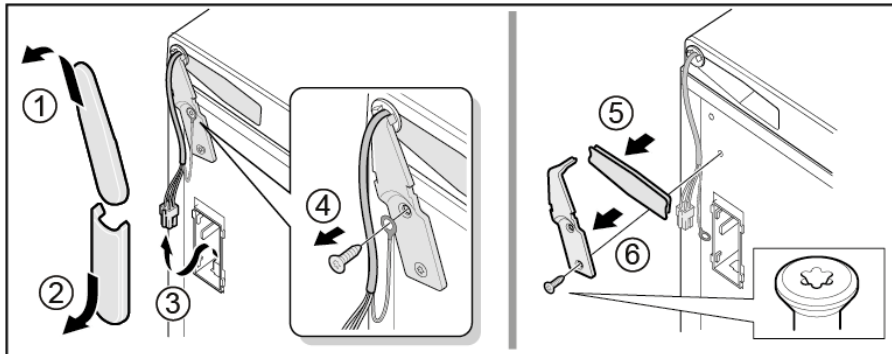

 La cerniera superiore è rimossa.

4.4.2 Montaggio della cerniera superiore della porta

- ▶ Per il montaggio, seguire la procedura sopra descritta in senso opposto.

4.5 Sostituzione della cerniera centrale della porta

Attrezzi speciali:

 Punta Torx TX20 6,3 mm (1/4") [00340865]

	⚠ AVVERTENZA
	<p>Apparecchi pesanti, ingombranti! Rischio di infortuni muscolari e alla schiena</p> <ul style="list-style-type: none"> ▶ L'operazione di smontaggio della porta dell'apparecchio deve essere eseguita soltanto da tecnici addestrati. ▶ Spostare l'apparecchio in due persone. ▶ Usare solo utensili e attrezzature idonei.



	⚠ ATTENZIONE
	<p>Bordi taglienti! Ferite da taglio</p> <ul style="list-style-type: none"> ▶ Indossare guanti di protezione.

	⚠ AVVERTENZA
	<p>Gli apparecchi inclinati possono scivolare! Fratture / lesioni da schiacciamento</p> <ul style="list-style-type: none"> ▶ Fissare gli apparecchi in modo che non scivolino.

	⚠ ATTENZIONE
	<p>Rischio di caduta di componenti a causa di viti allentate! Lesioni provocate dalla caduta di componenti.</p> <ul style="list-style-type: none"> ▶ Fissare i componenti in modo che non cadano.

	ATTENZIONE!
	<p>Rischio di caduta di componenti a causa di viti allentate! Danni a altre parti dell'apparecchio o all'abitazione del cliente, ad es. parte inferiore.</p> <ul style="list-style-type: none"> ▶ Fissare i componenti in modo che non cadano.

Prerequisiti:

-  L'apparecchio è scollegato dalla rete elettrica.
-  Gli accessori interni dell'apparecchio sono stati rimossi.
-  La cerniera superiore della porta è rimossa.

4.5.1 Smontaggio della cerniera centrale della porta

- ▶ 1. Togliere la porta del comparto frigorifero (1).
- ▶ 2. Svitare le due viti (2).
- ▶ 3. Rimuovere la cerniera centrale (3).

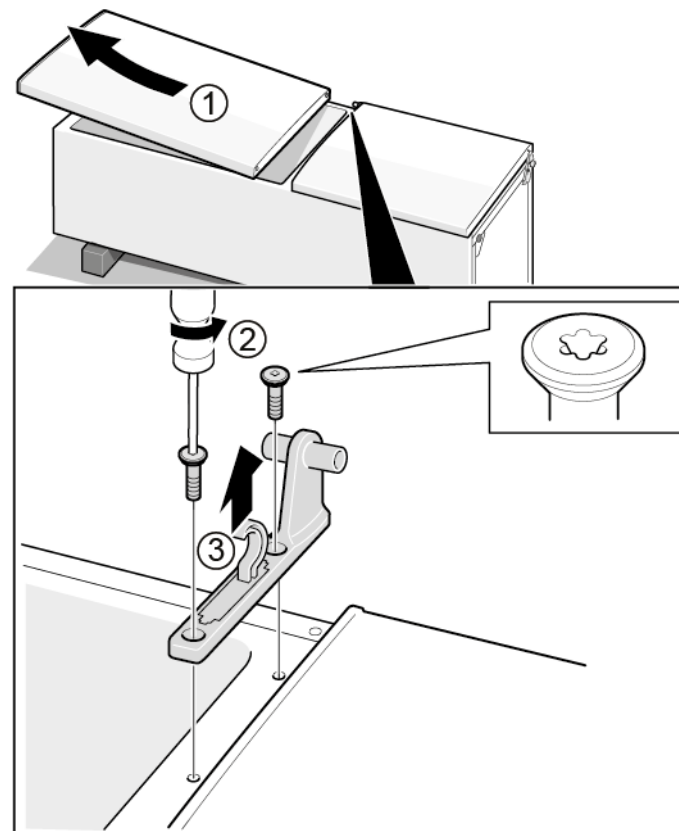

 La cerniera centrale è rimossa.

4.5.2 Montaggio della cerniera centrale della porta

- ▶ Per il montaggio, seguire la procedura sopra descritta in senso opposto.

4.6 Sostituzione della cerniera inferiore della porta

Attrezzi speciali:

🔧 Punta Torx TX20 6,3 mm (1/4") [00340865]

	⚠️ AVVERTENZA
	<p>Apparecchi pesanti, ingombranti! Rischio di infortuni muscolari e alla schiena</p> <ul style="list-style-type: none"> ▶ L'operazione di smontaggio della porta dell'apparecchio deve essere eseguita soltanto da tecnici addestrati. ▶ Spostare l'apparecchio in due persone. ▶ Usare solo utensili e attrezzature idonei.

	⚠️ ATTENZIONE
	<p>Bordi taglienti! Ferite da taglio</p> <ul style="list-style-type: none"> ▶ Indossare guanti di protezione.

	⚠️ AVVERTENZA
	<p>Gli apparecchi inclinati possono scivolare! Fratture / lesioni da schiacciamento</p> <ul style="list-style-type: none"> ▶ Fissare gli apparecchi in modo che non scivolino.

	⚠️ ATTENZIONE
	<p>Rischio di caduta di componenti a causa di viti allentate! Lesioni provocate dalla caduta di componenti.</p> <ul style="list-style-type: none"> ▶ Fissare i componenti in modo che non cadano.

	ATTENZIONE!
	<p>Rischio di caduta di componenti a causa di viti allentate! Danni a altre parti dell'apparecchio o all'abitazione del cliente, ad es. parte inferiore.</p> <ul style="list-style-type: none"> ▶ Fissare i componenti in modo che non cadano.

Prerequisiti:

- ✔ L'apparecchio è scollegato dalla rete elettrica.
- ✔ Gli accessori interni dell'apparecchio sono stati rimossi.
- ✔ La cerniera superiore è rimossa.

✔ La cerniera centrale è rimossa.

4.6.1 Smontaggio della cerniera inferiore della porta

- ▶ 1. Togliere la porta del comparto freezer (1).
- ▶ 2. Svitare la vite (2).
- ▶ 3. Ruotare la cerniera inferiore verso l'esterno (3).
- ▶ 4. Togliere la cerniera inferiore (4).

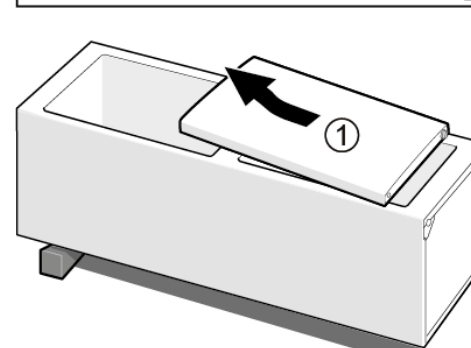
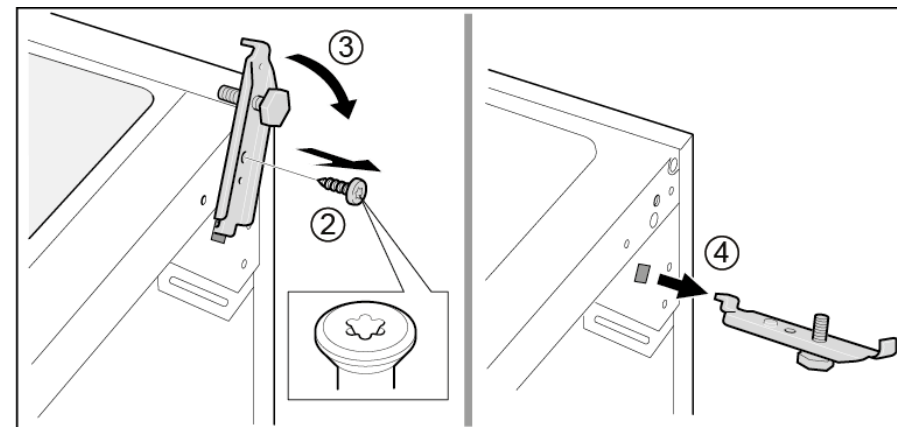

➡ La cerniera inferiore della porta è rimossa.

4.6.2 Montaggio della cerniera inferiore della porta

- ▶ Per il montaggio, seguire la procedura sopra descritta in senso opposto.

4.7 Sostituzione del ripiano

Prerequisiti:

- ✔ La porta è aperta.

4.7.1 Smontaggio del ripiano

- ▶ Estrarre il ripiano.

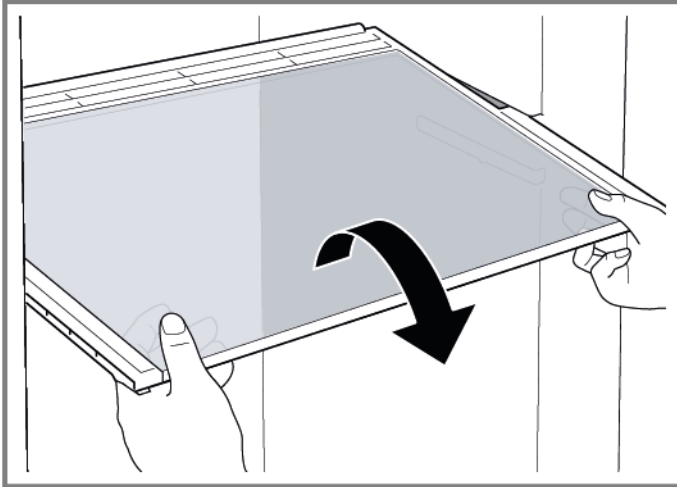

- ➡ Il ripiano è rimosso.

4.7.2 Montaggio del ripiano

- ▶ Per il montaggio, seguire la procedura sopra descritta in senso opposto.

4.8 Sostituzione del portabottiglie

Prerequisiti:

- ✔ La porta è aperta.

4.8.1 Smontaggio del portabottiglie

- ▶ Estrarre il portabottiglie.

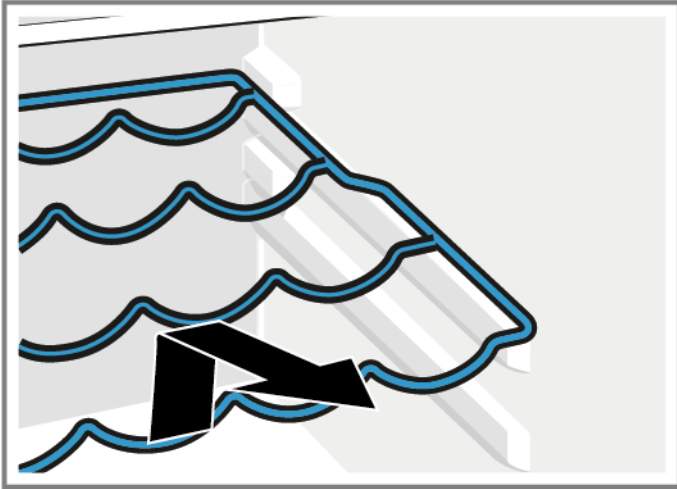

- ➡ Il portabottiglie è rimosso.

4.8.2 Montaggio del portabottiglie

- ▶ Per il montaggio, seguire la procedura sopra descritta in senso opposto.

4.9 Sostituzione del balconcino della porta

Prerequisiti:

- ✔ La porta è aperta.

4.9.1 Smontaggio del balconcino della porta

- ▶ Tirare il balconcino della porta verso l'alto.

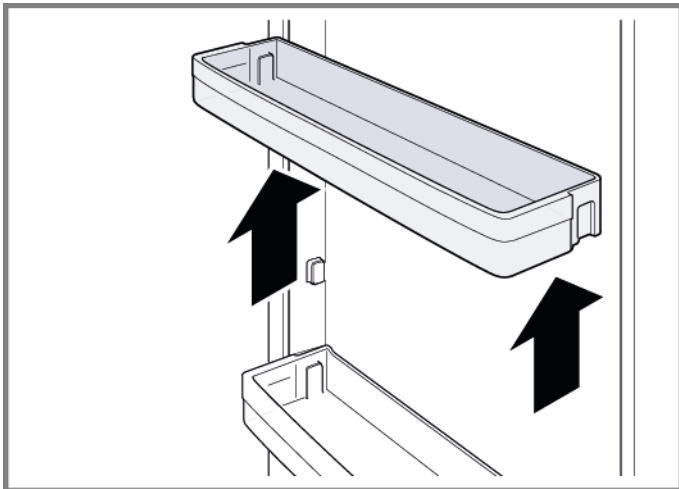

➡ Il balconcino della porta è rimosso.

4.9.2 Montaggio del balconcino della porta

- ▶ Per il montaggio, seguire la procedura sopra descritta in senso opposto.

4.10 Sostituzione del balconcino della porta regolabile

Prerequisiti:

- ✔ La porta è aperta.

4.10.1 Smontaggio del balconcino della porta regolabile

- ▶ Spostare il balconcino della porta regolabile verso l'alto finché il balconcino della porta non si sgancia dal supporto.

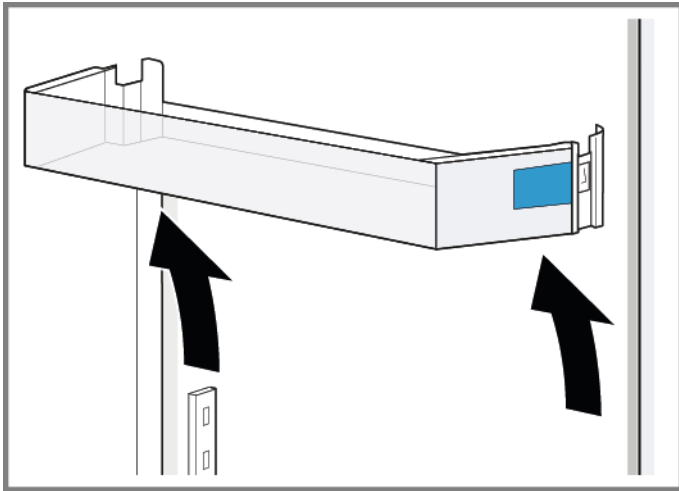

- ➡ Il balconcino della porta regolabile è rimosso.

4.10.2 Montaggio del balconcino della porta regolabile

- ▶ Per il montaggio, seguire la procedura sopra descritta in senso opposto.

4.11 Sostituzione del cassetto surgelati

Prerequisiti:

- ✔ La porta è aperta.

4.11.1 Rimozione del cassetto surgelati

- ▶ 1. Estrarre completamente il cassetto surgelati (1).
- ▶ 2. Togliere il cassetto surgelati (2).

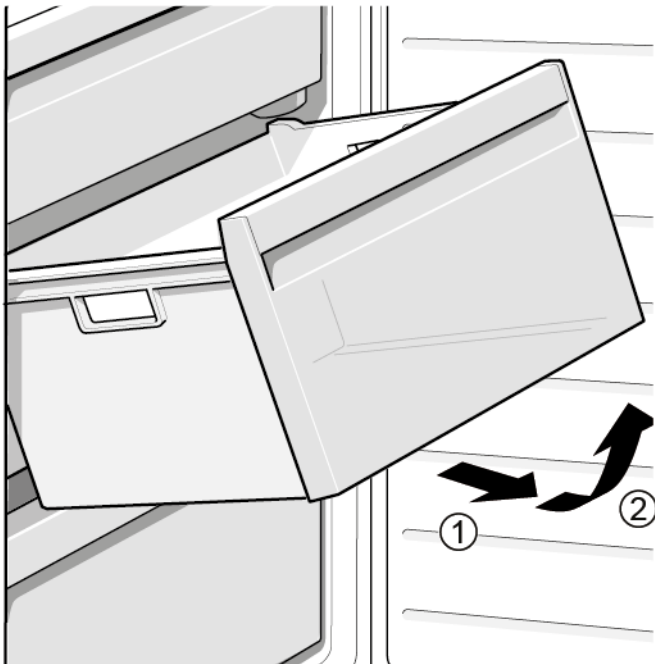

- ➡ Il cassetto surgelati è rimosso.

4.11.2 Inserimento del cassetto surgelati

- ▶ Per il montaggio, seguire la procedura sopra descritta in senso opposto.

4.12 Sostituzione del cassetto

Prerequisiti:

- ✔ La porta è aperta.

4.12.1 Estrazione del cassetto

- ▶ 1. Estrarre il cassetto inferiore (1).
- ▶ 2. Estrarre il cassetto superiore (2).

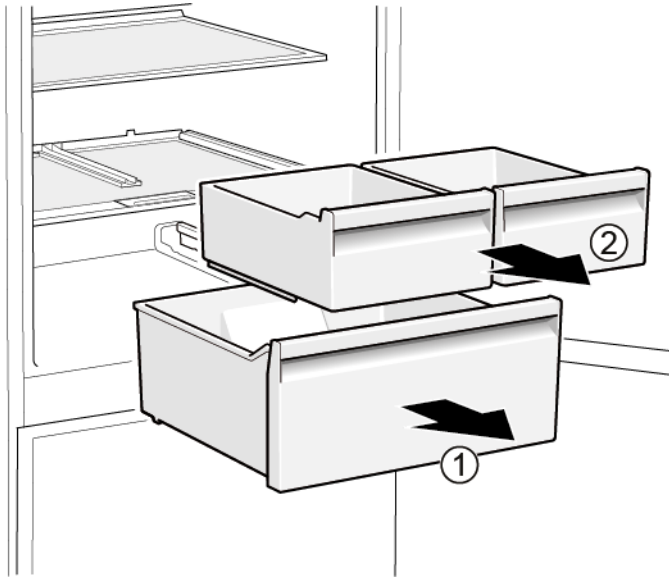

➡ I cassetti sono rimossi.

4.12.2 Inserimento del cassetto

- ▶ Per il montaggio, seguire la procedura sopra descritta in senso opposto.

4.13 Sostituzione del cassetto estraibile

Prerequisiti:

- ✔ La porta è aperta.

4.13.1 Rimozione del cassetto estraibile

- ▶ 1. Estrarre completamente il cassetto (1).
- ▶ 2. Togliere il cassetto estraibile (2).

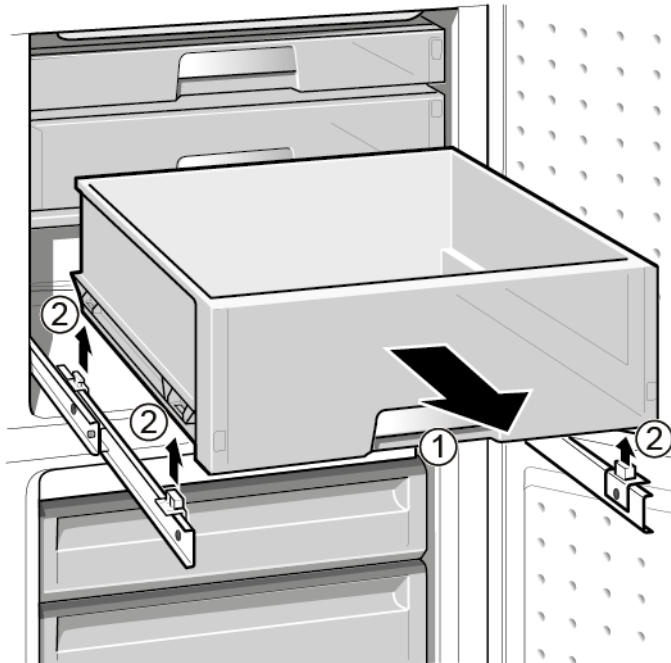

- ➡ Il cassetto estraibile è rimosso.

4.13.2 Inserimento del cassetto estraibile

- ▶ Per il montaggio, seguire la procedura sopra descritta in senso opposto.

4.14 Sostituzione del faretto a LED

Attrezzi speciali:

Utensile speciale [00342180]



L'apparecchio è dotato di una luce a LED esente da manutenzione. Queste luci possono essere riparate esclusivamente dall'assistenza clienti o da tecnici autorizzati!



PERICOLO

Rischio di scosse elettriche dovute a componenti sotto tensione!
Pericolo di morte dovuto a scosse elettriche in caso di riparazione non conforme

- ▶ Le parti elettriche devono essere riparate da elettricisti qualificati.
- ▶ Ultimata la riparazione, occorre eseguire un test di sicurezza conforme alla norma VDE 0701 o alle norme specifiche del Paese.



PERICOLO

Rischio di scossa elettrica dovuto a componenti sotto tensione!
Morte per folgorazione

- ▶ Scollegare l'apparecchio dall'alimentazione per almeno 60 secondi prima di iniziare la riparazione.



ATTENZIONE

Bordi taglienti!

- Ferite da taglio
- ▶ Indossare guanti di protezione.

Prerequisiti:

- ✓ L'apparecchio è scollegato dalla rete elettrica.
- ✓ La porta è aperta.

4.14.1 Smontaggio del faretto a LED

1. Utilizzare l'utensile speciale per estrarre il faretto a LED (1).

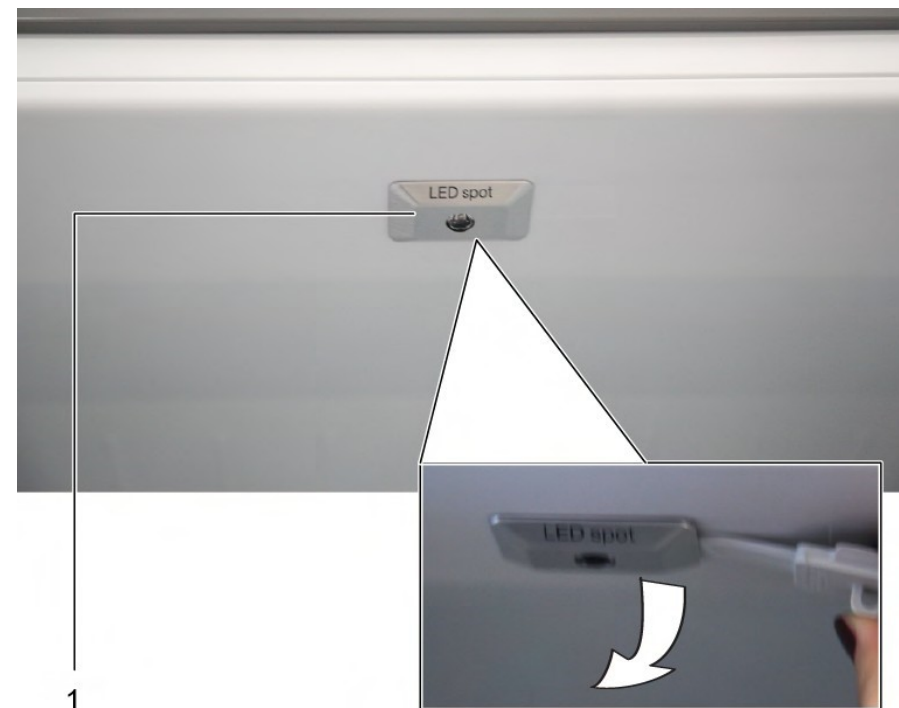

2. Rimuovere i collegamenti elettrici del faretto a LED.

➡ Il faretto a LED è rimosso.

4.14.2 Montaggio del faretto a LED

- ▶ Per il montaggio, seguire la procedura sopra descritta in senso opposto.

4.15 Sostituzione della luce a LED superiore

Attrezzi speciali:

-  Cacciavite a taglio Lama 2,4 mm x 0,4 mm x 60 mm, nel kit [00341820]

 L'apparecchio è dotato di una luce a LED esente da manutenzione. Queste luci possono essere riparate esclusivamente dall'assistenza tecnica o da tecnici autorizzati!

 **PERICOLO**
Rischio di scosse elettriche dovute a componenti sotto tensione!
Pericolo di morte dovuto a scosse elettriche in caso di riparazione non conforme

- ▶ Le parti elettriche devono essere riparate da elettricisti qualificati.
- ▶ Ultimata la riparazione, occorre eseguire un test di sicurezza conforme alla norma VDE 0701 o alle norme specifiche del Paese.



 **PERICOLO**
Rischio di scossa elettrica dovuto a componenti sotto tensione!
Morte per folgorazione

- ▶ Scollegare l'apparecchio dall'alimentazione per almeno 60 secondi prima di iniziare la riparazione.

 **ATTENZIONE**
Bordi taglienti!
Ferite da taglio

- ▶ Indossare guanti di protezione.

Prerequisiti:

-  L'apparecchio è scollegato dalla rete elettrica.
-  La porta è aperta.
-  Gli accessori interni superiori sono stati rimossi.

4.15.1 Smontaggio della luce a LED

1. Spostare la luce a LED sul lato sinistro.

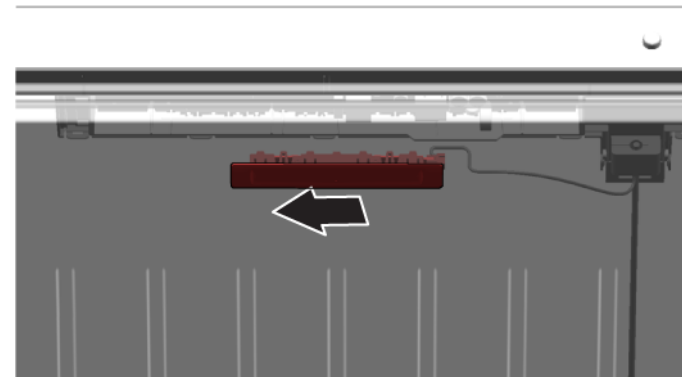

-  Il collegamento elettrico della luce a LED è scollegato.

2. Sbloccare i fermi della luce a LED.

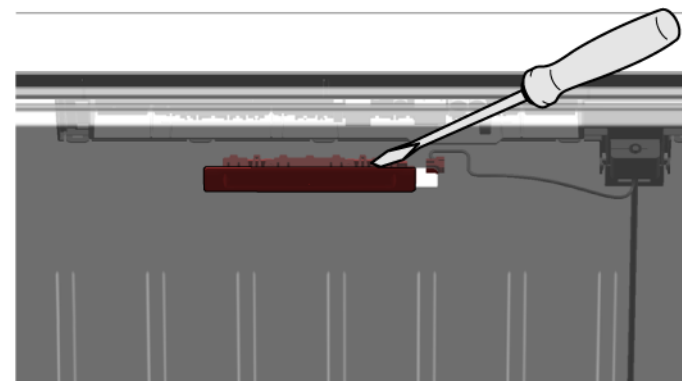

3. Togliere la luce a LED spostandola in avanti.

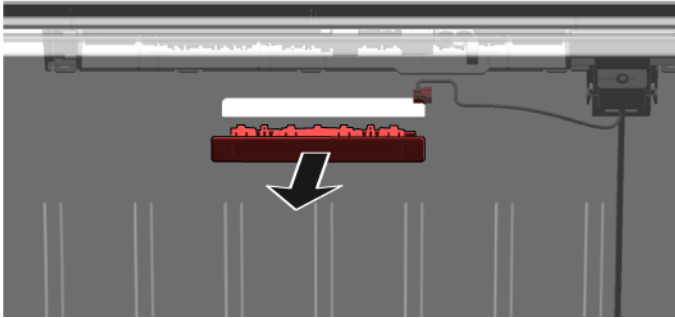

- ➡ La luce LED è rimossa.

4.15.2 Montaggio della luce a LED superiore

- ▶ Per il montaggio, seguire la procedura sopra descritta in senso opposto.

4.16 Sostituzione della luce a barra laterale a LED

Attrezzi speciali:

Ventosa Ø50 mm [00342224]



L'apparecchio è dotato di una luce a LED esente da manutenzione. Queste luci possono essere riparate esclusivamente dall'assistenza clienti o da tecnici autorizzati!



PERICOLO

Rischio di scosse elettriche dovute a componenti sotto tensione!
Pericolo di morte dovuto a scosse elettriche in caso di riparazione non conforme

- ▶ Le parti elettriche devono essere riparate da elettricisti qualificati.
- ▶ Ultimata la riparazione, occorre eseguire un test di sicurezza conforme alla norma VDE 0701 o alle norme specifiche del Paese.



PERICOLO

Rischio di scossa elettrica dovuto a componenti sotto tensione!
Morte per folgorazione

- ▶ Scollegare l'apparecchio dall'alimentazione per almeno 60 secondi prima di iniziare la riparazione.



ATTENZIONE

Bordi taglienti!

Ferite da taglio
▶ Indossare guanti di protezione.

Prerequisiti:

- ✓ L'apparecchio è scollegato dalla rete elettrica.
- ✓ La porta è aperta.
- ✓ I ripiani del comparto frigorifero sono rimossi.

4.16.1 Smontaggio della luce a barra laterale a LED

1. Fissare la ventosa sul terzo superiore della luce a barra laterale a LED.



Riparazione

2. Tirare la ventosa in avanti con la luce a barra laterale a LED con un unico movimento rotatorio.

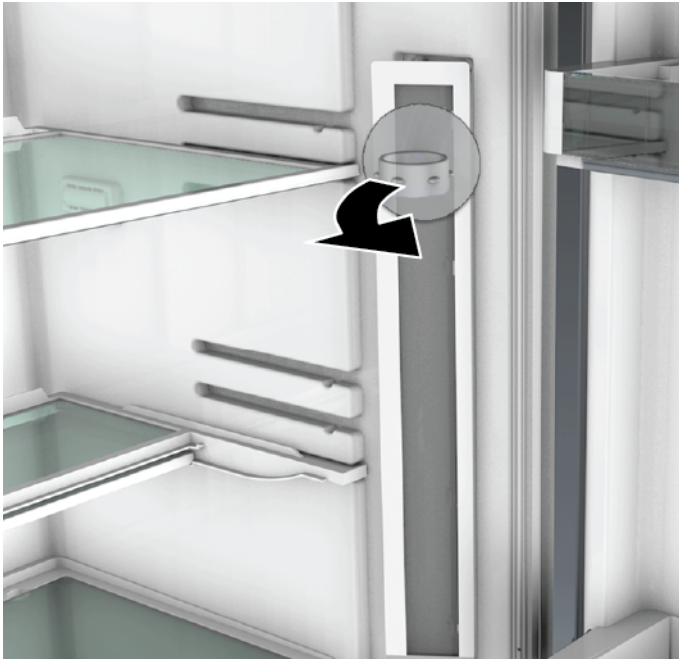



3. Staccare il collegamento della luce a barra laterale a LED.
➡ La luce a barra laterale a LED è rimossa.

4.16.2 Montaggio della luce a barra laterale a LED

1. Collegare il collegamento elettrico della luce a barra laterale a LED.
 2. Fissare la luce a barra laterale a LED in posizione sulla parete del comparto (i fermi si agganciano).
- ➡ La luce a barra laterale a LED è montata.

4.17 Sostituzione del faretto a LED

Attrezzi speciali:

-  Utensile speciale [00342180]
-  Cacciavite a taglio Lama 2,4 mm x 0,4 mm x 60 mm, nel kit [00341820]

 L'apparecchio è dotato di una luce a LED esente da manutenzione. Queste luci possono essere riparate esclusivamente dall'assistenza clienti o da tecnici autorizzati!

 **PERICOLO**
Rischio di scosse elettriche dovute a componenti sotto tensione!
Pericolo di morte dovuto a scosse elettriche in caso di riparazione non conforme

- ▶ Le parti elettriche devono essere riparate da elettricisti qualificati.
- ▶ Ultimata la riparazione, occorre eseguire un test di sicurezza conforme alla norma VDE 0701 o alle norme specifiche del Paese.



 **PERICOLO**
Rischio di scossa elettrica dovuto a componenti sotto tensione!
Morte per folgorazione

- ▶ Scollegare l'apparecchio dall'alimentazione per almeno 60 secondi prima di iniziare la riparazione.

 **ATTENZIONE**
Bordi taglienti!
Ferite da taglio

- ▶ Indossare guanti di protezione.

Prerequisiti:

-  L'apparecchio è scollegato dalla rete elettrica.
-  La porta è aperta.
-  I ripiani del comparto frigorifero sono rimossi.

4.17.1 Smontaggio del faretto a LED

1. Sganciare il coperchio del faretto a LED.

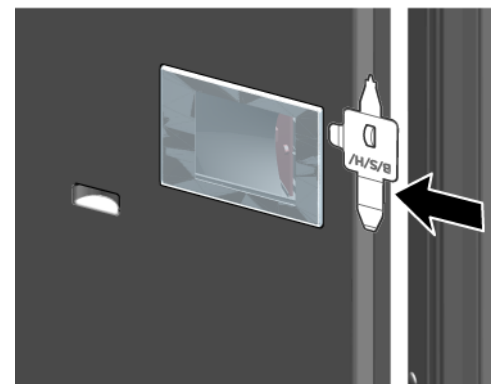

2. Tirare il coperchio del faretto a LED all'interno e contemporaneamente spingerlo in avanti.

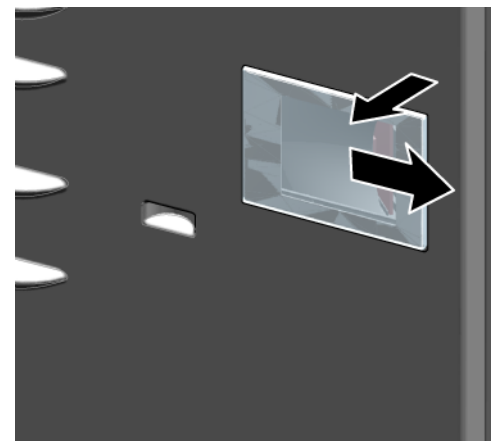

3. Staccare il modulo del faretto a LED.

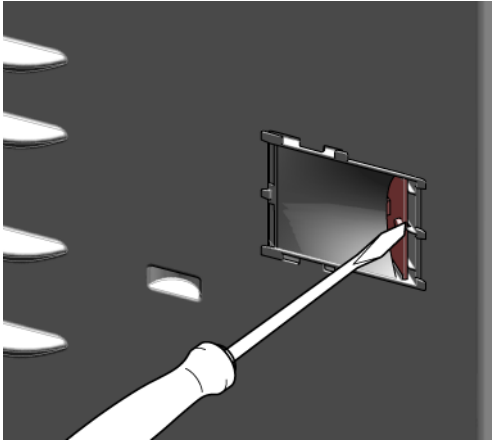

4. Staccare il collegamento elettrico del faretto a LED.

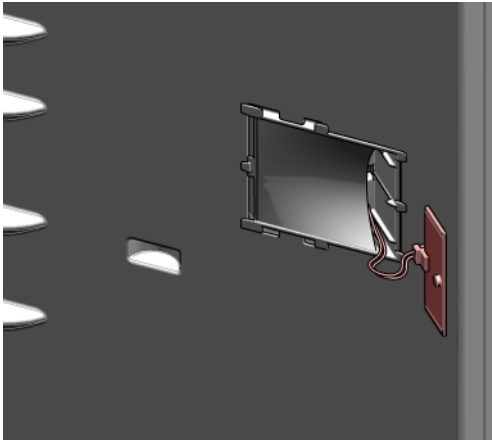

- ➡ Il faretto a LED è rimosso.

4.17.2 Montaggio del faretto a LED

- ▶ Per il montaggio, seguire la procedura sopra descritta in senso opposto.

Informācija par remontu - Dzesēšanas un saldēšanas kombinācija

 Par šo dokumentu	380
1.1 Būtiska informācija	380
1.1.1 Mērķis	380
1.2 Simbolu skaidrojums.....	380
1.2.1 Bīstamības līmeņi	380
1.2.2 Bīstamības simboli	380
1.2.3 Brīdinājumu struktūra	381
1.2.4 Vispārīgie simboli.....	381
 Drošība	382
2.1 Vispārējie drošības norādījumi	382
2.1.1 Visām mājsaimniecības ierīcēm	382
 Piederumi un palīgļīdzekļi	383
 Remonts	384
4.1 Durvju blīvslēga nomaiņa	384
4.1.1 Durvju blīvslēga noņemšana	384
4.1.2 Durvju blīvslēga uzstādīšana	384
4.2 Durvju roktura nomaiņa.....	387
4.2.1 Durvju roktura noņemšana.....	387
4.2.2 Durvju roktura uzstādīšana	387
4.3 Durvju augšējās viras nomaiņa.....	388
4.3.1 Durvju augšējās viras noņemšana.....	388
4.3.2 Durvju augšējās viras uzstādīšana	389
4.4 Durvju augšējās viras nomaiņa (durvis ar displeju)	390
4.4.1 Durvju augšējās viras noņemšana.....	390
4.4.2 Durvju augšējās viras uzstādīšana	391
4.5 Durvju vidējās viras nomaiņa	392
4.5.1 Durvju vidējās viras noņemšana.....	392
4.5.2 Durvju vidējās viras uzstādīšana	392
4.6 Durvju apakšējās viras nomaiņa	393
4.6.1 Durvju apakšējās viras noņemšana.....	393
4.6.2 Durvju apakšējās viras uzstādīšana	393
4.7 Plaukta nomaiņa.....	394
4.7.1 Plaukta izņemšana	394
4.7.2 Plaukta uzstādīšana	394

4.8 Pudeļu plaukta nomaiņa	395
4.8.1 Pudeļu plaukta izņemšana	395
4.8.2 Pudeļu plaukta uzstādīšana	395
4.9 Durvju plaukta nomaiņa.....	396
4.9.1 Durvju plaukta noņemšana.....	396
4.9.2 Durvju plaukta uzstādīšana	396
4.10 Regulējamā durvju plaukta nomaiņa.....	397
4.10.1 Regulējamā durvju plaukta noņemšana	397
4.10.2 Regulējamā durvju plaukta uzstādīšana	397
4.11 Saldētās pārtikas tvertnes nomaiņa.....	398
4.11.1 Saldētās pārtikas tvertnes izņemšana	398
4.11.2 Saldētās pārtikas tvertnes uzstādīšana	398
4.12 Tvertnes nomaiņa	399
4.12.1 Tvertnes izņemšana	399
4.12.2 Tvertnes uzstādīšana	399
4.13 Izvelkamās tvertnes nomaiņa.....	400
4.13.1 Izvelkamās tvertnes izņemšana	400
4.13.2 Izvelkamās tvertnes uzstādīšana	400
4.14 LED starmeša nomaiņa	401
4.14.1 LED starmeša noņemšana	401
4.14.2 LED starmeša uzstādīšana	401
4.15 Augšējā LED gaismekļa nomaiņa.....	402
4.15.1 LED gaismekļa noņemšana.....	402
4.15.2 Augšējā LED gaismekļa uzstādīšana	403
4.16 Sānu LED apgaismes joslas nomaiņa	404
4.16.1 Sānu LED apgaismes joslas noņemšana	404
4.16.2 Sānu LED apgaismes joslas uzstādīšana.....	405
4.17 LED starmeša nomaiņa	406
4.17.1 LED starmeša noņemšana	406
4.17.2 LED starmeša uzstādīšana	407

i Par šo dokumentu

1.1 Būtiska informācija

1.1.1 Mērķis

Šie labošanas ieteikumi ir paredzēti patērētājam, patstāvīgi labojot ierīces, saskaņā ar piemērojamo Ekodizaina regulu (sākot no 03.2021.).





Tajā ir sniegta informācija par to, kā nomainīt noteiktas rezerves daļas, kā arī brīdinājumi un riski.

Jautājumu gadījumā lūdzam sazināties ar mūsu klientu apkalpošanas dienestu. Mēs esam atbildīgi par zaudējumiem tikai tad, ja ir pienācīgi ievēroti šie labošanas ieteikumi.

1.2 Simbolu skaidrojums

1.2.1 Bīstamības līmeņi

Brīdinājuma līmeņus veido simbols un signālvārds. Signālvārds apzīmē bīstamības pakāpi.





Brīdinājuma līmenis	Nozīme
 BĪSTAMI	Brīdinājuma paziņojuma neievērošanas rezultātā iestāsies nāve vai radīsies smagas traumas.
 BRĪDINĀJUMS	Brīdinājuma paziņojuma neievērošanas rezultātā var iestāties nāve vai rasties smagas traumas.
 ESJET PIESARDŽĪGI	Brīdinājuma paziņojuma neievērošanas rezultātā var rasties nelielas traumas.
 UZMANĪBU!	Brīdinājuma paziņojuma neievērošanas rezultātā var rasties kaitējums īpašumam.

Tabula 1: Bīstamības līmeņi



1.2.2 Bīstamības simboli

Bīstamības simboli ir simboliski apzīmējumi, kas sniedz norādes par bīstamības veidu.

Šajā dokumentā ir izmantoti šādi bīstamības simboli:

Bīstamības simbols	Nozīme
	Vispārējs brīdinājuma paziņojums
	Elektriskā sprieguma radīts apdraudējums
	Sprādzienbīstamības risks
	Griezumu bīstamība
	Saspiešanas bīstamība

i Par šo dokumentu

Bīstamības simbols	Nozīme
	Karstu virsmu radīta bīstamība
	Spēcīgu magnētisko lauku radīta bīstamība
	Nejonizējoša starojuma radīta bīstamība

Tabula 2: Bīstamības simboli

1.2.3 Brīdinājumu struktūra

Šajā dokumentā sniegtajiem brīdinājumiem ir standartizēts noformējums un standartizēta struktūra.



	<p>⚠ BĪSTAMI</p> <p>Bīstamības veids un avots! Iespējamās sekas, kas rodas, neievērojot bīstamības paziņojumu / brīdinājumu.</p> <ul style="list-style-type: none"> ▶ Bīstamības novēršanas pasākumi un aizliegumi.
--	--





Nākamajā piemērā ir parādīts brīdinājums, kas apzīmē elektrotrieciena risku, ko rada spriegumaktīvas detaļas. Ir norādīts bīstamības novēršanas pasākums.

	<p>⚠ BĪSTAMI</p> <p>Elektrotrieciena risks, ko rada spriegumaktīvas detaļas! Nāvējošs elektrotrieciens</p> <ul style="list-style-type: none"> ▶ Atvienojiet iekārtas no strāvas padeves vismaz 60 sekundes pirms labošanas sākšanas.
--	---

1.2.4 Vispārīgie simboli

Šajā dokumentā ir izmantoti šādi vispārīgie simboli:

Visp. simbols	Nozīme
	Īpašu ieteikumu apzīmējums (teksts un/ vai grafika)
	Vienkāršu ieteikumu apzīmējums (tikai teksts)

Visp. simbols	Nozīme
	Video pamācības saites apzīmējums
	Nepieciešamo rīku apzīmējums
	Nepieciešamo priekšnosacījumu apzīmējums
	Nosacījuma apzīmējums (ja ..., tad ...)
	Rezultāta apzīmējums
[Sākt]	Taustiņa vai pogas apzīmējums
[00123456]	Materiāla numura apzīmējums
Statuss	Attēlotā teksta / loga apzīmējums (iekārtas displejā)

Tabula 3: Vispārīgie simboli

2.1 Vispārējie drošības norādījumi

2.1.1 Visām mājsaimniecības ierīcēm

Elektrotrieciena risks spriegumaktīvu daļu dēļ!

- Ja remonts, kas skar elektriskās daļas, ir veikts kļūdaini, pastāv elektrotrieciena risks!
- Ierīcei ir jābūt atvienotai no tīkla vismaz 60 sekundes, pirms sāk darbu.
- Pēc remonta ierīces drošība ir jāpārbauda atbilstīgi noteikumiem VDE 0701 vai valsts noteikumiem.

Savainojumu risks asu malu dēļ!

- Valkājiet aizsargcimdus.

Saspiešanas risks labošanas, uzturēšanas, traucējumu novēršanas un apkopes laikā, ko rada smagas un kustīgas detaļas

- Valkājiet aizsargapavus.
- Nostipriniet smagas detaļas, lai tās nenokristu.
- Neievietojiet ķermeņa daļas kustīgās detaļās.





Ierīces drošības / darbības traucējuma risks!

- Izmantojiet tikai oriģinālās rezerves daļas.

Pret elektrostatisko izlādi jutīgu daļu (ESDS) bojājuma risks!

- Neaiztieciet moduļus, ieskaitot savienojumus un vadojumu.

Piederumi un palīglīdzekļi

Apzīmējums	Sīkāka informācija	Attēli
Aizsargdrāna [00342013]	60 cm x 50 cm	
Plakanais skrūvgriezis	Izmērs: 2,4 mm x 0,4 mm x 60 mm, komplektā [00341820]	
Īpašs darbarīks [00342180]		
Piesūceknis [00342224]	Ø50 mm	
Torx uzgalis TX20 [00340865]	6,3 mm (1/4")	
Plakanais skrūvgriezis	Izmērs: 10 mm x 1,6 mm x 200 mm	

4.1 Durvju blīvslēga nomaīņa

Prasība:

- ✓ Durvīm ir jābūt atvērtām.

4.1.1 Durvju blīvslēga noņemšana

1. Atbrīvojiet durvju blīvslēgu no rievas labajā un kreisajā pusē.

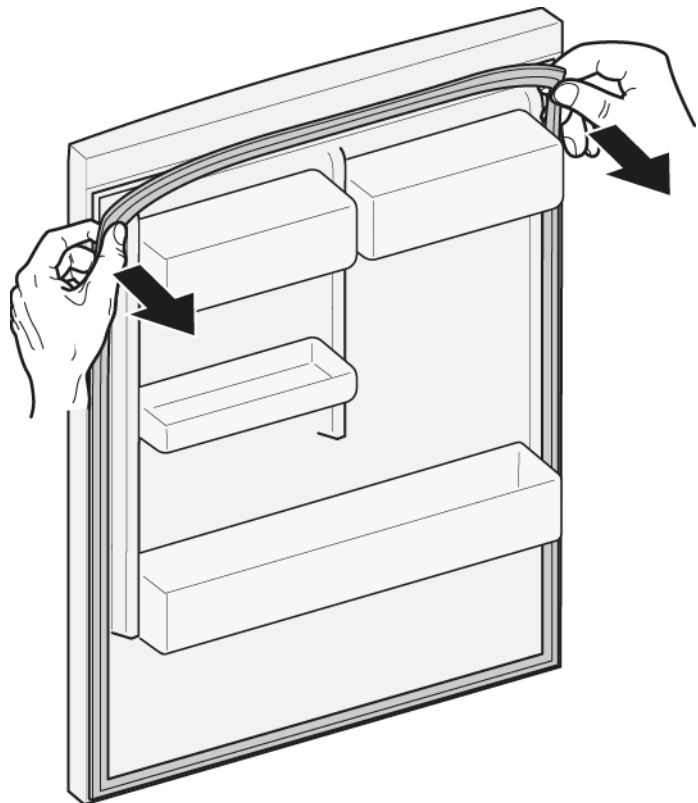

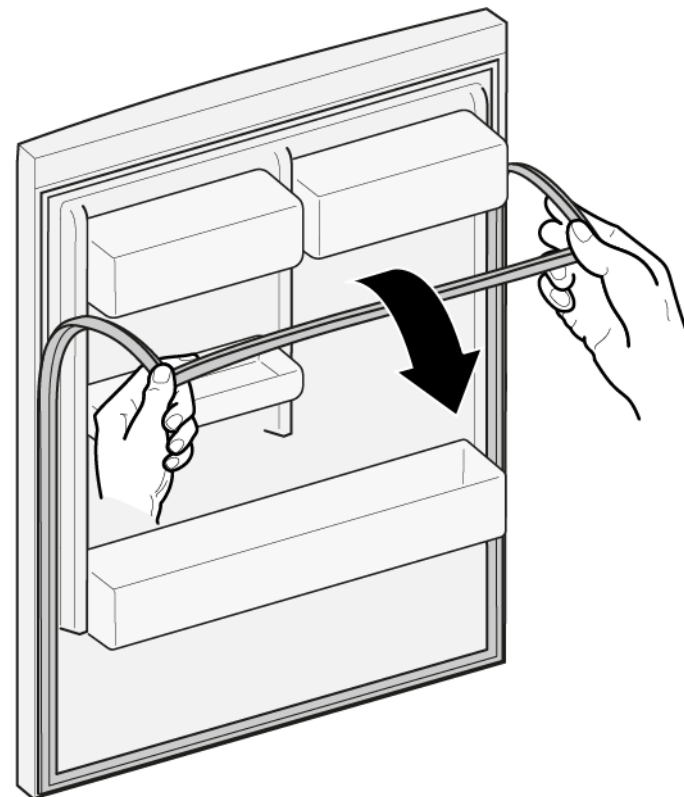

2. Izvelciet durvju blīvslēgu no rievas.





- ➡ Durvju blīvslēgs ir noņemts.

4.1.2 Durvju blīvslēga uzstādīšana

	Jaunā durvju blīvslēga biezums var mazliet atšķirties no vecā durvju blīvslēga biezuma. Tas neietekmē aizvēršanos un darbību ilgtermiņā.
	Ja ierīces viras var regulēt vai tai ir viru savienojumi, vēlāk aizvēršanos var pielāgot.
	Mazie caurumi durvju blīvslēga sānos ir funkcionāli (nodrošina ventilāciju). Tie nav ražošanas defekti.

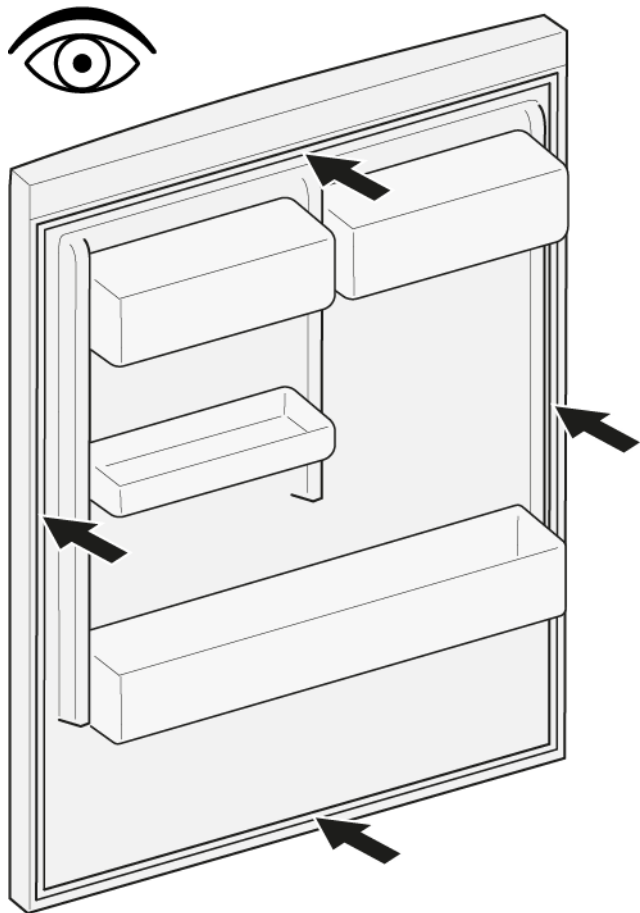
1. Pārbaudiet, ka blīvslēga rieta nav bojāta.



2.  Ja blīvslēga rieta ir bojāta
- Sazinieties ar klientu apkalpošanas dienesta pārstāvi.

3.  Durvju blīvslēgs var būt mazliet deformējies, kas neietekmē tā darbību. Pirms durvju blīvslēgu ieliek ierīcē, to ir ieteicams iztaisnot.

Sasildiet durvju blīvslēgu ar matu fēnu vai karstā ūdenī un ar rokām atjaunojiet tā formu.

4. Iespiediet blīvslēga augšējos un apakšējos stūrus rieta.

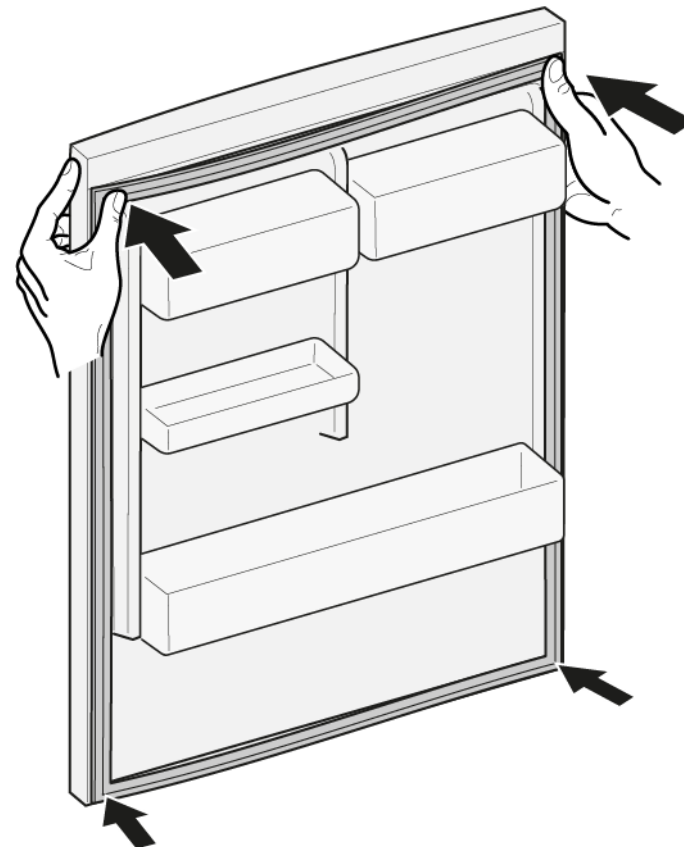

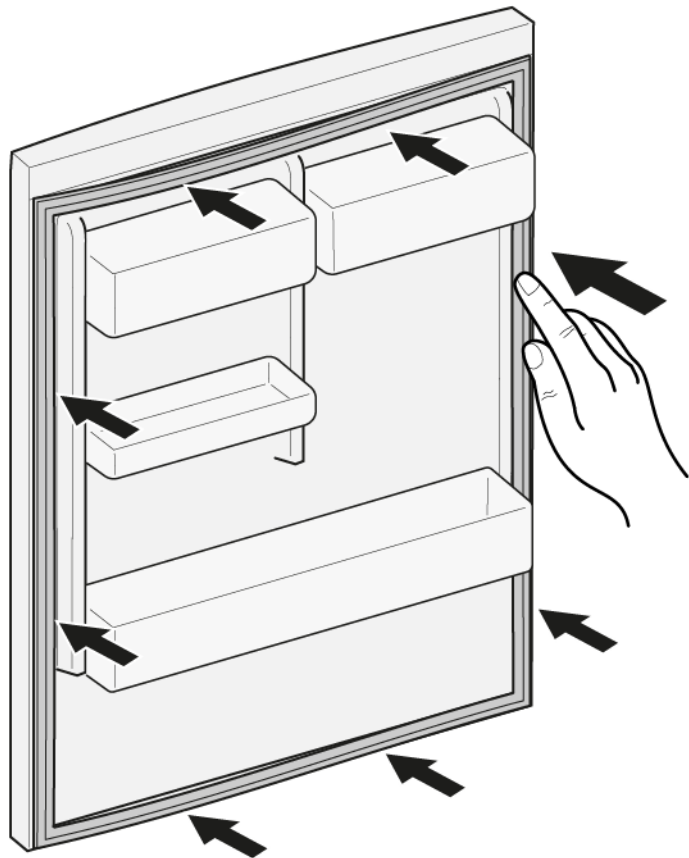

5. Pakāpeniski iespiediet visu blīvslēgu rievā.





 Durvju blīvslēgs ir uzstādīts.

4.2 Durvju roktura nomaiņa

Speciāli rīki:

-  Torx uzgalis TX20 6,3 mm (1/4") [00340865]
-  Plakanais skrūvgriezis Izmērs: 10 mm x 1,6 mm x 200 mm

Prasība:

-  Ierīces elektropadevei ir jābūt atvienotai.
-  Durvīm ir jābūt atvērtām.

4.2.1 Durvju roktura noņemšana

- ▶ 1. Noņemiet abu skrūvju vāciņus (1).
- ▶ 2. Izskrūvējiet abas skrūves (2).
- ▶ 3. Noņemiet durvju rokturi (3).

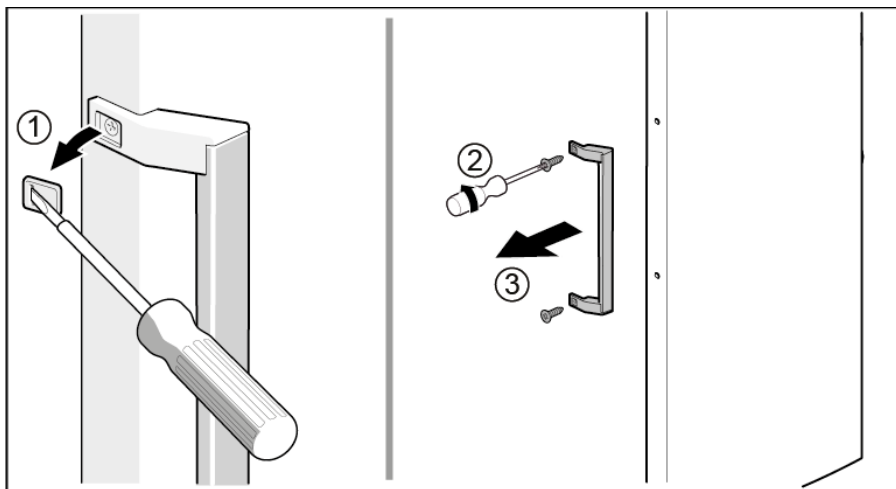

 Durvju rokturis ir noņemts.



Otru durvju rokturi noņem tāpat.

4.2.2 Durvju roktura uzstādīšana

- ▶ Uzstādiet apgrieztā kārtībā.

4.3 Durvju augšējās viras nomaiņa

Speciāli rīki:

Torx uzgalis TX20

6,3 mm (1/4")

[00340865]

	<p style="text-align: center;">BRĪDINĀJUMS</p> <p>Smaga lielizmēra ierīce! Muguras un muskuļu savainojumi</p> <ul style="list-style-type: none"> ▶ Ierīces durvis drīkst noņemt tikai apmācīts speciālists. ▶ Ierīce ir jāpārvieta divatā. ▶ Ir jāizmanto tikai piemēroti darbarīki un aprīkojums.
	<p style="text-align: center;">ESIET PIESARDZĪGI</p> <p>Asas malas! Grieztas brūces</p> <ul style="list-style-type: none"> ▶ Lietojiet aizsargcimdus.
	<p style="text-align: center;">BRĪDINĀJUMS</p> <p>Sasvērušos ierīču paslīdēšana! Kaulu lūzumi / saspiešanas traumas</p> <ul style="list-style-type: none"> ▶ Nostipriniet ierīces, lai tās neslīdētu.
	<p style="text-align: center;">ESIET PIESARDZĪGI</p> <p>Krītošu detaļu risks, ko izraisa vaļīgās skrūves! Krītošu detaļu izraisītas traumas.</p> <ul style="list-style-type: none"> ▶ Nostipriniet detaļu, lai tā nenokristu.
	<p style="text-align: center;">UZMANĪBU!</p> <p>Krītošu detaļu risks, ko izraisa vaļīgās skrūves! Citu ierīces detaļu bojājumi vai bojājumi, kas rodas klienta mājās, piem., apakšpuse.</p> <ul style="list-style-type: none"> ▶ Nostipriniet detaļu, lai tā nenokristu.

Prasība:

- ✓ Ierīces elektropadevei ir jābūt atvienotai.
- ✓ Ierīces iekšējām daļām ir jābūt izņemtām.

4.3.1 Durvju augšējās viras noņemšana

1. Nolieciet ierīci uz aizmugures.

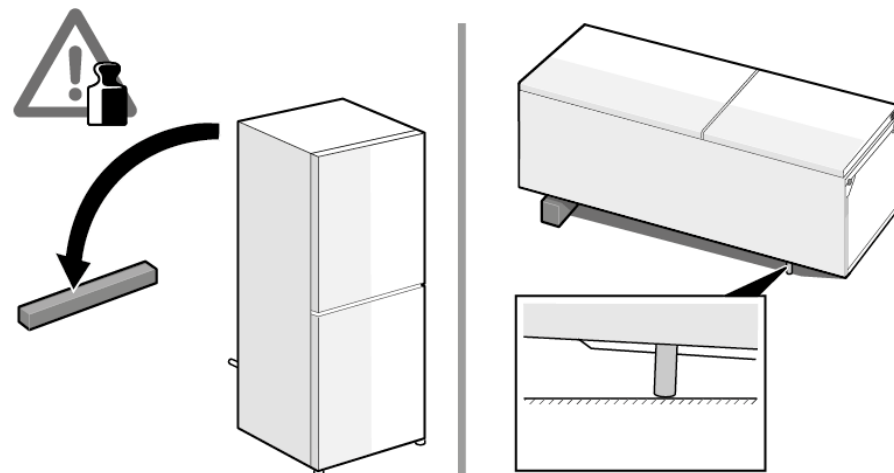

2. 1. Saspiediet augšējās viras pārsega abus sānus (1).
2. Pavelciet augšējās viras pārsegu (2).
3. Pagrieziet viras pārsegu (3).
4. Noņemiet augšējās viras pārsegu (4).
5. Izskrūvējiet abas skrūves (5).
6. Noņemiet augšējo viru (6).

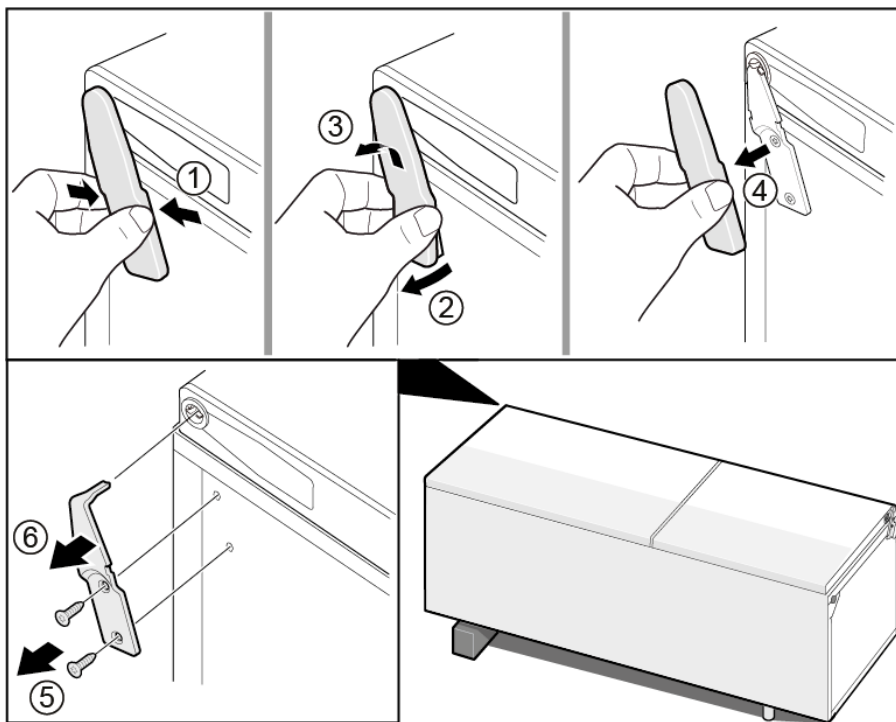

 Augšējā vira ir noņemta.

4.3.2 Durvju augšējās viras uzstādīšana

- ▶ Uzstādiet apgrieztā kārtībā.

4.4 Durvju augšējās viras nomaiņa (durvis ar displeju)

Speciāli rīki:

Torx uzgalis TX20 6,3 mm (1/4") [00340865]

	BRĪDINĀJUMS
	<p>Smaga lielizmēra ierīce! Muguras un muskuļu savainojumi</p> <ul style="list-style-type: none"> ▶ Ierīces durvis drīkst noņemt tikai apmācīts speciālists. ▶ Ierīce ir jāpārvieta divatā. ▶ Ir jāizmanto tikai piemēroti darbarīki un aprīkojums.

	ESIET PIESARDZĪGI
	<p>Asas malas! Grieztas brūces</p> <ul style="list-style-type: none"> ▶ Lietojiet aizsargcimdus.

	BRĪDINĀJUMS
	<p>Sasvērušos ierīču paslīdēšana! Kaulu lūzumi / saspiešanas traumas</p> <ul style="list-style-type: none"> ▶ Nostipriniet ierīces, lai tās neslīdētu.

	ESIET PIESARDZĪGI
	<p>Krītošu detaļu risks, ko izraisa vaļīgās skrūves! Krītošu detaļu izraisītas traumas.</p> <ul style="list-style-type: none"> ▶ Nostipriniet detaļu, lai tā nenokristu.

	UZMANĪBU!
	<p>Krītošu detaļu risks, ko izraisa vaļīgās skrūves! Citu ierīces detaļu bojājumi vai bojājumi, kas rodas klienta mājās, piem., apakšpuse.</p> <ul style="list-style-type: none"> ▶ Nostipriniet detaļu, lai tā nenokristu.

	BĪSTAMI
	<p>Elektrotrieciena risks spriegumaktīvu daļu dēļ! Dzīvības apdraudējums nepareiza remonta izraisīta elektrotrieciena dēļ</p> <ul style="list-style-type: none"> ▶ Elektriskās daļas ir jāremontē kvalificētam elektriķim. ▶ Pēc remonta ierīces drošība ir jāpārbauda atbilstīgi noteikumiem VDE 0701 vai valsts noteikumiem.

	BĪSTAMI
	<p>Elektrotrieciena risks, ko rada spriegumaktīvas detaļas! Nāvējošs elektrotrieciens</p> <ul style="list-style-type: none"> ▶ Atvienojiet iekārtas no strāvas padeves vismaz 60 sekundes pirms labošanas sākšanas.

Prasība:

- Ierīces elektropadevei ir jābūt atvienotai.
- Ierīces iekšējām daļām ir jābūt izņemtām.

4.4.1 Durvju augšējās viras noņemšana

1. Nolieciet ierīci uz aizmugures.

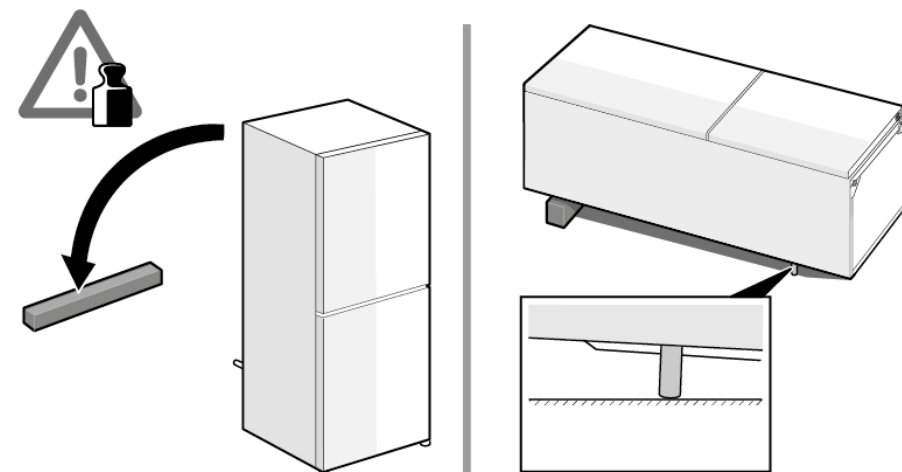

2. 1. Noņemiet augšējās viras pārsegu (1).
2. Noņemiet kabeļa kārbas vāku (2).
3. Atvienojiet elektriskos savienojumus (3).
4. Izskrūvējiet zemētājsavienojuma skrūvi (4).
5. Noņemiet kabeļa aizsargu (5).
6. Izskrūvējiet skrūvi (6).

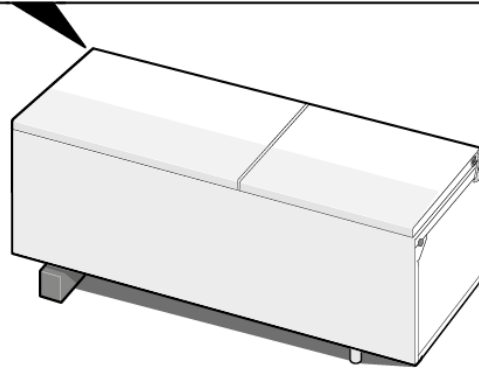
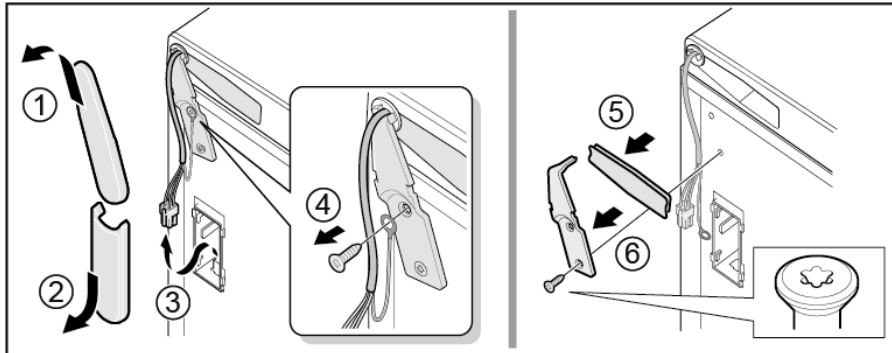

 Augšējā vira ir noņemta.

4.4.2 Durvju augšējās viras uzstādīšana

- ▶ Uzstādiet apgrieztā kārtībā.

4.5 Durvju vidējās viras nomaiņa

Speciāli rīki:

Torx uzgalis TX20 6,3 mm (1/4") [00340865]

	<p>BRĪDINĀJUMS</p> <p>Smaga lielizmēra ierīce! Muguras un muskuļu savainojumi</p> <ul style="list-style-type: none"> ▶ Ierīces durvis drīkst noņemt tikai apmācīts speciālists. ▶ Ierīce ir jāpārvieta divatā. ▶ Ir jāizmanto tikai piemēroti darbarīki un aprīkojums.
	<p>ESIET PIESARDZĪGI</p> <p>Asas malas! Grieztas brūces</p> <ul style="list-style-type: none"> ▶ Lietojiet aizsargcimdus.
	<p>BRĪDINĀJUMS</p> <p>Sasvērušos ierīču paslīdēšana! Kaulu lūzumi / saspiešanas traumas</p> <ul style="list-style-type: none"> ▶ Nostipriniet ierīces, lai tās neslīdētu.
	<p>ESIET PIESARDZĪGI</p> <p>Krītošu detaļu risks, ko izraisa vaļīgās skrūves! Krītošu detaļu izraisītas traumas.</p> <ul style="list-style-type: none"> ▶ Nostipriniet detaļu, lai tā nenokristu.
	<p>UZMANĪBU!</p> <p>Krītošu detaļu risks, ko izraisa vaļīgās skrūves! Citu ierīces detaļu bojājumi vai bojājumi, kas rodas klienta mājās, piem., apakšpuse.</p> <ul style="list-style-type: none"> ▶ Nostipriniet detaļu, lai tā nenokristu.

Prasība:

- ✓ Ierīces elektropadevei ir jābūt atvienotai.
- ✓ Ierīces iekšējām daļām ir jābūt izņemtām.
- ✓ Durvju augšējā vira ir noņemta.

4.5.1 Durvju vidējās viras noņemšana

- ▶ 1. Noņemiet ledusskapja nodalījuma durvis (1).
- ▶ 2. Izskrūvējiet abas skrūves (2).
- ▶ 3. Noņemiet vidējo viru (3).

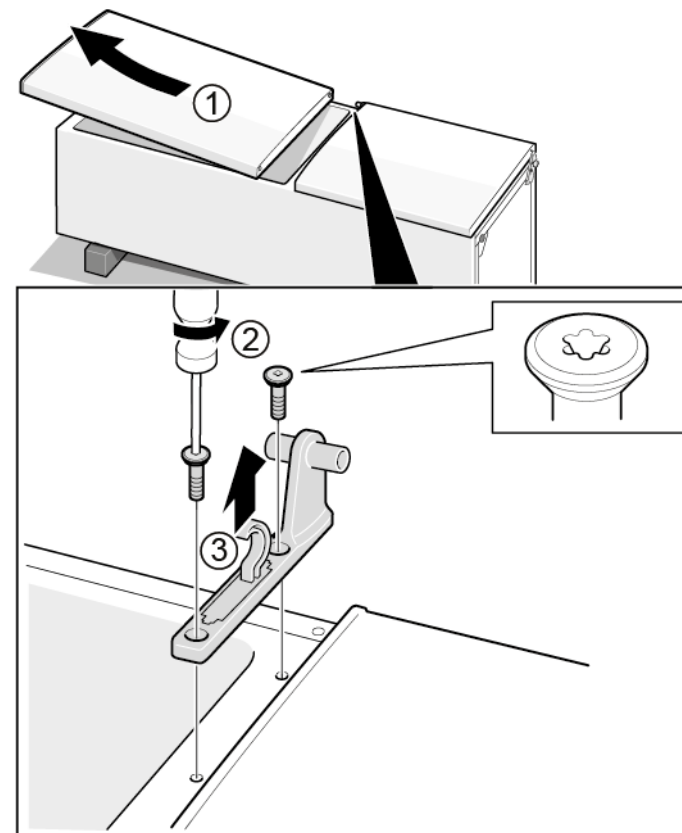

➡ Vidējā vira ir noņemta.

4.5.2 Durvju vidējās viras uzstādīšana

- ▶ Uzstādiet apgrieztā kārtībā.

4.6 Durvju apakšējās viras nomaiņa

Speciāli rīki:

Torx uzgalis TX20 6,3 mm (1/4") [00340865]

	<p>BRĪDINĀJUMS</p> <p>Smaga lielizmēra ierīce! Muguras un muskuļu savainojumi</p> <ul style="list-style-type: none"> ▶ Ierīces durvis drīkst noņemt tikai apmācīts speciālists. ▶ Ierīce ir jāpārvieta divatā. ▶ Ir jāizmanto tikai piemēroti darbarīki un aprīkojums.
	<p>ESIET PIESARDZĪGI</p> <p>Asas malas! Grieztas brūces</p> <ul style="list-style-type: none"> ▶ Lietojiet aizsargcimdus.
	<p>BRĪDINĀJUMS</p> <p>Sasvērušos ierīču paslīdēšana! Kaulu lūzumi / saspiešanas traumas</p> <ul style="list-style-type: none"> ▶ Nostipriniet ierīces, lai tās neslīdētu.
	<p>ESIET PIESARDZĪGI</p> <p>Krītošu detaļu risks, ko izraisa vaļīgās skrūves! Krītošu detaļu izraisītas traumas.</p> <ul style="list-style-type: none"> ▶ Nostipriniet detaļu, lai tā nenokristu.
	<p>UZMANĪBU!</p> <p>Krītošu detaļu risks, ko izraisa vaļīgās skrūves! Citu ierīces detaļu bojājumi vai bojājumi, kas rodas klienta mājās, piem., apakšpuse.</p> <ul style="list-style-type: none"> ▶ Nostipriniet detaļu, lai tā nenokristu.

Prasība:

- ✔ Ierīces elektropadevei ir jābūt atvienotai.
- ✔ Ierīces iekšējām daļām ir jābūt izņemtām.
- ✔ Augšējā vira ir noņemta.
- ✔ Vidējā vira ir noņemta.

4.6.1 Durvju apakšējās viras noņemšana

- ▶ 1. Noņemiet saldētavas nodalījuma durvis (1).
- ▶ 2. Izskrūvējiet skrūvi (2).
- ▶ 3. Pagrieziet apakšējo viru uz āru (3).
- ▶ 4. Noņemiet apakšējo viru (4).

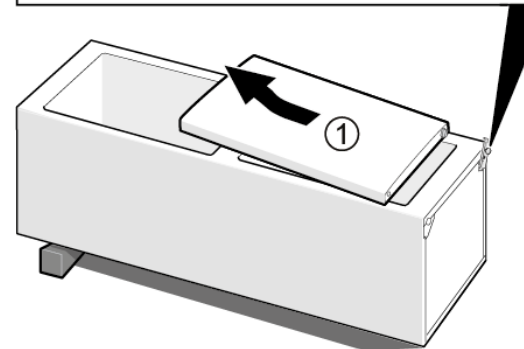
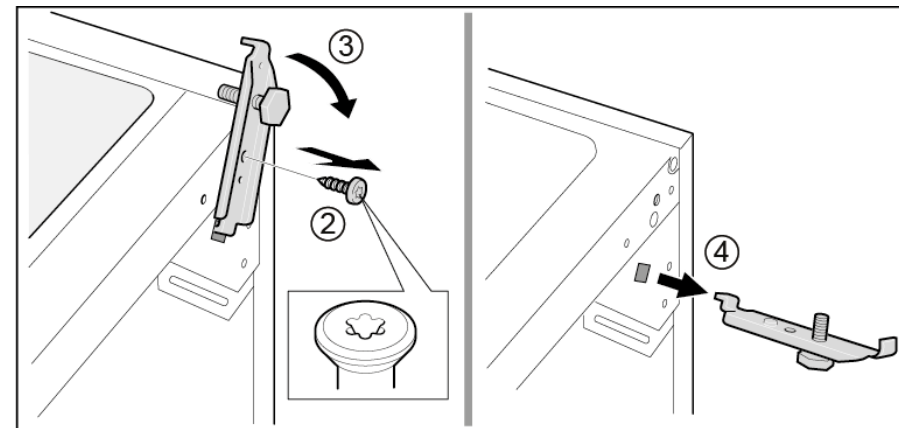

- ➡ Durvju apakšējā vira ir noņemta.

4.6.2 Durvju apakšējās viras uzstādīšana

- ▶ Uzstādiet apgrieztā kārtībā.

4.7 Plaukta nomaiņa

Prasība:

- ✔ Durvīm ir jābūt atvērtām.

4.7.1 Plaukta izņemšana

- ▶ Izvelciet plauktu.

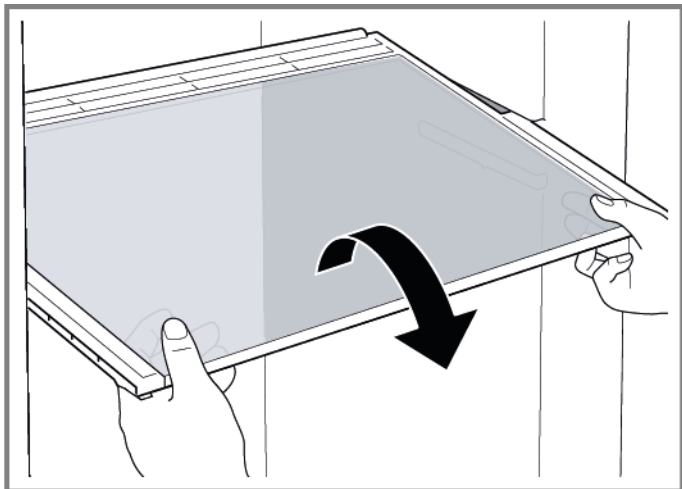

- ➡ Plaukts ir izņemts.

4.7.2 Plaukta uzstādīšana

- ▶ Uzstādiet apgrieztā kārtībā.

4.8 Pudeļu plaukta nomaiņa

Prasība:

- ✓ Durvīm ir jābūt atvērtām.

4.8.1 Pudeļu plaukta izņemšana

- ▶ Izvelciet pudeļu plauktu.

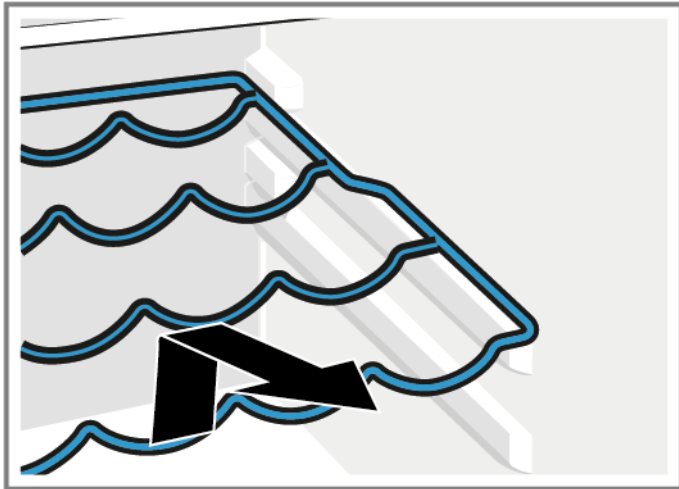

- ➡ Pudeļu plaukts ir izņemts.

4.8.2 Pudeļu plaukta uzstādīšana

- ▶ Uzstādiet apgrieztā kārtībā.

4.9 Durvju plaukta nomaiņa

Prasība:

- ✔ Durvīm ir jābūt atvērtām.

4.9.1 Durvju plaukta noņemšana

- ▶ Paceliet durvju plauktu uz augšu.

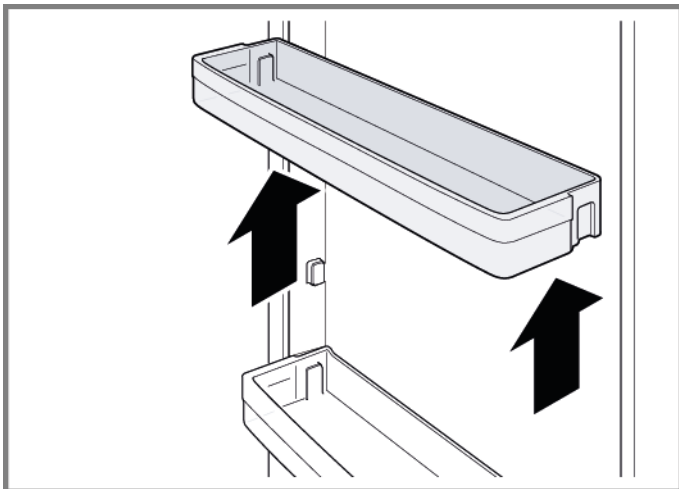

- ➡ Durvju plaukts ir noņemts.

4.9.2 Durvju plaukta uzstādīšana

- ▶ Uzstādiet apgrieztā kārtībā.

4.10 Regulējamā durvju plaukta nomaīņa

Prasība:

- ✓ Durvīm ir jābūt atvērtām.

4.10.1 Regulējamā durvju plaukta noņemšana

- ▶ Bīdīet augstumā regulējamo durvju plauktu uz augšu, līdz tas ir atbrīvots no turētāja.

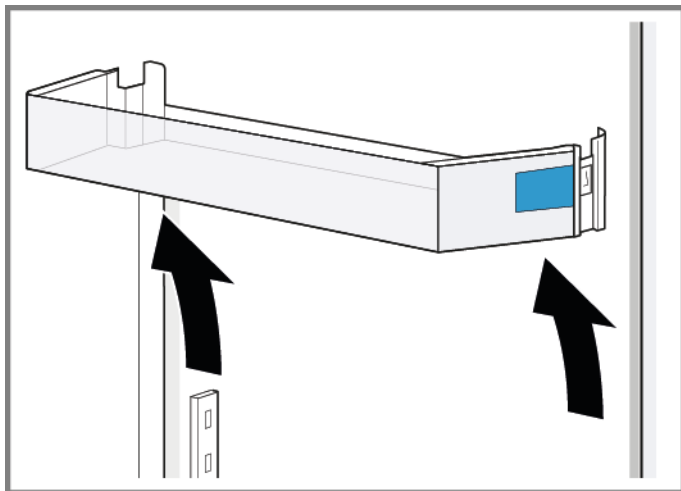

- ➡ Regulējamais durvju plaukts ir noņemts.

4.10.2 Regulējamā durvju plaukta uzstādīšana

- ▶ Uzstādiet apgrieztā kārtībā.

4.11 Saldētās pārtikas tvertnes nomaiņa

Prasība:

- ✔ Durvīm ir jābūt atvērtām.

4.11.1 Saldētās pārtikas tvertnes izņemšana

- ▶ 1. Pilnībā izvelciet saldētās pārtikas tvertni (1).
- ▶ 2. Izņemiet pārtikas tvertni (2).

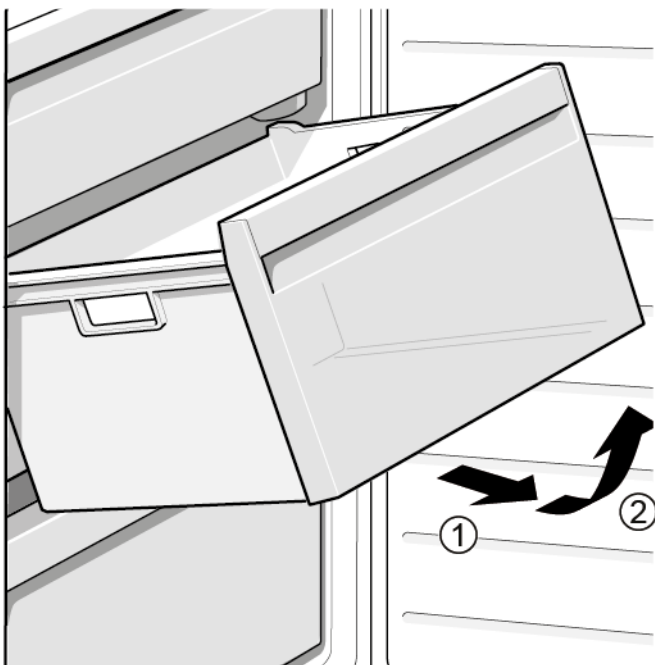

- ➡ Saldētās pārtikas tvertne ir izņemta.

4.11.2 Saldētās pārtikas tvertnes uzstādīšana

- ▶ Uzstādiet apgrieztā kārtībā.

4.12 Tvertnes nomaiņa

Prasība:

- ✓ Durvīm ir jābūt atvērtām.

4.12.1 Tvertnes izņemšana

- ▶ 1. Izņemiet ledusskapja apakšējo tvertni (1).
- ▶ 2. Izņemiet ledusskapja augšējo tvertni (2).

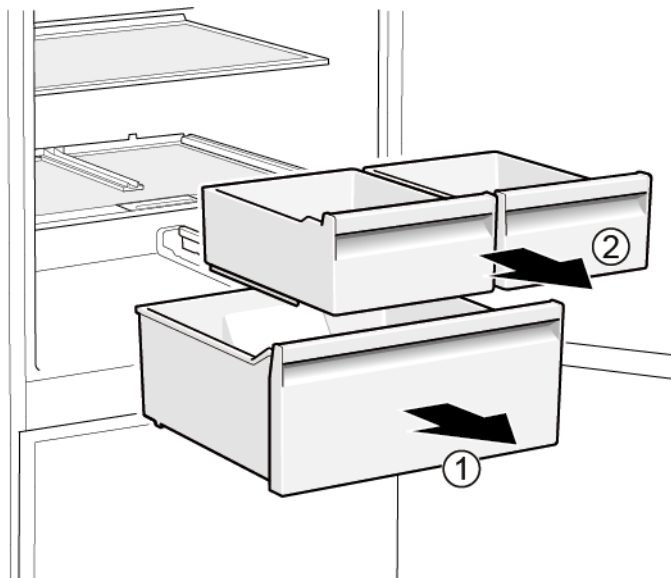

- ➡ Tvertnes ir izņemtas.

4.12.2 Tvertnes uzstādīšana

- ▶ Uzstādiet apgrieztā kārtībā.

4.13 Izvelkamās tvertnes nomaiņa

Prasība:

- ✓ Durvīm ir jābūt atvērtām.

4.13.1 Izvelkamās tvertnes izņemšana

- ▶ 1. Pilnībā izvelciet izvelkamo tvertni (1).
- ▶ 2. Izņemiet izvelkamo tvertni (2).

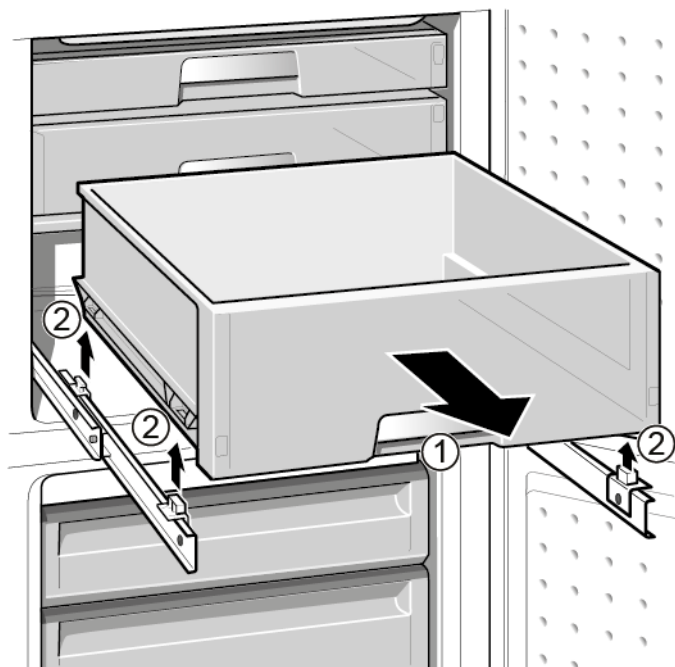

- ➡ Izvelkamā tvertne ir izņemta.

4.13.2 Izvelkamās tvertnes uzstādīšana

- ▶ Uzstādiet apgrieztā kārtībā.

4.14 LED starmeša nomaiņa

Speciāli rīki:

🔧 Īpašs darbarīks

[00342180]



Ierīcē ir LED gaismeklis, kam nav jāveic apkope.
Šo gaismekli drīkst remontēt tikai klientu apkalpošanas dienesta pārstāvis vai pilnvarots tehniķis!



⚠ BĪSTAMI

Elektrotrieciena risks spriegumaktīvu daļu dēļ!

Dzīvības apdraudējums nepareiza remonta izraisīta elektrotrieciena dēļ

- ▶ Elektriskās daļas ir jāremontē kvalificētam elektriķim.
- ▶ Pēc remonta ierīces drošība ir jāpārbauda atbilstīgi noteikumiem VDE 0701 vai valsts noteikumiem.



⚠ BĪSTAMI

Elektrotrieciena risks, ko rada spriegumaktīvas detaļas!

Nāvējošs elektrotrieciens

- ▶ Atvienojiet iekārtas no strāvas padeves vismaz 60 sekundes pirms labošanas sākšanas.



⚠ ESIET PIESARDZĪGI

Asas malas!

Grieztas brūces

- ▶ Lietojiet aizsargcimdus.

Prasība:

- ✓ Ierīces elektropadevei ir jābūt atvienotai.
- ✓ Durvīm ir jābūt atvērtām.

4.14.1 LED starmeša noņemšana

1. Izvelciet LED starmeti ar īpašo darbarīku (1).

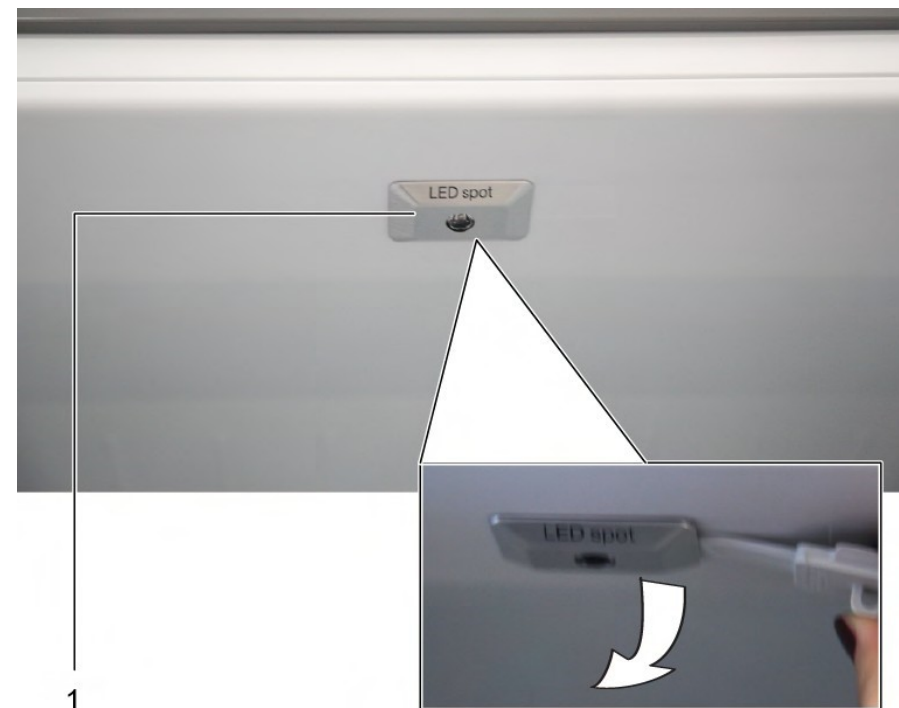

2. Atvienojiet LED starmeša elektriskos savienojumus.

➡ LED starmetis ir noņemts.

4.14.2 LED starmeša uzstādīšana

- ▶ Uzstādiet apgrieztā kārtībā.

4.15 Augšējā LED gaismekļa nomaīņa

Speciāli rīki:

- Plakanais skrūvgriezis Izmērs: 2,4 mm x 0,4 mm x 60 mm, komplektā [00341820]

i Ierīcē ir LED gaismeklis, kam nav jāveic apkope. Šo gaismekli drīkst remontēt tikai klientu apkalpošanas dienesta pārstāvis vai pilnvarots tehniķis!

⚠ BĪSTAMI
Elektrotrieciena risks spriegumaktīvu daļu dēļ!
 Dzīvības apdraudējums nepareiza remonta izraisīta elektrotrieciena dēļ

- ▶ Elektriskās daļas ir jāremontē kvalificētam elektriķim.
- ▶ Pēc remonta ierīces drošība ir jāpārbauda atbilstīgi noteikumiem VDE 0701 vai valsts noteikumiem.

⚠ BĪSTAMI
Elektrotrieciena risks, ko rada spriegumaktīvas detaļas!
 Nāvējošs elektrotrieciens

- ▶ Atvienojiet iekārtas no strāvas padeves vismaz 60 sekundes pirms labošanas sākšanas.

⚠ ESIET PIESARDZĪGI
Asas malas!
 Griezta brūces

- ▶ Lietojiet aizsargcimdus.

Prasība:

- ✓ Ierīces elektropadevei ir jābūt atvienotai.
- ✓ Durvīm ir jābūt atvērtām.
- ✓ Augšējām iekšējām daļām ir jābūt izņemtām.

4.15.1 LED gaismekļa noņemšana

1. Pārvietojiet LED gaismekli pa kreisi.



- ➡ LED gaismekļa elektriskais savienojums ir atvienots.

2. Atbrīvojiet LED gaismekļa āķus.

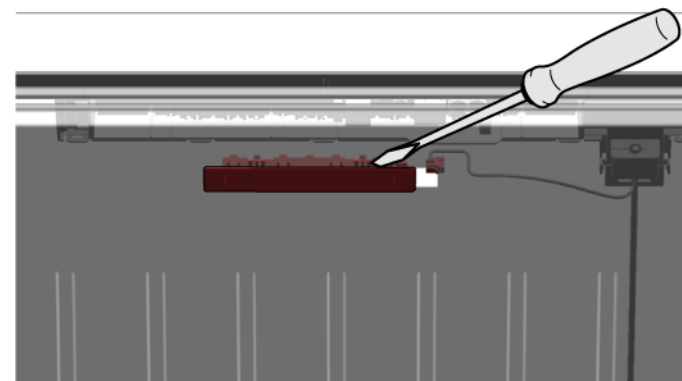

3. Lai noņemtu LED gaismekli, virziet to uz priekšu.

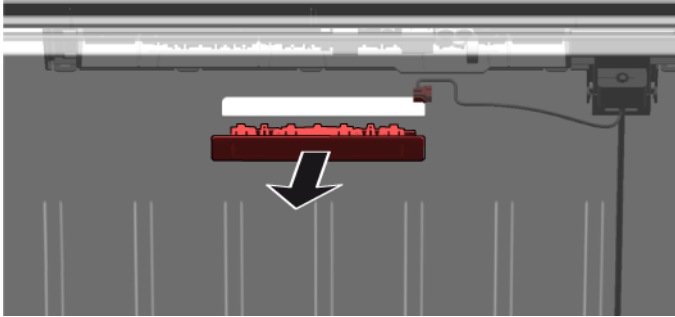

- ➔ LED gaismeklis ir noņemts.

4.15.2 Augšējā LED gaismekļa uzstādīšana

- ▶ Uzstādiet apgrieztā kārtībā.

4.16 Sānu LED apgaismes joslas nomaīņa

Speciāli rīki:

Piesūceknis Ø50 mm [00342224]

 Ierīcē ir LED gaismeklis, kam nav jāveic apkope. Šo gaismekli drīkst remontēt tikai klientu apkalpošanas dienesta pārstāvis vai pilnvarots tehniķis!

 **BĪSTAMI**
Elektrotrieciena risks spriegumaktīvu daļu dēļ!
 Dzīvības apdraudējums nepareiza remonta izraisīta elektrotrieciena dēļ

- ▶ Elektriskās daļas ir jāremontē kvalificētam elektriķim.
- ▶ Pēc remonta ierīces drošība ir jāpārbauda atbilstīgi noteikumiem VDE 0701 vai valsts noteikumiem.

 **BĪSTAMI**
Elektrotrieciena risks, ko rada spriegumaktīvas detaļas!
 Nāvējošs elektrotrieciens

- ▶ Atvienojiet iekārtas no strāvas padeves vismaz 60 sekundes pirms labošanas sākšanas.

 **ESIET PIESARDZĪGI**
Asas malas!
 Grieztas brūces

- ▶ Lietojiet aizsargcimdus.

Prasība:

- ✓ Ierīces elektropadevei ir jābūt atvienotai.
- ✓ Durvīm ir jābūt atvērtām.
- ✓ Ledusskapja nodalījuma plauktiem ir jābūt izņemtiem.

4.16.1 Sānu LED apgaismes joslas noņemšana

1. Uzspiediet piesūceknī uz sānu LED apgaismes joslas augšējās trešdaļas.



2. Piesūcekni kopā ar sānu LED apgaismes joslu pagriežot pavelciet uz priekšu.

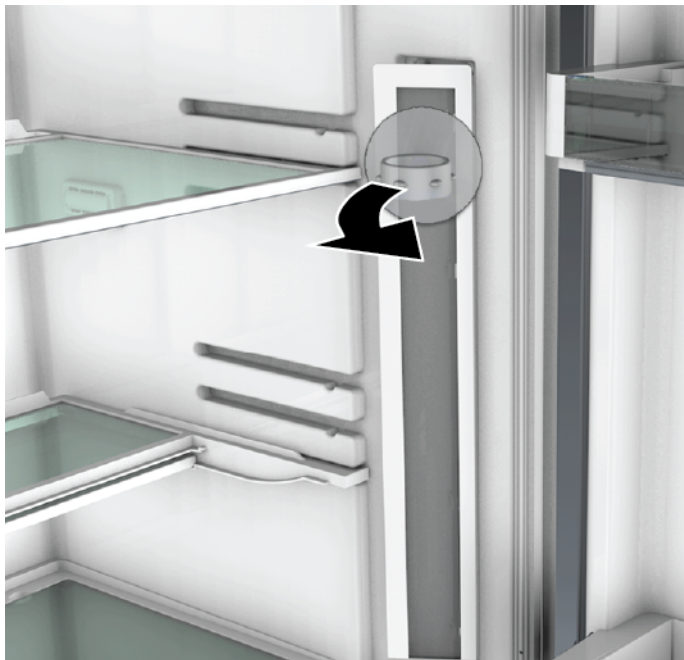

3. Atvienojiet sānu LED apgaismes joslas elektriskos savienojumus.
➡ Sānu LED apgaismes josla ir noņemta.

4.16.2 Sānu LED apgaismes joslas uzstādīšana

1. Izveidojiet sānu LED apgaismes joslas elektriskos savienojumus.
 2. Nostipriniet sānu LED apgaismes joslu vietā nodalījuma sienā (āķiem ir jānoklikšķ).
- ➡ Sānu LED apgaismes josla ir uzstādīta.

4.17 LED starmeša nomaiņa

Speciāli rīki:

- 🔧 Īpašs darbarīks [00342180]
- 🔧 Plakanais skrūvgriezis Izmērs: 2,4 mm x 0,4 mm x 60 mm, komplektā [00341820]

i Ierīcē ir LED gaismeklis, kam nav jāveic apkope. Šo gaismekli drīkst remontēt tikai klientu apkalpošanas dienesta pārstāvis vai pilnvarots tehniķis!

⚠ BĪSTAMI
Elektrotrieciena risks spriegumaktīvu daļu dēļ!
 Dzīvības apdraudējums nepareiza remonta izraisīta elektrotrieciena dēļ

- ▶ Elektriskās daļas ir jāremontē kvalificētam elektriķim.
- ▶ Pēc remonta ierīces drošība ir jāpārbauda atbilstīgi noteikumiem VDE 0701 vai valsts noteikumiem.

⚠ BĪSTAMI
Elektrotrieciena risks, ko rada spriegumaktīvas detaļas!
 Nāvējošs elektrotrieciens

- ▶ Atvienojiet iekārtas no strāvas padeves vismaz 60 sekundes pirms labošanas sākšanas.

⚠ ESIET PIESARDZĪGI
Asas malas!
 Grieztas brūces

- ▶ Lietojiet aizsargcimdus.

Prasība:

- ✔ Ierīces elektropadevei ir jābūt atvienotai.
- ✔ Durvīm ir jābūt atvērtām.
- ✔ Ledusskapja nodalījuma plauktiem ir jābūt izņemtiem.

4.17.1 LED starmeša noņemšana

1. Atbrīvojiet LED starmeša pārsegu.

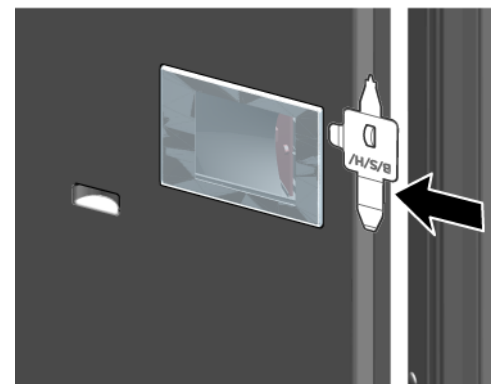

2. LED starmeša pārsegu vienlaikus velciet uz iekšu un prom no sienas.

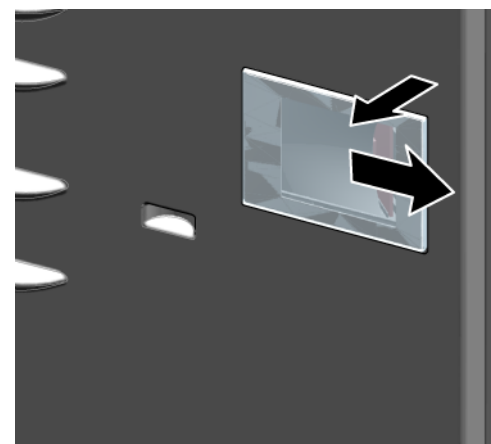

3. Atvienojiet LED starmeša moduli.

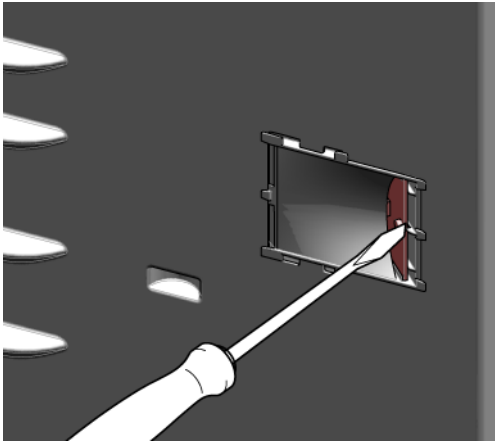

4. Atvienojiet LED starmeša elektrisko savienojumu.

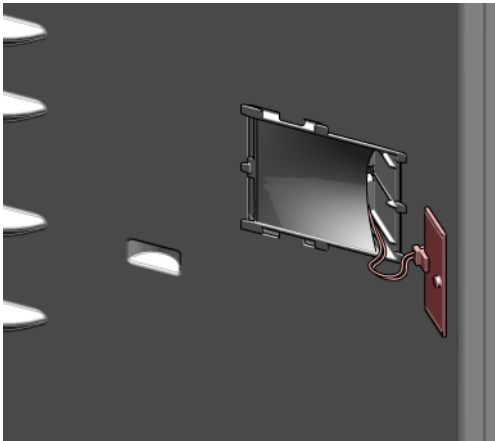





 LED starmetis ir noņemts.

4.17.2 LED starmeša uzstādīšana

▶ Uzstādiet apgrieztā kārtībā.

Informacija apie remontą - Šaldymo prietaiso ir šaldiklio kombinacija

 Dėl šio dokumento	409	4.8 Butelių padėklo keitimas.....	424
1.1 Svarbi informacija.....	409	4.8.1 Butelių padėklo išėmimas.....	424
1.1.1 Paskirtis.....	409	4.8.2 Butelių padėklo įdėjimas.....	424
1.2 Simbolių paaiškinimas.....	409	4.9 Durelių lentynos keitimas.....	425
1.2.1 Pavojaus lygiai.....	409	4.9.1 Durelių lentynos išėmimas.....	425
1.2.2 Pavojaus simboliai.....	409	4.9.2 Durelių lentynos įdėjimas.....	425
1.2.3 Įspėjimų struktūra.....	410	4.10 Reguliuojamos durelių lentynos keitimas.....	426
1.2.4 Bendrieji simboliai.....	410	4.10.1 Reguliuojamos durelių lentynos išėmimas.....	426
4.10.2 Reguliuojamos durelių lentynos įdėjimas.....	426	4.11 Šaldytų maisto produktų talpyklos keitimas.....	427
 Sauga	411	4.11.1 Šaldytų maisto produktų talpyklos išėmimas.....	427
2.1 Bendrosios saugos instrukcijos.....	411	4.11.2 Šaldytų maisto produktų talpyklos įdėjimas.....	427
2.1.1 Visi buitiniai prietaisai.....	411	4.12 Talpyklos keitimas.....	428
 Įrankiai ir pagalbinės priemonės	412	4.12.1 Talpyklos išėmimas.....	428
 Remontas	413	4.12.2 Talpyklos įdėjimas.....	428
4.1 Durelių tarpiklio keitimas.....	413	4.13 Ištraukiamos talpyklos keitimas.....	429
4.1.1 Durelių tarpiklio išėmimas.....	413	4.13.1 Ištraukiamos talpyklos išėmimas.....	429
4.1.2 Durelių tarpiklio įdėjimas.....	413	4.13.2 Ištraukiamos talpyklos įdėjimas.....	429
4.2 Durelių rankenos keitimas.....	416	4.14 LED apšvietimo lempučių keitimas.....	430
4.2.1 Durelių rankenos nuėmimas.....	416	4.14.1 LED apšvietimo lempučių išėmimas.....	430
4.2.2 Durelių rankenos tvirtinimas.....	416	4.14.2 LED apšvietimo lempučių montavimas.....	430
4.3 Durelių viršutinio vyro keitimas.....	417	4.15 Viršutinės LED keitimas.....	431
4.3.1 Viršutinio durelių vyro nuėmimas.....	417	4.15.1 LED lempučių išėmimas.....	431
4.3.2 Viršutinio durelių vyro uždėjimas.....	418	4.15.2 Viršutinės LED lempučių montavimas.....	432
4.4 Durelių viršutinio vyro keitimas (durelės su ekranu).....	419	4.16 Šoninės pailgos LED lempučių keitimas.....	433
4.4.1 Viršutinio durelių vyro nuėmimas.....	419	4.16.1 Šoninės pailgos LED lempučių išėmimas.....	433
4.4.2 Viršutinio durelių vyro uždėjimas.....	420	4.16.2 Šoninės pailgos LED lempučių montavimas.....	434
4.5 Vidurinio durelių vyro keitimas.....	421	4.17 LED apšvietimo lempučių keitimas.....	435
4.5.1 Vidurinio durelių vyro nuėmimas.....	421	4.17.1 LED apšvietimo lempučių išėmimas.....	435
4.5.2 Vidurinių durelių vyro uždėjimas.....	421	4.17.2 LED apšvietimo lempučių montavimas.....	436
4.6 Apatinio durelių vyro keitimas.....	422		
4.6.1 Apatinio durelių vyro nuėmimas.....	422		
4.6.2 Apatinio durelių vyro uždėjimas.....	422		
4.7 Lentynos keitimas.....	423		
4.7.1 Lentynos nuėmimas.....	423		
4.7.2 Lentynos įdėjimas.....	423		

i Dėl šio dokumento

1.1 Svarbi informacija

1.1.1 Paskirtis

Šios remonto nuorodos padeda naudotojui pataisyti prietaisus patiems pagal galiojantį ekologinio projektavimo reglamentą (2021 m. kovo mėn. redakcija).

Jose pateikta informacija, kaip pakeisti tam tikras atsargines dalis, įskaitant ir įspėjimus bei riziką.

Jei kiltų klausimų, kreipkitės į mūsų klientų aptarnavimo tarnybą. Mes atsakysime už žalą tik tuo atveju, jei bus tinkamai laikomasi remonto nuorodų.

1.2 Simbolių paaiškinimas

1.2.1 Pavojaus lygiai

Įspėjimo lygiai susideda iš simbolio ir signalinio žodžio. Signalinis žodis nurodo pavojaus sunkumą.





Įspėjimo lygis	Reikšmė
 PAVOJUS	Nepaisant įspėjamojo pranešimo, ištinka mirtis arba sunkūs sužalojimai.
 ĮSPĖJIMAS	Nepaisant įspėjamojo pranešimo, gali ištikti mirtis arba sunkūs sužalojimai.
 PERSPĖJIMAS	Nepaisant įspėjamojo pranešimo, galimi nedideli sužalojimai.
DĖMESIO!	Nepaisant įspėjamojo pranešimo, gali būti sugadintas turtas.

Lentelė 1: Pavojaus lygiai



1.2.2 Pavojaus simboliai

Pavojaus simboliai yra simboliniai atvaizdai, nurodantys pavojaus rūšį.

Šiame: dokumente naudojami tokie pavojaus simboliai

Pavojaus simbolis	Reikšmė
	Bendras įspėjamasis pranešimas
	Pavojinga elektros įtampa
	Sprogimo pavojus
	Įpjovimo pavojus
	Prispaudimo pavojus

i Dėl šio dokumento

Pavojaus simbolis	Reikšmė
	Pavojus dėl karštų paviršių
	Pavojus dėl stipraus magnetinio lauko
	Pavojus dėl nejonizuojančiosios spinduliuotės

Lentelė 2: Pavojaus simboliai

1.2.3 Įspėjimų struktūra

Šiame dokumente pateikiami įspėjimai yra standartizuotos išvaizdos ir standartizuotos struktūros.



	<p>⚠ PAVOJUS</p> <p>Pavojaus tipas ir šaltinis! Galimos pasekmės, jei nepaisoma pavojaus / įspėjimo.</p> <ul style="list-style-type: none"> ▶ Priemonės ir draudimai pavojui išvengti.
--	---





Šiame pavyzdyje parodytas įspėjimas, įspėjantis apie elektros smūgį dėl dalių su įtampa. Paminėta priemonė, kaip išvengti pavojaus.

	<p>⚠ PAVOJUS</p> <p>Elektros smūgio pavojus dėl dalių, kuriose yra įtampa! Mirtis dėl elektros smūgio</p> <ul style="list-style-type: none"> ▶ Prieš pradėdami remontą, ne mažiau kaip prieš 60 sekundžių atjunkite prietaisus nuo elektros tiekimo.
---	---

1.2.4 Bendrieji simboliai

Šiame dokumente naudojami tokie bendrieji simboliai:

Bendr. simbolis	Reikšmė
	Žymi specialų patarimą (tekstas ir (arba) grafika)
	Žymi paprastą patarimą (tik tekstas)
	Žymi nuorodą į vaizdo pamoką

Bendr. simbolis	Reikšmė
	Žymi reikalingus įrankius
	Žymi reikalingas prielaidas
	Žymi sąlygą (jei ..., tai ...)
	Žymi rezultatą
[Paleisti]	Žymi klavišą arba ekrano mygtuką
[00123456]	Žymi dalies numerį
Būsena	Žymi rodomą tekstą / langą (prietaiso ekrane)

Lentelė 3: Bendrieji simboliai

2.1 Bendrosios saugos instrukcijos

2.1.1 Visi būtiniai prietaisai

Elektros smūgio pavojus dėl dalių, kuriose yra įtampa!

- Elektrinių konstrukcinių dalių remonto klaidos gali sukelti elektros smūgį!
- Prieš pradėdami dirbti, ne mažiau kaip prieš 60 sekundžių atjunkite prietaisą nuo maitinimo.
- Po remonto pasirūpinkite, kad būtų atliktas saugos bandymas pagal VDE 0701 arba šalyje galiojančius reglamentus.

Pavojus susižeisti į aštrias briaunas!

- Mūvėkite apsaugines pirštines.

Prispaudimo rizika remonto, einamosios techninės priežiūros, sutrikimų šalinimo ir techninės priežiūros metu dėl sunkių ir judančių konstrukcinių dalių

- Avėkite apsauginius batus.
- Apsaugokite sunkias konstrukcines dalis, kad jos nenukristų.
- Neartinkite kūno dalių prie judančių konstrukcinių dalių.





Rizika prietaiso saugai / veikimui!

- Naudokite tik originalias atsargines dalis.

Elektrostatškai jautrių konstrukcinių dalių (ESD) pažeidimo rizika!

- Nelieskite modulių, o taip pat ir jų jungčių bei laidininkų kelių.

Įrankiai ir pagalbinės priemonės

Paskyrimas	Išsami informacija	Vaizdai
Apsauginis audinys [00342013]	60 cm x 50 cm	
Atsuktuvus su įpjovomis	Mentė 2,4 mm x 0,4 mm x 60 mm, rinkinyje [00341820]	
Specialus įrankis [00342180]		
Siurbtukas [00342224]	Ø50 mm	
„Torx“ antgalis TX20 [00340865]	6,3 mm (1/4 col.)	
Atsuktuvus su įpjovomis	Mentė 10 mm x 1,6 mm x 200 mm	

4.1 Durelių tarpiklio keitimas

Reikalavimas.

- ✔ Durelės turi būti atidarytos.

4.1.1 Durelių tarpiklio išėmimas

1. Išimkite durelių tarpiklį iš griovelio dešiniajame ir kairiajame kampe.





2. Ištraukite durelių tarpiklį iš griovelio.



- ➡ Durelių tarpiklis išimtas.

4.1.2 Durelių tarpiklio įdėjimas

	Naujo durelių tarpiklio storis gali šiek tiek skirtis nuo seno durelių tarpiklio storio. Dėl to durelės vis tiek užsidarys, o tarpiklį bus galima naudoti ilgai.
	Jei jūsų prietaiso vyriai arba vyrio priedai reguliuojami, uždarymo funkciją vėliau galima optimizuoti.
	Nedidelės šoninės skylutės durelių tarpiklyje turi savo funkciją (reikalingos ventiliacijai). Tai nėra gamybinis brokas.

1. Patikrinkite griovelį, ar nėra tarpiklių galinčių pažeisti vietų.

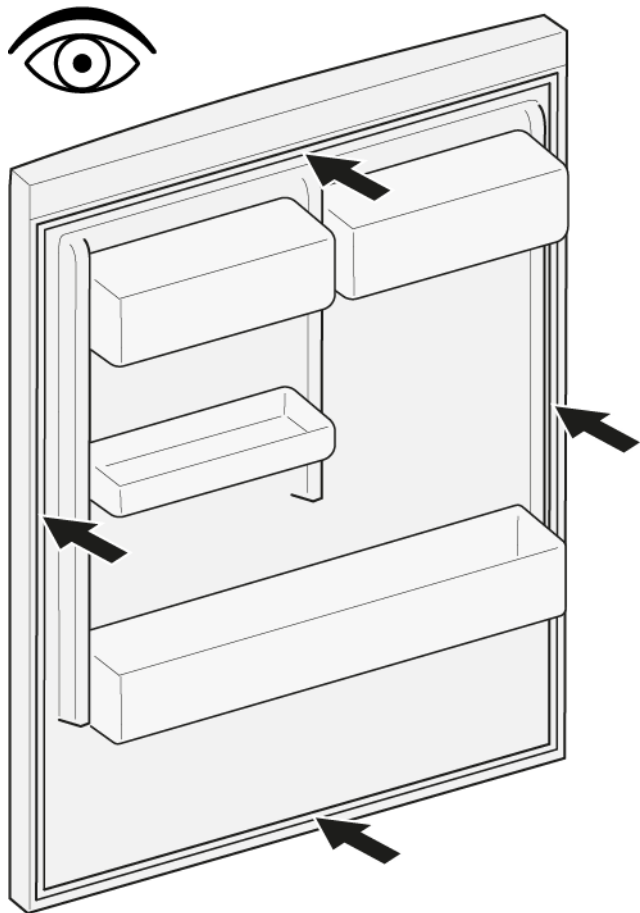

4. Įspauskite tarpiklio kampus viršuje ir apačioje į griovelį.

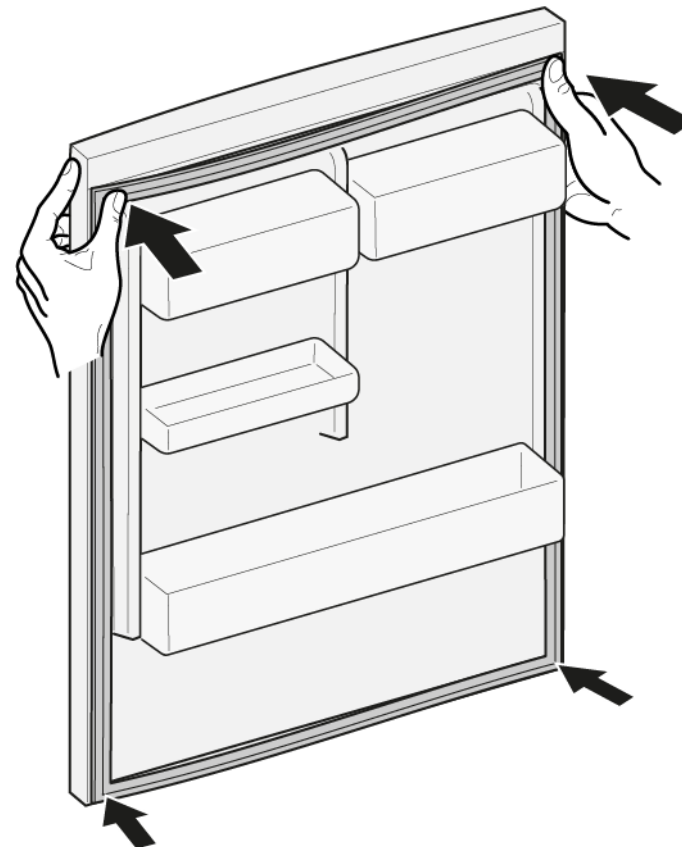

2.  Jei tarpiklio griovelis pažeistas.
- Kreipkitės į klientų aptarnavimo tarnybą.

3.  Nedidelės durelių tarpiklio deformacijos yra įprastas požymis ir nepaveikia tarpiklio funkcinių savybių. Prieš įdedant durelių tarpiklį į prietaisą, rekomenduojama jį ištiesinti.

Pašildykite durelių tarpiklių plaukų džiovintuvu arba karštu vandeniu ir iš naujo suteikite formą rankiniu būdu.

5. Po truputį įspauskite į griovelį visą tarpiklį.

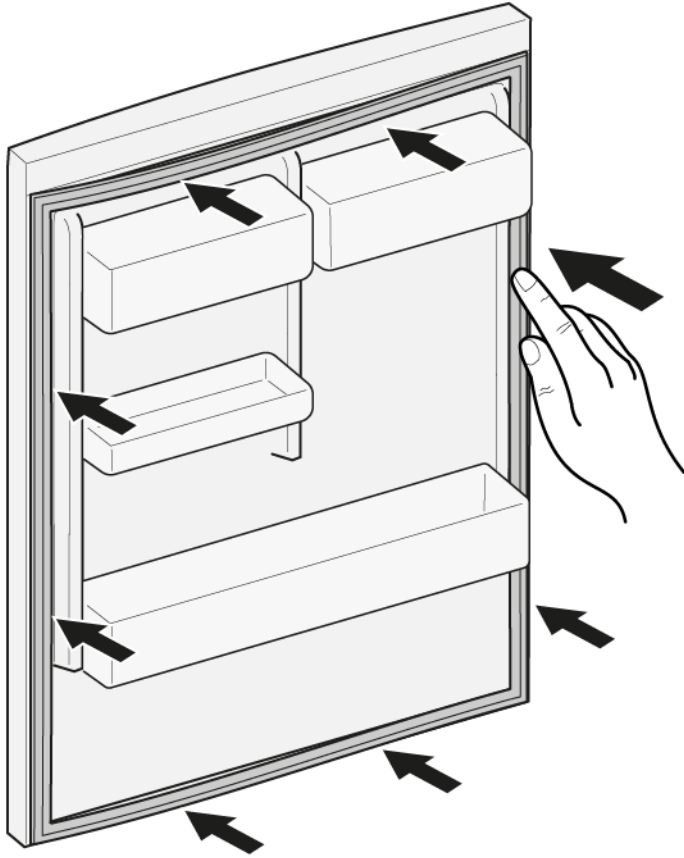

 Durelių tarpiklis įdėtas.

4.2 Durelių rankenos keitimas

Specialūs įrankiai.

- „Torx“ antgalis TX20 6,3 mm (1/4 col.) [00340865]
- Atsuktuvus su įpjovomis Mentė 10 mm x 1,6 mm x 200 mm

Reikalavimas.

- ✓ Prietaisas turi būti atjungtas nuo maitinimo šaltinio.
- ✓ Durelės turi būti atidarytos.

4.2.1 Durelių rankenos nuėmimas

- ▶ 1. Išimkite du varžtų gaubtelius (1).
- ▶ 2. Išsukite du varžtus (2).
- ▶ 3. Nuimkite durelių rankeną (3).

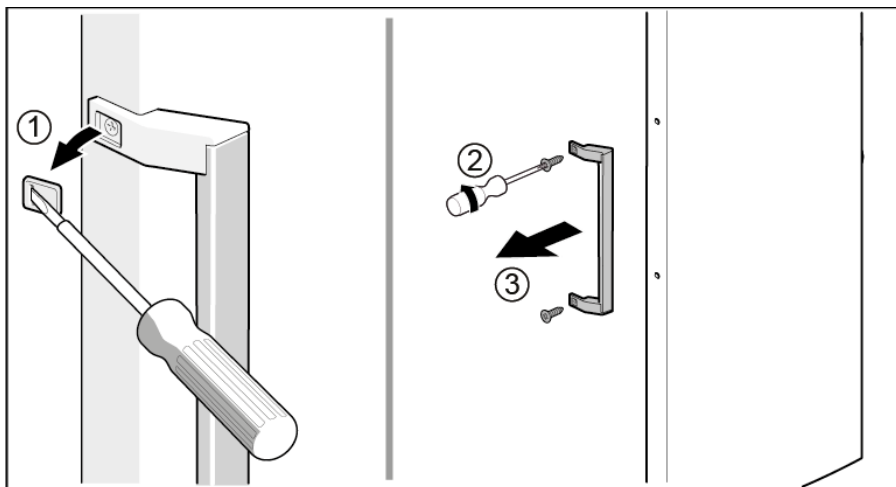

➔ Durelių rankena nuimta.



Antrą durelių rankenėlę galima nuimti tokiu pačiu būdu.

4.2.2 Durelių rankenos tvirtinimas

- ▶ Uždėkite atvirkščia eilės tvarka.

4.3 Durelių viršutinio vyro keitimas

Specialūs įrankiai.

„Torx“ antgalis TX20

6,3 mm (1/4 col.)

[00340865]

	<p style="text-align: center;">! SPĖJIMAS</p> <p>Sunkūs ir dideli prietaisai! Nugaros ir raumenų sužalojimai</p> <ul style="list-style-type: none"> ▶ Prietaiso dureles nuimti gali tik apmokyti specialistai. ▶ Norint perkelti prietaisą į kitą vietą, reikalingi du žmonės. ▶ Naudokite tik tinkamus įrankius ir įrangą.
	<p style="text-align: center;">! PERSPĖJIMAS</p> <p>Aštrios briaunos! Galima įsipjauti</p> <ul style="list-style-type: none"> ▶ Mūvėkite apsaugines pirštines.
	<p style="text-align: center;">! SPĖJIMAS</p> <p>Paverstų prietaisų slydimas! Galimi kaulų lūžiai ir prispaudimai</p> <ul style="list-style-type: none"> ▶ Apsaugokite prietaisus, kad jie nepaslystų.
	<p style="text-align: center;">! PERSPĖJIMAS</p> <p>Pavojus, kad atpalaidavus varžtus dalys nukris! Krentančios dalys gali sužeisti.</p> <ul style="list-style-type: none"> ▶ Apsaugokite konstrukcinę dalį, kad ji nenukristų.
	<p style="text-align: center;">DĖMESIO!</p> <p>Pavojus, kad atpalaidavus varžtus dalys nukris! Gali būti sugadintos kitos prietaiso dalys arba kliento namai, pvz., grindys.</p> <ul style="list-style-type: none"> ▶ Apsaugokite konstrukcinę dalį, kad ji nenukristų.

Reikalavimas.

- ✓ Prietaisas turi būti atjungtas nuo maitinimo šaltinio.
- ✓ Prietaiso vidiniai tvirtinimo elementai turi būti nuimti.

4.3.1 Viršutinio durelių vyro nuėmimas

1. Paguldyskite prietaisą ant galinės pusės.

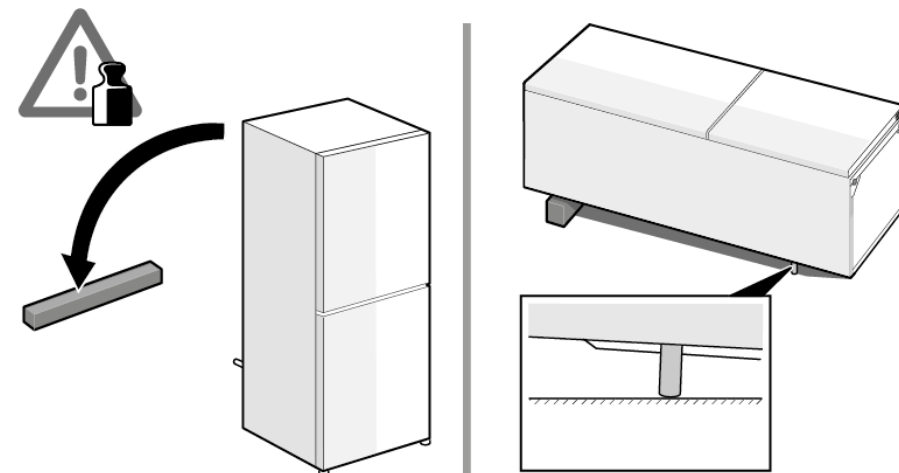

2. 1. Spustelėkite viršutinio vairo dangtelį abiejose pusėse (1).
2. Atkelkite viršutinio vairo dangtelį (2).
3. Pasukite vairo dangtelį (3).
4. Nuimkite viršutinio vairo dangtelį (4).
5. Išsukite du varžtus (5).
6. Nuimkite viršutinį vairą (6).

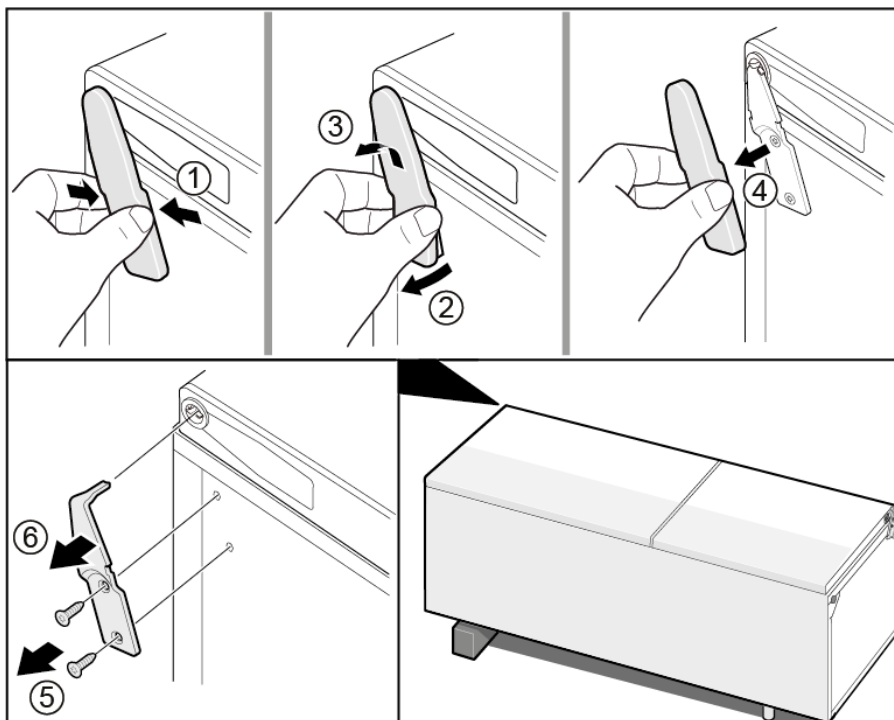

 Viršutinis vairas nuimtas.

4.3.2 Viršutinio durelių vairo uždėjimas

- ▶ Uždėkite atvirkščia eilės tvarka.





4.4 Durelių viršutinio vyro keitimas (durelės su ekranu)

Specialūs įrankiai.

„Torx“ antgalis TX20

6,3 mm (1/4 col.)

[00340865]

	<p style="text-align: center;">⚠️ ĮSPĖJIMAS</p> <p>Sunkūs ir dideli prietaisai! Nugaros ir raumenų sužalojimai</p> <ul style="list-style-type: none"> ▶ Prietaiso dureles nuimti gali tik apmokyti specialistai. ▶ Norint perkelti prietaisą į kitą vietą, reikalingi du žmonės. ▶ Naudokite tik tinkamus įrankius ir įrangą.
	<p style="text-align: center;">⚠️ PERSPĖJIMAS</p> <p>Aštrios briaunos! Galima įsipjauti</p> <ul style="list-style-type: none"> ▶ Mūvėkite apsaugines pirštines.
	<p style="text-align: center;">⚠️ ĮSPĖJIMAS</p> <p>Paverstų prietaisų slydimas! Galimi kaulų lūžiai ir prispaudimai</p> <ul style="list-style-type: none"> ▶ Apsaugokite prietaisus, kad jie nepaslystų.
	<p style="text-align: center;">⚠️ PERSPĖJIMAS</p> <p>Pavojus, kad atpalaidavus varžtus dalys nukris! Krentančios dalys gali sužeisti.</p> <ul style="list-style-type: none"> ▶ Apsaugokite konstrukcinę dalį, kad ji nenukristų.
	<p style="text-align: center;">⚠️ DĖMESIO!</p> <p>Pavojus, kad atpalaidavus varžtus dalys nukris! Gali būti sugadintos kitos prietaiso dalys arba kliento namai, pvz., grindys.</p> <ul style="list-style-type: none"> ▶ Apsaugokite konstrukcinę dalį, kad ji nenukristų.

	<p style="text-align: center;">⚠️ PAVOJUS</p> <p>Elektros smūgio pavojus dėl dalių, kuriose yra įtampa! Pavojus gyvybei dėl elektros smūgio netinkamo remonto atveju</p> <ul style="list-style-type: none"> ▶ Elektrines dalis remontuoti turi kvalifikuoti elektrikai. ▶ Po remonto pasirūpinkite, kad būtų atliktas saugos bandymas pagal VDE 0701 arba šalyje galiojančius reglamentus.
---	--

	<p style="text-align: center;">⚠️ PAVOJUS</p> <p>Elektros smūgio pavojus dėl dalių, kuriose yra įtampa! Mirtis dėl elektros smūgio</p> <ul style="list-style-type: none"> ▶ Prieš pradėdami remontą, ne mažiau kaip prieš 60 sekundžių atjunkite prietaisus nuo elektros tiekimo.
---	--

Reikalavimas.

- ✓ Prietaisas turi būti atjungtas nuo maitinimo šaltinio.
- ✓ Prietaiso vidiniai tvirtinimo elementai turi būti nuimti.

4.4.1 Viršutinio durelių vyro nuėmimas

1. Paguldykite prietaisą ant galinės pusės.

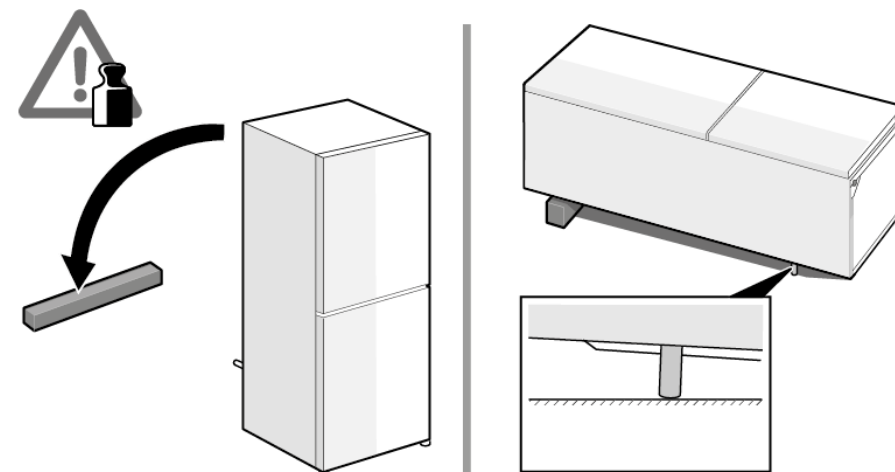

Remontas

2. 1. Nuimkite viršutinio vyro dangtelį (1).
2. Nuimkite kabelių dėžutės dangtelį (2).
3. Atjunkite elektros jungtį (3).
4. Atsukite įžeminimo jungties varžtą (4).
5. Nuimkite kabelio apsaugą (5).
6. Išsukite varžtą (6).

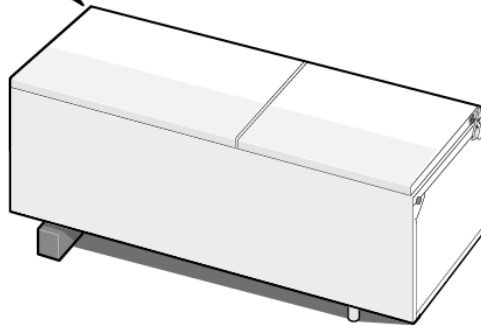
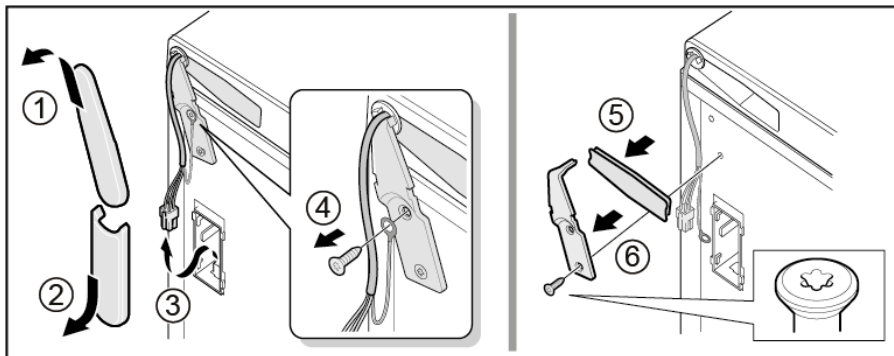

 Viršutinis vyras nuimtas.

4.4.2 Viršutinio durelių vyro uždėjimas

- ▶ Uždėkite atvirkščia eilės tvarka.

4.5 Vidurinio durelių vyrio keitimas

Specialūs įrankiai.

„Torx“ antgalis TX20

6,3 mm (1/4 col.)

[00340865]

	<p style="text-align: center;">⚠️ ĮSPĖJIMAS</p> <p>Sunkūs ir dideli prietaisai! Nugaros ir raumenų sužalojimai</p> <ul style="list-style-type: none"> ▶ Prietaiso dureles nuimti gali tik apmokyti specialistai. ▶ Norint perkelti prietaisą į kitą vietą, reikalingi du žmonės. ▶ Naudokite tik tinkamus įrankius ir įrangą.
	<p style="text-align: center;">⚠️ PERSPĖJIMAS</p> <p>Aštrios briaunos! Galima įsipjauti</p> <ul style="list-style-type: none"> ▶ Mūvėkite apsaugines pirštines.
	<p style="text-align: center;">⚠️ ĮSPĖJIMAS</p> <p>Paverstų prietaisų slydimas! Galimi kaulų lūžiai ir prispaudimai</p> <ul style="list-style-type: none"> ▶ Apsaugokite prietaisus, kad jie nepaslystų.
	<p style="text-align: center;">⚠️ PERSPĖJIMAS</p> <p>Pavojus, kad atpalaidavus varžtus dalys nukris! Krentančios dalys gali sužeisti.</p> <ul style="list-style-type: none"> ▶ Apsaugokite konstrukcinę dalį, kad ji nenukristų.
	<p style="text-align: center;">⚠️ DĖMESIO!</p> <p>Pavojus, kad atpalaidavus varžtus dalys nukris! Gali būti sugadintos kitos prietaiso dalys arba kliento namai, pvz., grindys.</p> <ul style="list-style-type: none"> ▶ Apsaugokite konstrukcinę dalį, kad ji nenukristų.

Reikalavimas.

- ✔️ Prietaisas turi būti atjungtas nuo maitinimo šaltinio.
- ✔️ Prietaiso vidiniai tvirtinimo elementai turi būti nuimti.
- ✔️ Durelių viršutinis vyris nuimtas.

4.5.1 Vidurinio durelių vyrio nuėmimas

- ▶ 1. Nuimkite šaldytuvo skyriaus dureles (1).
- ▶ 2. Išsukite du varžtus (2).
- ▶ 3. Nuimkite vidurinį vyrį (3).

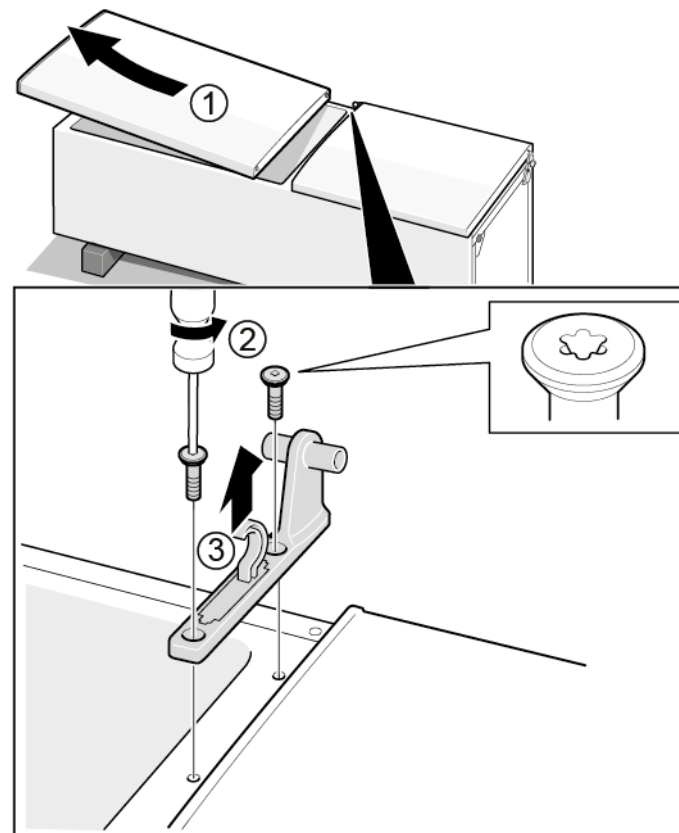

➡ Vidurinis vyris nuimtas.

4.5.2 Vidurinių durelių vyrio uždėjimas

- ▶ Uždėkite atvirkščia eilės tvarka.

4.6 Apatinio durelių vyrio keitimas

Specialūs įrankiai.

„Torx“ antgalis TX20

6,3 mm (1/4 col.)

[00340865]

	<p style="text-align: center;">⚠️ ĮSPĖJIMAS</p> <p>Sunkūs ir dideli prietaisai! Nugaros ir raumenų sužalojimai</p> <ul style="list-style-type: none"> ▶ Prietaiso dureles nuimti gali tik apmokyti specialistai. ▶ Norint perkelti prietaisą į kitą vietą, reikalingi du žmonės. ▶ Naudokite tik tinkamus įrankius ir įrangą.
	<p style="text-align: center;">⚠️ PERSPĖJIMAS</p> <p>Aštrios briaunos! Galima įsipjauti</p> <ul style="list-style-type: none"> ▶ Mūvėkite apsaugines pirštines.
	<p style="text-align: center;">⚠️ ĮSPĖJIMAS</p> <p>Paverstų prietaisų slydimas! Galimi kaulų lūžiai ir prispaudimai</p> <ul style="list-style-type: none"> ▶ Apsaugokite prietaisus, kad jie nepaslystų.
	<p style="text-align: center;">⚠️ PERSPĖJIMAS</p> <p>Pavojus, kad atpalaidavus varžtus dalys nukris! Krentančios dalys gali sužeisti.</p> <ul style="list-style-type: none"> ▶ Apsaugokite konstrukcinę dalį, kad ji nenukristų.
	<p style="text-align: center;">⚠️ DĖMESIO!</p> <p>Pavojus, kad atpalaidavus varžtus dalys nukris! Gali būti sugadintos kitos prietaiso dalys arba kliento namai, pvz., grindys.</p> <ul style="list-style-type: none"> ▶ Apsaugokite konstrukcinę dalį, kad ji nenukristų.

Reikalavimas.

- ✔️ Prietaisas turi būti atjungtas nuo maitinimo šaltinio.
- ✔️ Prietaiso vidiniai tvirtinimo elementai turi būti nuimti.
- ✔️ Viršutinis vyris nuimtas.
- ✔️ Vidurinis vyris nuimtas.

4.6.1 Apatinio durelių vyrio nuėmimas

- ▶ 1. Nuimkite šaldiklio skyriaus dureles (1).
- ▶ 2. Išsukite varžtą (2).
- ▶ 3. Pasukite apatinį vyrį į išorę (3).
- ▶ 4. Nuimkite apatinį vyrį (4).

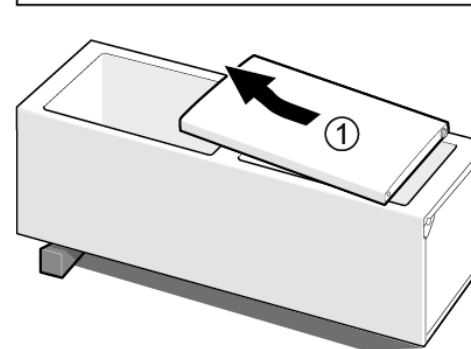
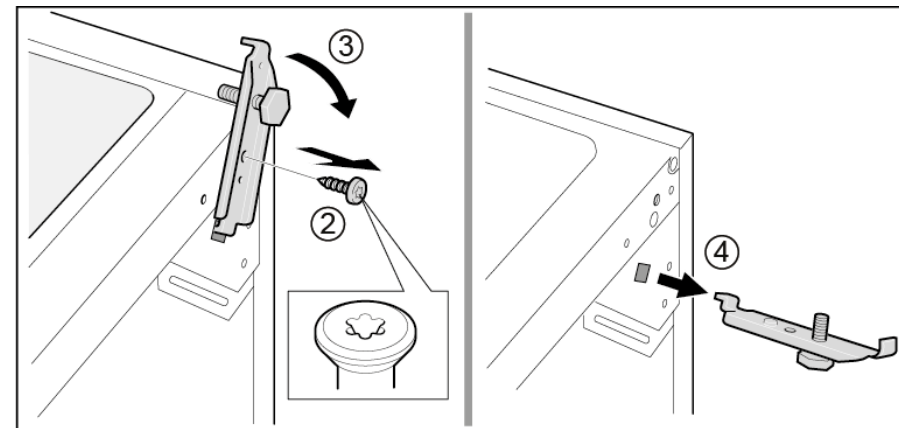

- ➡️ Apatinis durelių vyris nuimtas.

4.6.2 Apatinio durelių vyrio uždėjimas

- ▶ Uždėkite atvirkščia eilės tvarka.

4.7 Lentynos keitimas

Reikalavimas.

- ✔ Durelės turi būti atidarytos.

4.7.1 Lentynos nuėmimas

- ▶ Ištraukite lentyną.

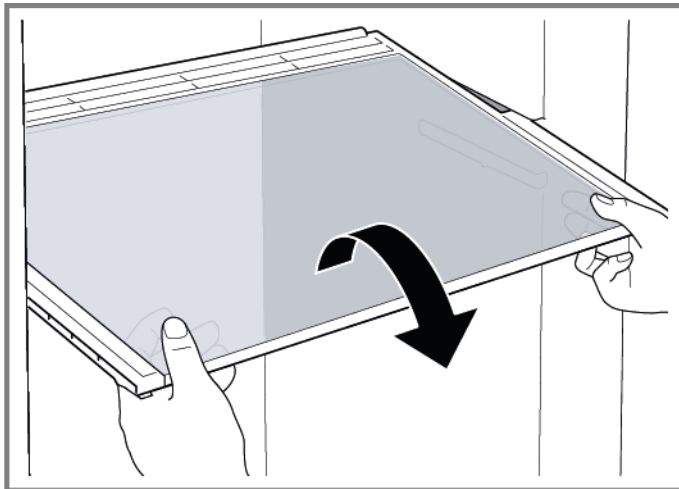

- ➡ Lentyna išimta.

4.7.2 Lentynos įdėjimas

- ▶ Uždėkite atvirkščia eilės tvarka.

4.8 Butelių padėklo keitimas

Reikalavimas.

- ✔ Durelės turi būti atidarytos.

4.8.1 Butelių padėklo išėmimas

- ▶ Ištraukite butelių padėklą.

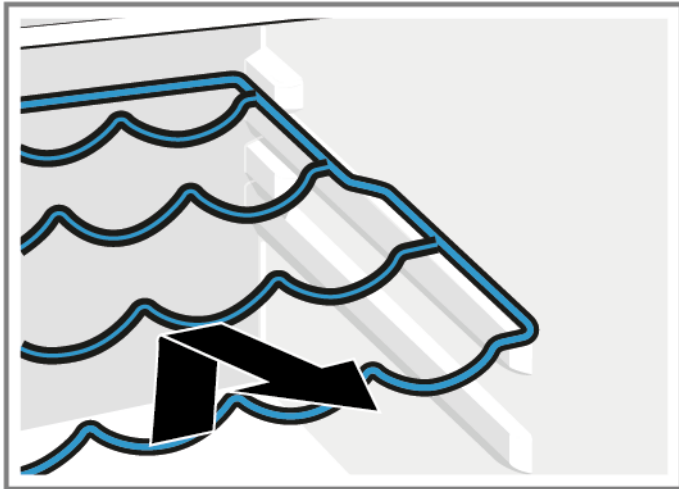

- ➡ Butelių padėklas išimtas.

4.8.2 Butelių padėklo įdėjimas

- ▶ Uždėkite atvirkščia eilės tvarka.

4.9 Durelių lentynos keitimas

Reikalavimas.

- ✔ Durelės turi būti atidarytos.

4.9.1 Durelių lentynos išėmimas

- ▶ Pakelkite durelių lentyną į viršų.

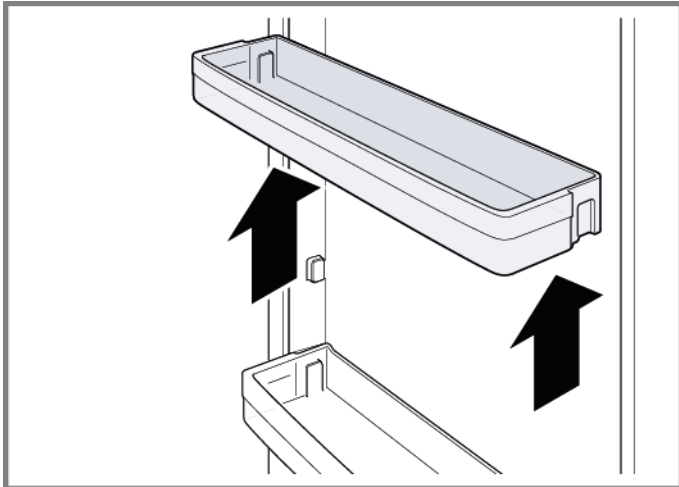

- ➡ Durelių lentyna išimta.

4.9.2 Durelių lentynos įdėjimas

- ▶ Uždėkite atvirkščia eilės tvarka.

4.10 Reguliuojamos durelių lentynos keitimas

Reikalavimas.

- ✔ Durelės turi būti atidarytos.

4.10.1 Reguliuojamos durelių lentynos išėmimas

- ▶ Kelkite reguliuojamo aukščio durelių lentyną į viršų, kol ji atsifiksuos iš laikiklio.

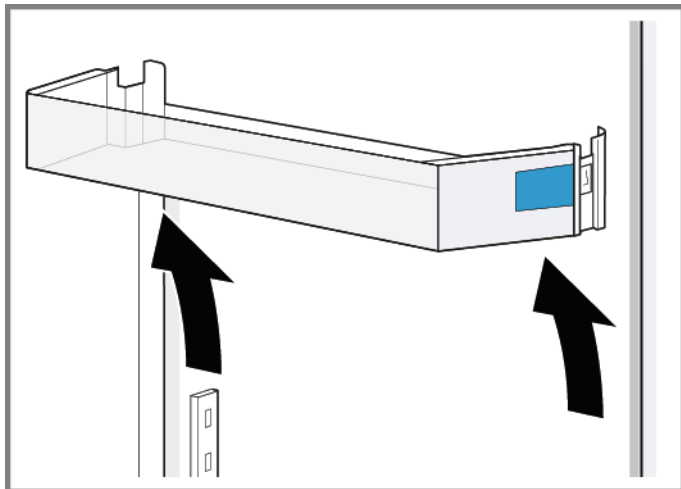

- ➡ Reguliuojama durelių lentyna išimta.

4.10.2 Reguliuojamos durelių lentynos įdėjimas

- ▶ Uždėkite atvirkščia eilės tvarka.

4.11 Šaldytų maisto produktų talpyklos keitimas

Reikalavimas.

- ✔ Durelės turi būti atidarytos.

4.11.1 Šaldytų maisto produktų talpyklos išėmimas

- ▶ 1. Ištraukite šaldytų maisto produktų talpyklą iki pat galo (1).
- ▶ 2. Išimkite maisto produktų talpyklą (2).

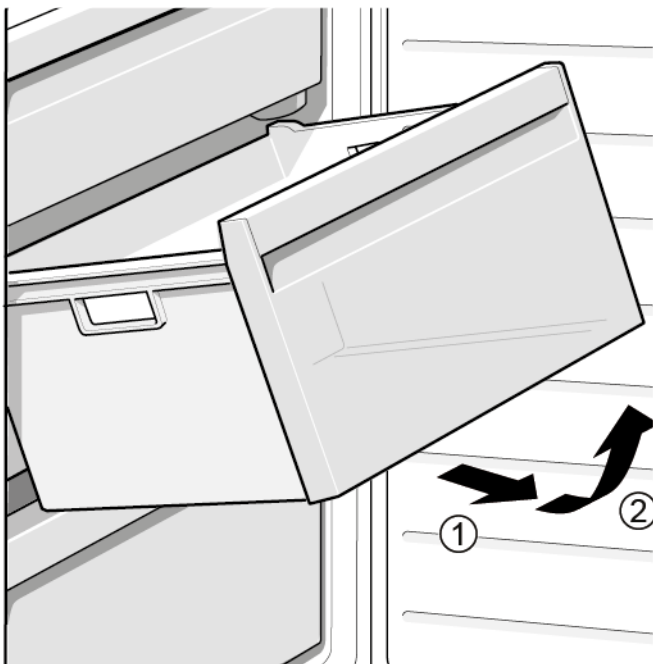

- ➡ Šaldytų maisto produktų talpykla išimta.

4.11.2 Šaldytų maisto produktų talpyklos įdėjimas

- ▶ Uždėkite atvirksčia eilės tvarka.

4.12 Talpyklos keitimas

Reikalavimas.

- ✔ Durelės turi būti atidarytos.

4.12.1 Talpyklos išėmimas

- ▶ 1. Ištraukite apatinę šaldytuvo talpyklą (1).
- ▶ 2. Ištraukite viršutinę šaldytuvo talpyklą (2).

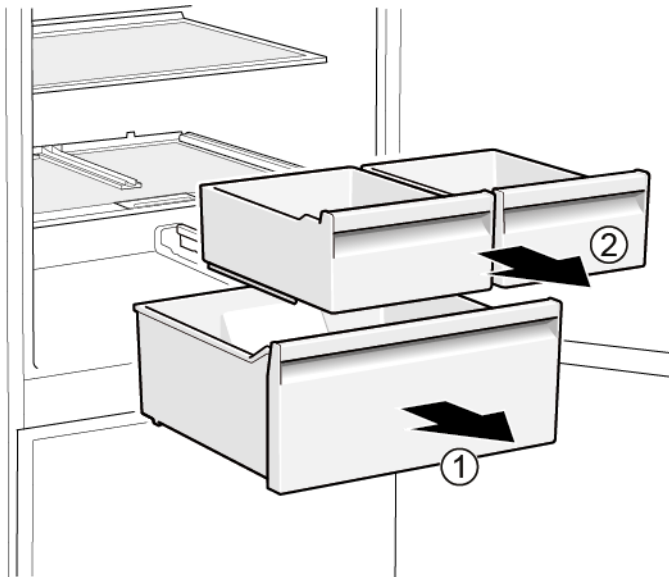

- ➡ Talpyklos išimtos.

4.12.2 Talpyklos įdėjimas

- ▶ Uždėkite atvirkščia eilės tvarka.

4.13 Ištraukiamos talpyklos keitimas

Reikalavimas.

- ✔ Durelės turi būti atidarytos.

4.13.1 Ištraukiamos talpyklos išėmimas

- ▶ 1. Ištraukite ištraukiamą talpyklą iki pat galo (1).
- ▶ 2. Išimkite ištraukiamą talpyklą (2).

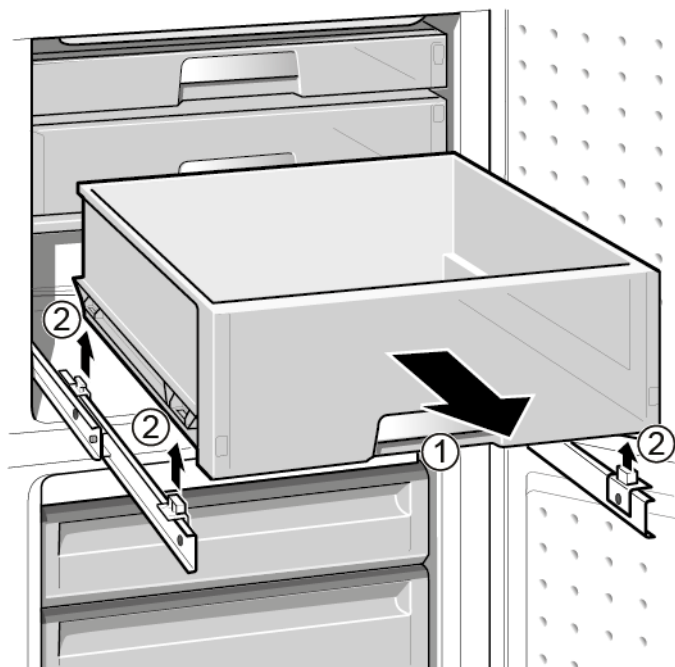

- ➡ Ištraukiama talpykla išimta.

4.13.2 Ištraukiamos talpyklos įdėjimas

- ▶ Uždėkite atvirkščia eilės tvarka.

4.14 LED apšvietimo lempučių keitimas

Specialūs įrankiai.

Specialus įrankis [00342180]

i Jūsų prietaise įrengta techninės priežiūros nereikalaujanti LED lempučių. Šią lempučių gali taisyti tik klientų aptarnavimo tarnybos specialistai arba įgalioti technikai!

⚠ PAVOJUS
Elektros smūgio pavojus dėl dalių, kuriose yra įtampa!
Pavojus gyvybei dėl elektros smūgio netinkamo remonto atveju

- ▶ Elektrinės dalys remontuoti turi kvalifikuoti elektrikai.
- ▶ Po remonto pasirūpinkite, kad būtų atliktas saugos bandymas pagal VDE 0701 arba šalyje galiojančius reglamentus.

⚠ PAVOJUS
Elektros smūgio pavojus dėl dalių, kuriose yra įtampa!
Mirtis dėl elektros smūgio

- ▶ Prieš pradėdami remontą, ne mažiau kaip prieš 60 sekundžių atjunkite prietaisus nuo elektros tiekimo.

⚠ PERSPĖJIMAS
Aštrios briaunos!
Galima įsijauti

- ▶ Mūvėkite apsaugines pirštines.

Reikalavimas.

- ✔ Prietaisas turi būti atjungtas nuo maitinimo šaltinio.
- ✔ Durelės turi būti atidarytos.

4.14.1 LED apšvietimo lempučių išėmimas

1. Pasinaudokite specialiu įrankiu ir išimkite LED apšvietimo lempučių (1).

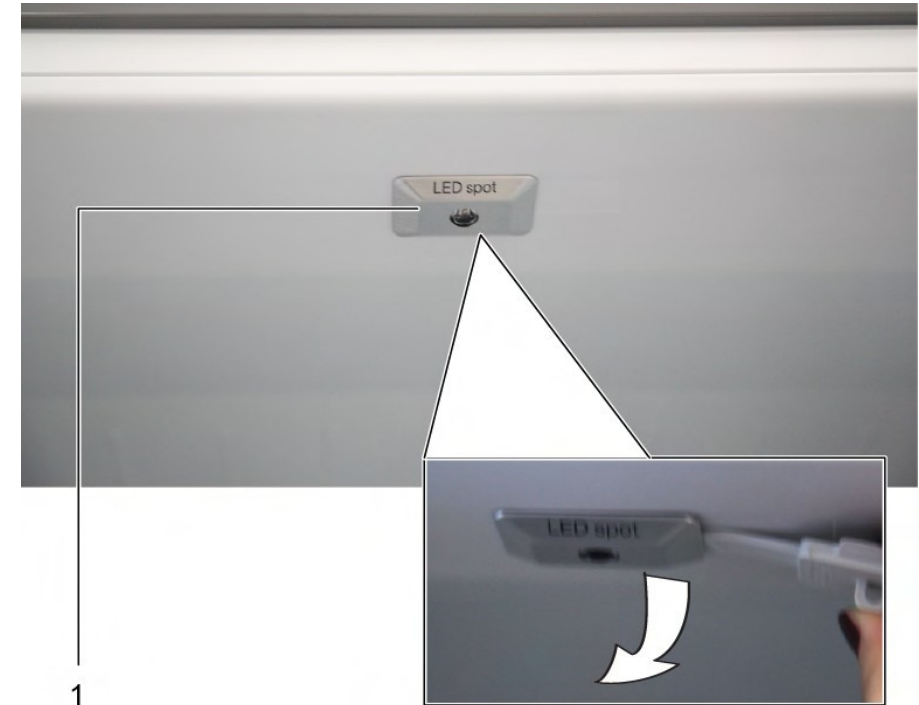

2. Atjunkite elektros LED apšvietimo lempučių jungtis.
- ➡ LED apšvietimo lempučių išimta.

4.14.2 LED apšvietimo lempučių montavimas

- ▶ Uždėkite atvirkščiai eilės tvarka.

4.15 Viršutinės LED keitimas

Specialūs įrankiai.

- Atsuktuvas su įpjovomis
- Mentė 2,4 mm x 0,4 mm x 60 mm, rinkinyje [00341820]



Jūsų prietaise įrengta techninės priežiūros nereikalaujanti LED lemputė. Šią lemputę gali taisyti tik klientų aptarnavimo tarnybos specialistai arba įgalioti technikai!



⚠ PAVOJUS

Elektros smūgio pavojus dėl dalių, kuriose yra įtampa!

Pavojus gyvybei dėl elektros smūgio netinkamo remonto atveju

- ▶ Elektrinės dalis remontuoti turi kvalifikuoti elektrikai.
- ▶ Po remonto pasirūpinkite, kad būtų atliktas saugos bandymas pagal VDE 0701 arba šalyje galiojančius reglamentus.



⚠ PAVOJUS

Elektros smūgio pavojus dėl dalių, kuriose yra įtampa!

Mirtis dėl elektros smūgio

- ▶ Prieš pradėdami remontą, ne mažiau kaip prieš 60 sekundžių atjunkite prietaisus nuo elektros tiekimo.



⚠ PERSPĖJIMAS

Aštrios briaunos!

Galima įsipjauti

- ▶ Mūvėkite apsaugines pirštines.

Reikalavimas.

- ✔ Prietaisas turi būti atjungtas nuo maitinimo šaltinio.
- ✔ Durelės turi būti atidarytos.
- ✔ Viršutiniai vidiniai tvirtinimo elementai turi būti nuimti.

4.15.1 LED lemputės išėmimas

1. Perkelkite LED lemputę į kairę.

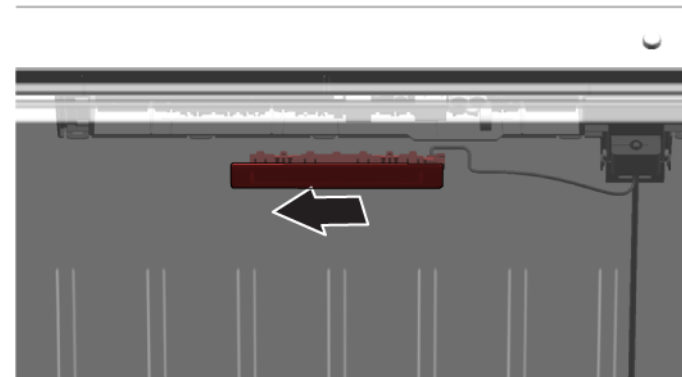

- ➡ LED elektros jungtis turi būti atjungta.

2. Atleiskite LED lemputės kabliukus.

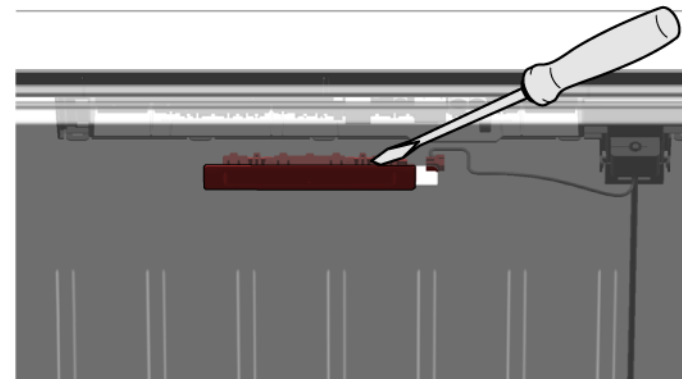

3. Išimkite LED lempuotę, perkeldami ją į priekį.

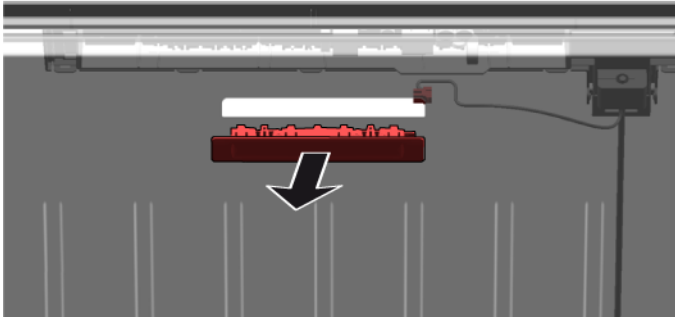

- ➔ LED lempuotė išimta.

4.15.2 Viršutinės LED lempuotės montavimas

- ▶ Uždėkite atvirkščia eilės tvarka.

4.16 Šoninės pailgos LED lemputės keitimas

Specialūs įrankiai.

Siurbtukas Ø50 mm [00342224]

 Jūsų prietaise įrengta techninės priežiūros nereikalaujanti LED lemputė. Šią lemputę gali taisyti tik klientų aptarnavimo tarnybos specialistai arba įgalioti technikai!

 **PAVOJUS**
Elektros smūgio pavojus dėl dalių, kuriose yra įtampa!
Pavojus gyvybei dėl elektros smūgio netinkamo remonto atveju

- ▶ Elektrinės dalis remontuoti turi kvalifikuoti elektrikai.
- ▶ Po remonto pasirūpinkite, kad būtų atliktas saugos bandymas pagal VDE 0701 arba šalyje galiojančius reglamentus.

 **PAVOJUS**
Elektros smūgio pavojus dėl dalių, kuriose yra įtampa!
Mirtis dėl elektros smūgio

- ▶ Prieš pradėdami remontą, ne mažiau kaip prieš 60 sekundžių atjunkite prietaisus nuo elektros tiekimo.

 **PERSPĖJIMAS**
Aštrios briaunos!
Galima įsijauti

- ▶ Mūvėkite apsaugines pirštines.

Reikalavimas.

- ✓ Prietaisas turi būti atjungtas nuo maitinimo šaltinio.
- ✓ Durelės turi būti atidarytos.
- ✓ Šaldytuvo skyriaus lentynos išimtos.

4.16.1 Šoninės pailgos LED lemputės išėmimas

1. Prilipdykite siurbtuką prie viršutinės pailgos LED šoninės lemputės viršutinio trečdaliao.



2. Patraukite siurbtuką kartu su priekine pailga LED šonine lempute vienu sukamuju judesiu.

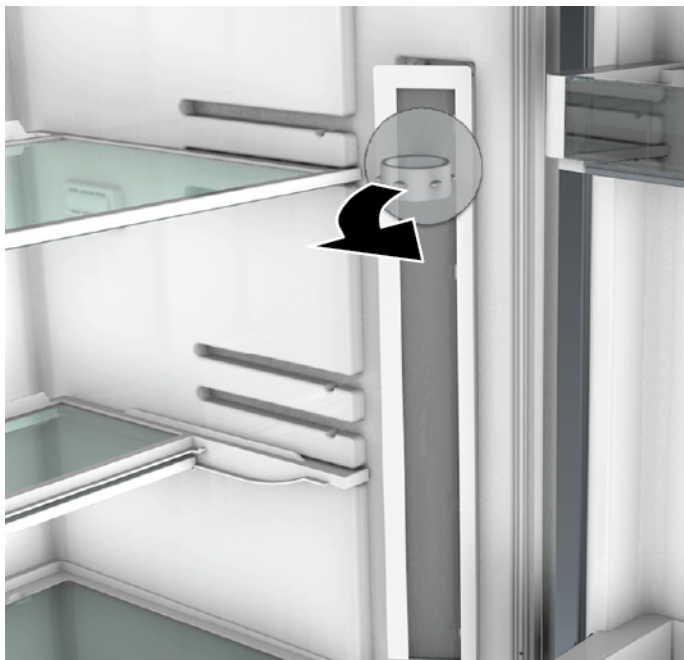

3. Atjunkite šoninės pailgos LED lemputės elektros jungtį.
 Šoninės pailgos LED lemputės elektros jungtis.

4.16.2 Šoninės pailgos LED lemputės montavimas

1. Prijunkite šoninės pailgos LED lemputės elektros jungtį.
 2. Pritvirtinkite šoninę pailgą LED lemputę į jai skirtą vietą skyrelio sienelėje (užfiksuokite kabliukus).
-  Šoninė pailga LED lemputė sumontuota.

4.17 LED apšvietimo lemputės keitimas

Specialūs įrankiai.

- Specialus įrankis [00342180]
- Atsuktuvas su įpjovomis Mentė 2,4 mm x 0,4 mm x 60 mm, rinkinyje [00341820]



Jūsų prietaise įrengta techninės priežiūros nereikalaujanti LED lemputė. Šią lemputę gali taisyti tik klientų aptarnavimo tarnybos specialistai arba įgalioti technikai!



⚠ PAVOJUS

Elektros smūgio pavojus dėl dalių, kuriose yra įtampa!

Pavojus gyvybei dėl elektros smūgio netinkamo remonto atveju

- ▶ Elektrinės dalis remontuoti turi kvalifikuoti elektrikai.
- ▶ Po remonto pasirūpinkite, kad būtų atliktas saugos bandymas pagal VDE 0701 arba šalyje galiojančius reglamentus.



⚠ PAVOJUS

Elektros smūgio pavojus dėl dalių, kuriose yra įtampa!

Mirtis dėl elektros smūgio

- ▶ Prieš pradėdami remontą, ne mažiau kaip prieš 60 sekundžių atjunkite prietaisus nuo elektros tiekimo.



⚠ PERSPĖJIMAS

Aštrios briaunos!

Galima įsijauti

- ▶ Mūvėkite apsaugines pirštines.

Reikalavimas.

- ✔ Prietaisas turi būti atjungtas nuo maitinimo šaltinio.
- ✔ Durelės turi būti atidarytos.
- ✔ Šaldytuvo skyriaus lentynos išimtos.

4.17.1 LED apšvietimo lemputės išėmimas

1. Atleiskite LED apšvietimo lemputės dangtelį.

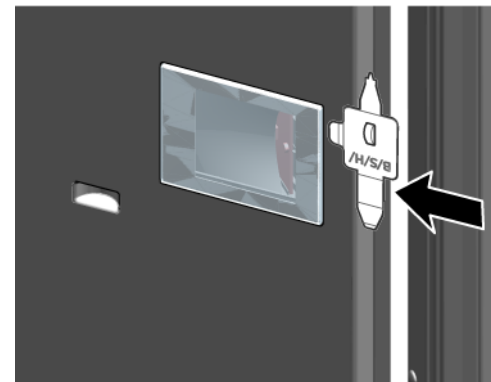

2. Patraukite LED apšvietimo lemputės dangtelį į vidų ir tuo pat metu paspauskite į priekį.

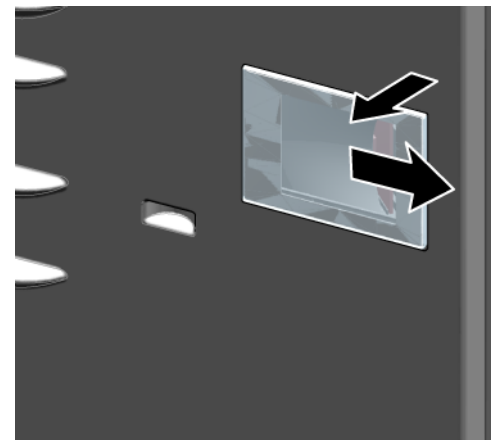

3. Atkabinkite LED apšvietimo lemputės modulį.

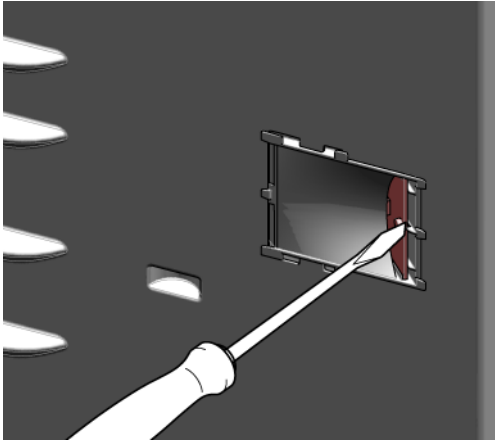

4. Atjunkite LED apšvietimo lemputės elektros jungtį.

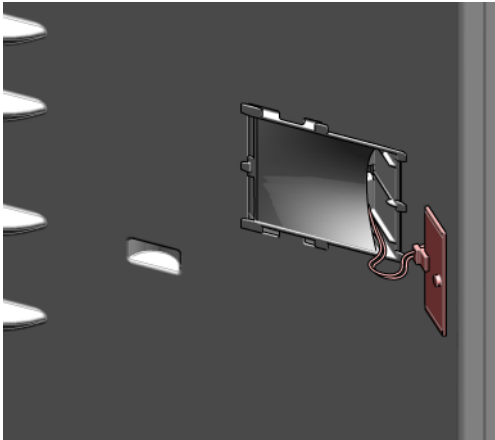

- ➔ LED apšvietimo lemputė išimta.

4.17.2 LED apšvietimo lemputės montavimas

- ▶ Uždėkite atvirkščia eilės tvarka.

Reparasjonstips - Kjøle-/frysekombinasjon

 Om dette dokumentet	438
1.1 Viktig informasjon	438
1.1.1 Formål.....	438
1.2 Forklaring av symboler.....	438
1.2.1 Farenivåer	438
1.2.2 Faresymboler.....	438
1.2.3 Advarslenes struktur	439
1.2.4 Generelle symboler	439
 Sikkerhet	440
2.1 Generelle sikkerhetsinstruksjoner	440
2.1.1 Alle husholdningsapparater	440
 Verktøy og hjelpemidler	441
 Reparasjon	442
4.1 Utskiftning av dørpakning.....	442
4.1.1 Demontering av dørpakning.....	442
4.1.2 Montering av dørpakning	442
4.2 Utskiftning av dørhåndtak.....	445
4.2.1 Demontering av dørhåndtak	445
4.2.2 Montering av dørhåndtak.....	445
4.3 Utskiftning av øvre dørhengsel	446
4.3.1 Demontering av øvre dørhengsel	446
4.3.2 Montering av øvre dørhengsel	447
4.4 Utskiftning av øvre dørhengsel (dør med display)	448
4.4.1 Demontering av øvre dørhengsel	448
4.4.2 Montering av øvre dørhengsel	449
4.5 Utskiftning av midtre dørhengsel	450
4.5.1 Demontering av midtre dørhengsel	450
4.5.2 Montering av midtre dørhengsel.....	450
4.6 Utskiftning av nedre dørhengsel	451
4.6.1 Demontering av nedre dørhengsel	451
4.6.2 Montering av nedre dørhengsel	451
4.7 Utskiftning av hylle.....	452
4.7.1 Demontering av hylle.....	452
4.7.2 Montering av hylle.....	452

4.8 Utskiftning av flaskehylle	453
4.8.1 Demontering av flaskehylle	453
4.8.2 Montering av flaskehylle.....	453
4.9 Utskiftning av dørrack.....	454
4.9.1 Demontering av dørrack.....	454
4.9.2 Montering av dørrack	454
4.10 Utskiftning av justerbar dørrack.....	455
4.10.1 Demontering av justerbar dørrack.....	455
4.10.2 Montering av justerbar dørrack	455
4.11 Utskiftning av beholder for frysevarer	456
4.11.1 Demontering av beholder for frysevarer	456
4.11.2 Montering av beholder for frysevarer	456
4.12 Utskiftning av beholder	457
4.12.1 Demontering av beholder	457
4.12.2 Montering av beholder	457
4.13 Utskiftning av uttrekkbar beholder	458
4.13.1 Demontering av uttrekkbar beholder	458
4.13.2 Montering av uttrekkbar beholder	458
4.14 Utskiftning av LED-spotlight.....	459
4.14.1 Demontering av LED-spotlight.....	459
4.14.2 Montering av LED-spotlight	459
4.15 Utskiftning av øverste LED-lampe	460
4.15.1 Demontering av LED-lampe	460
4.15.2 Montering av øverste LED-lampe	461
4.16 Utskiftning av LED-lampe i sidelist	462
4.16.1 Demontering av LED-lampe i sidelist	462
4.16.2 Montering av LED-lampe i sidelist.....	463
4.17 Utskiftning av LED-spotlight.....	464
4.17.1 Demontering av LED-spotlight.....	464
4.17.2 Montering av LED-spotlight.....	465

i Om dette dokumentet

1.1 Viktig informasjon

1.1.1 Formål

Disse tipsene om reparasjon skal hjelpe kunden til selv å kunne reparere apparater i samsvar med gjeldende regulering av øko-design (med gyldighet 03/2021).





De inneholder informasjon om hvordan definerte reservedeler skiftes, inklusive advarsler og risikoer.

Kontakt vår kundeservice dersom du har spørsmål. Vi påtar oss kun ansvar for skader dersom tipsene om reparasjon er korrekt fulgt.

1.2 Forklaring av symboler

1.2.1 Farenivåer

Advarslene som viser farenivå, består av et symbol og et signalord. Signalordet viser hvor alvorlig faren er.



Advarsel som viser farenivå	Betydning
 FARE	Dersom advarselen ignoreres, vil det føre til død eller alvorlige personskader.
 ADVARSEL	Dersom advarselen ignoreres, kan det føre til død eller alvorlige personskader.
 FORSIKTIG	Dersom advarselen ignoreres, kan det føre til mindre personskader.
 OBS!	Dersom advarselen ignoreres, kan det føre til materiell skade.

Tabell 1: Farenivåer



1.2.2 Faresymboler

Faresymboler er symbolske fremstillinger som gir en indikasjon av hvilken type fare det dreier seg om.

Følgende faresymboler brukes i dette dokumentet:

Faresymbol	Betydning
	Generell advarsel
	Fare for elektrisk støt
	Eksplisjonsfare
	Fare for å skjære seg
	Klemfare

i Om dette dokumentet

Faresymbol	Betydning
	Fare på grunn av varme overflater
	Fare på grunn av sterkt magnetfelt
	Fare fra ikke-ioniserende stråling

Tabell 2: Faresymboler

1.2.3 Advarslenes struktur

Advarslene i dette dokumentet har standardisert utseende og standardisert struktur.



	<div style="background-color: red; color: white; padding: 2px; text-align: center;">FARE</div> <p>Faretype og kilde til fare! Mulige konsekvenser dersom fare/advarsel ignoreres.</p> <ul style="list-style-type: none"> ▶ Tiltak og forbud for å forebygge fare.
--	--





Eksemplet nedenfor viser en advarsel mot elektrisk støt på grunn av strømførende deler. Tiltaket for å unngå faren er angitt.

	<div style="background-color: red; color: white; padding: 2px; text-align: center;">FARE</div> <p>Fare for elektrisk støt på grunn av strømførende deler! Død på grunn av drepende elektrisk støt</p> <ul style="list-style-type: none"> ▶ Koble apparatene fra strømforsyningen i minst 60 sekunder før reparasjonene startes.
---	--

1.2.4 Generelle symboler

Følgende generelle symboler brukes i dette dokumentet:

Gen. symbol	Betydning
	Identifisering av et spesielt tips (tekst og/eller grafikk)
	Identifisering av et enkelt tips (kun tekst)
	Identifisering av en lenke til en opplæringsvideo

Gen. symbol	Betydning
	Identifisering av nødvendig verktøy
	Identifisering av nødvendige forutsetninger
	Identifisering av en betingelse (hvis ..., så ...)
	Identifisering av et resultat
[Start]	Identifisering av en tast eller knapp
[00123456]	Identifisering av et materialnummer
Status	Identifisering av vist tekst/vindu (i apparatets display)

Tabell 3: Generelle symboler

2.1 Generelle sikkerhetsinstruksjoner

2.1.1 Alle husholdningsapparater

Fare for elektrisk støt på grunn av strømførende deler!

- Feil ved reparasjoner hvor elektriske komponenter er involvert, kan føre til elektrisk støt!
- Koble apparatet fra strømmettet i minst 60 sekunder før arbeidet startes.
- Etter reparasjonen må du sørge for at det utføres en sikkerhetstest iht. VDE 0701 eller gjeldende forskrifter i det respektive land.

Fare for personskade på grunn av skarpe kanter!

- Bruk vernehansker.

Fare for å knuse legemsdeler under reparasjoner, vedlikehold, feilsøking og service på grunn av tunge og bevegelige komponenter

- Bruk vernesko.
- Sikre tunge komponenter for å hindre at de faller ned.
- Ikke stikk kroppsdelene inn i bevegelige komponenter.





Fare for apparatets sikkerhet/funksjon!

- Bruk kun originale reservedeler.

Fare for skade på deler som er følsomme overfor elektrostatisk utlading (ESD)!

- Ikke berør modulene, inklusive tilkoblinger og ledere.

Verktøy og hjelpemidler

Betegnelse	Detaljer	Bilder
Beskyttelsesklut [00342013]	60 cm x 50 cm	
Flat skrutrekker	Blad 2,4 mm x 0,4 mm x 60 mm, i sett [00341820]	
Spesialverktøy [00342180]		
Sugekopp [00342224]	Ø50 mm	
Torx-bits TX20 [00340865]	6,3 mm (1/4")	
Flat skrutrekker	Blad 10 mm x 1,6 mm x 200 mm	

4.1 Utskiftning av dørpakning

Forutsetning:

- ✔ Døren er åpen.

4.1.1 Demontering av dørpakning

1. Løsne dørpakningen fra sporet i høyre og venstre hjørne.

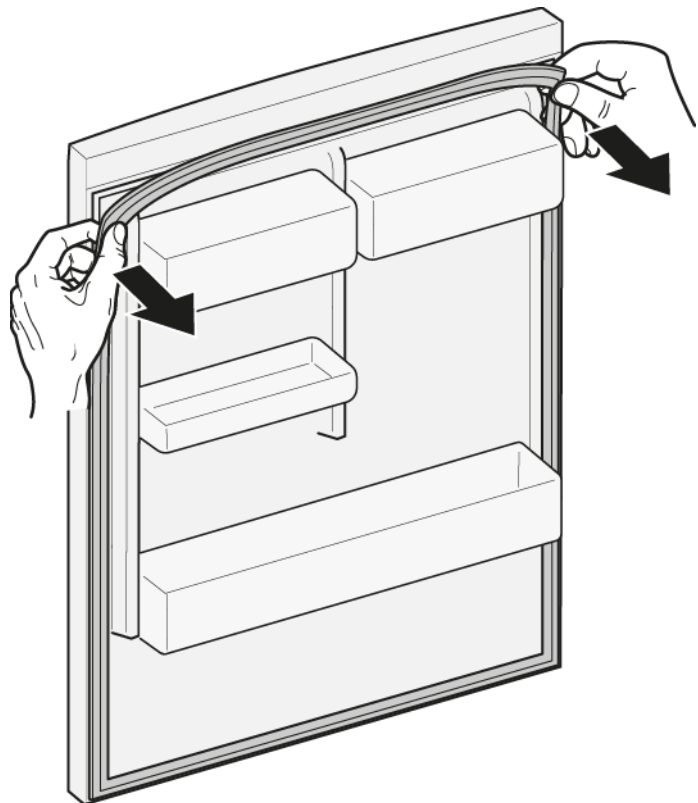

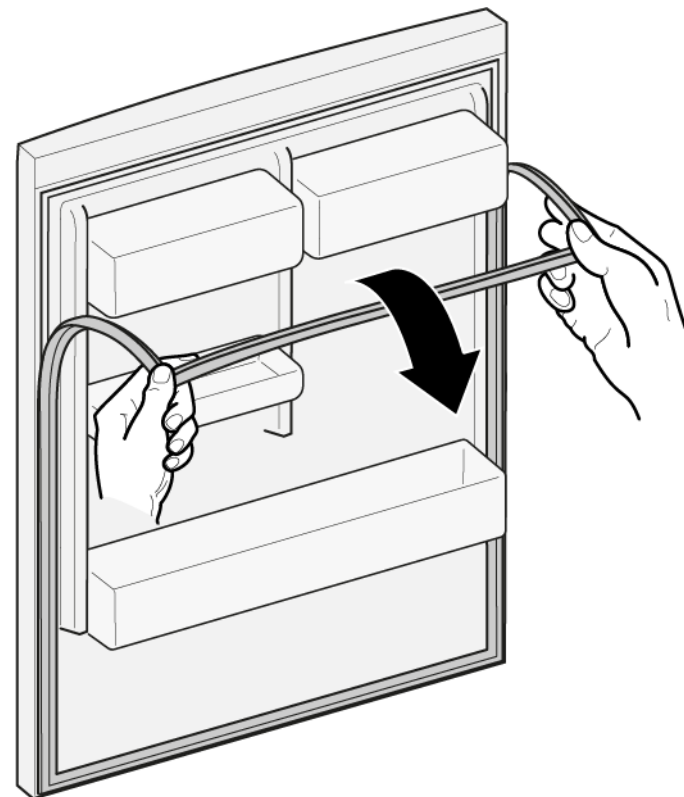

2. Trekk pakningen ut av sporet.



- ➡ Dørpakningen er demontert.

4.1.2 Montering av dørpakning

	Tykkelsen på den nye dørpakningen kan avvike litt fra tykkelsen på den gamle dørpakningen. Det har ingen innvirkning på lukkeatferd og langvarig funksjon.
	Hvis apparatet har justerbare hengsler eller hengslefester, kan du optimalisere lukkeatferden etterpå.
	Små sidehull i dørpakningen har en funksjon (nødvendige for ventilasjonen). Det dreier seg ikke om produksjonsfeil.

Reparasjon

1. Kontroller at sporet for pakningen ikke har skader.

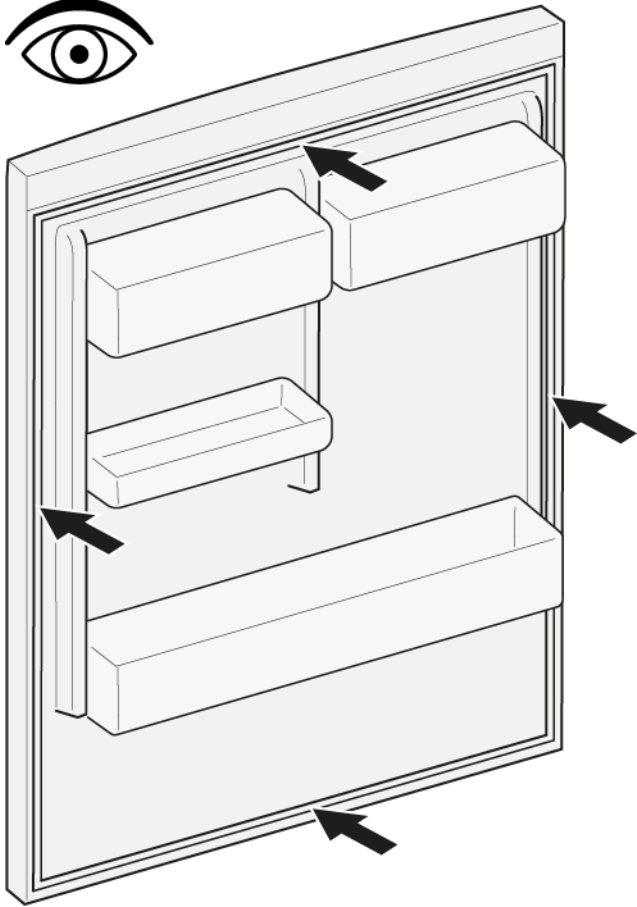

2.  Hvis sporet for pakningen er skadet:
 - Kontakt kundeservice.

3.  Litt deformasjon av dørpakningen er normalt og har ingen innvirkning på funksjonen. Det anbefales å rette ut dørpakningen før den settes inn i apparatet.

Varm opp dørpakningen med en føn eller varmt vann og form den på nytt med hendene.

4. Skyv pakningens hjørner øverst og nederst inn i sporet.

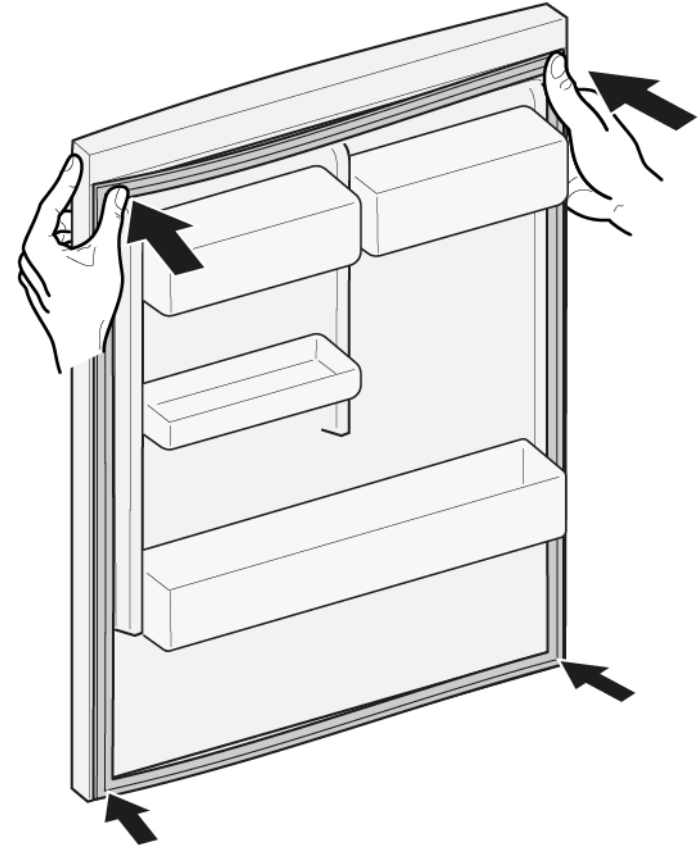

Reparasjon

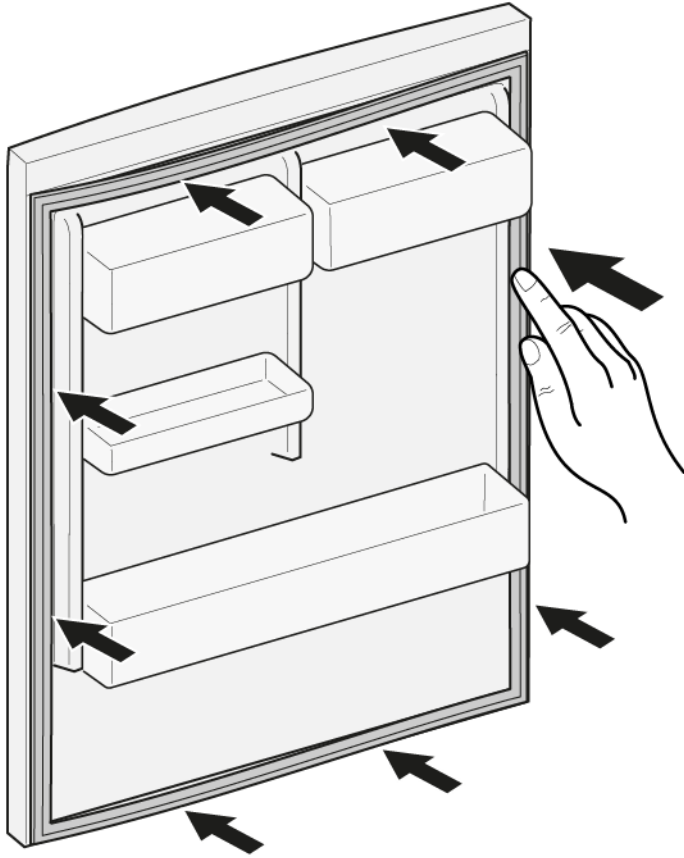

5. Trykk hele pakningen inn i sporet trinn for trinn.





 Dørpakningen er montert.

4.2 Utskiftning av dørhåndtak

Spesielle hjelpemidler:

-  Torx-bits TX20 6,3 mm (1/4") [00340865]
-  Flat skrutrekker Blad 10 mm x 1,6 mm x 200 mm

Forutsetning:

-  Apparatet kobles fra strømforsyningen.
-  Døren er åpen.

4.2.1 Demontering av dørhåndtak

- ▶ 1. Fjern to skruhetter (1).
- ▶ 2. Skru ut to skruer (2).
- ▶ 3. Demonter dørhåndtaket (3).

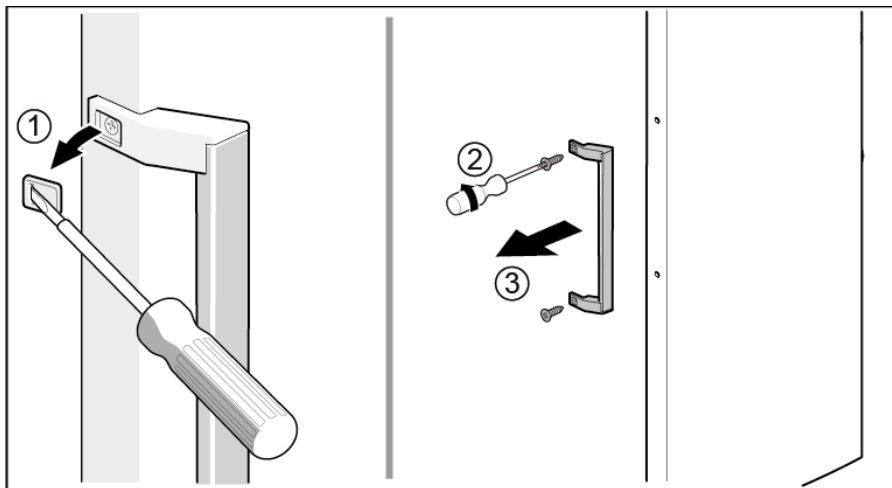

 Dørhåndtaket er demontert.



Dørhåndtaket for den andre døren kan demonteres på samme måte.

4.2.2 Montering av dørhåndtak

- ▶ Monteres i motsatt rekkefølge.

4.3 Utskiftning av øvre dørhengsel

Spesielle hjelpemidler:

Torx-bits TX20

6,3 mm (1/4")

[00340865]

	ADVARSEL Tunge, klumpete apparater! Rygg- og muskelskader ▶ Arbeidet med å demontere apparatets dør skal bare utføres av opplærte spesialister. ▶ Det kreves to personer for å flytte på apparatet. ▶ Bruk kun egnet verktøy og utstyr.
	FORSIKTIG Skarpe kanter! Kuttskader ▶ Bruk vernehansker.
	ADVARSEL Tiltede apparater kan skli ut! Beinbrudd/klemskader ▶ Sikre apparatene mot å skli ut.
	FORSIKTIG Fare for at deler kan falle ned på grunn av løsnede skruer! Personskade på grunn av fallende deler. ▶ Sikre komponenten så den ikke kan falle ned.
	OBS! Fare for at deler kan falle ned på grunn av løsnede skruer! Skade på andre deler på apparatet eller i kundens hjem, f.eks. gulv. ▶ Sikre komponenten så den ikke kan falle ned.

Forutsetning:

- ✓ Apparatet kobles fra strømforsyningen.
- ✓ Apparatets innvendige beslag er demontert.

4.3.1 Demontering av øvre dørhengsel

1. Plasser apparatet på baksiden.

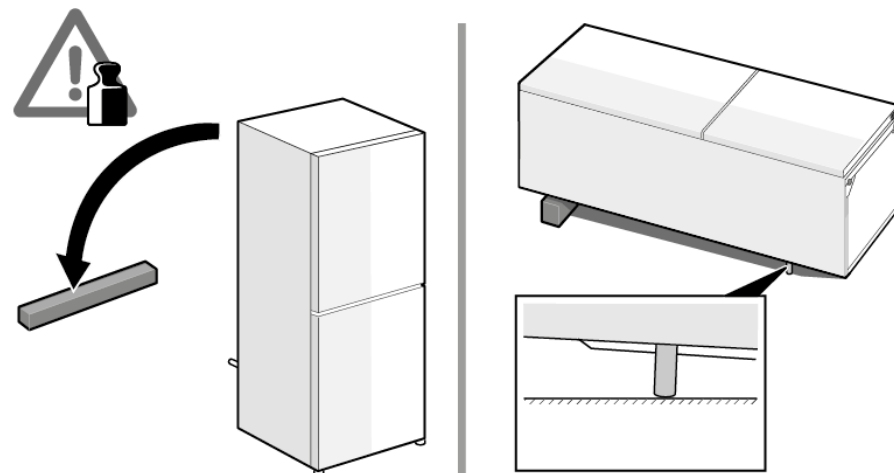

Reparasjon

2. 1. Trykk inn det øvre hengseldekslet på begge sider (1).
2. Beveg det øvre hengseldekslet ut (2).
3. Drei hengseldekslet (3).
4. Ta av det øvre hengseldekslet (4).
5. Skru ut to skruer (5).
6. Demonter øvre hengsel (6)/

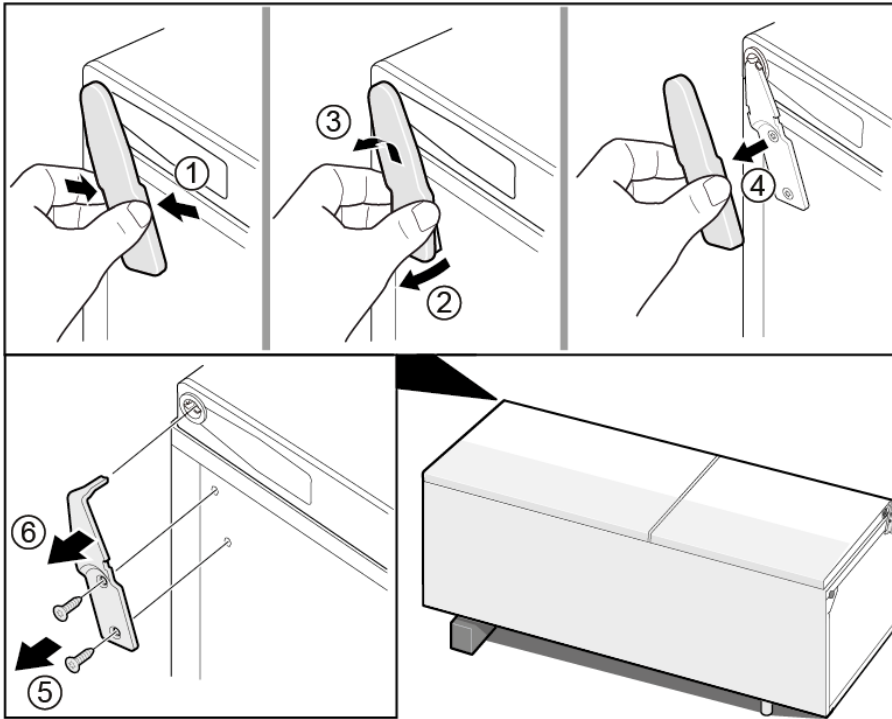

 Øvre hengsel er demontert.

4.3.2 Montering av øvre dørhengsel

- ▶ Monteres i motsatt rekkefølge.

4.4 Utskiftning av øvre dørhengsel (dør med display)

Spesielle hjelpemidler:

Torx-bits TX20 6,3 mm (1/4") [00340865]

	⚠ ADVARSEL
	<p>Tunge, klumpete apparater! Rygg- og muskelskader</p> <ul style="list-style-type: none"> ▶ Arbeidet med å demontere apparatets dør skal bare utføres av opplærte spesialister. ▶ Det kreves to personer for å flytte på apparatet. ▶ Bruk kun egnet verktøy og utstyr.

	⚠ FORSIKTIG
	<p>Skarpe kanter! Kuttskader</p> <ul style="list-style-type: none"> ▶ Bruk vernehansker.

	⚠ ADVARSEL
	<p>Tiltede apparater kan skli ut! Beinbrudd/klemskader</p> <ul style="list-style-type: none"> ▶ Sikre apparatene mot å skli ut.

	⚠ FORSIKTIG
	<p>Fare for at deler kan falle ned på grunn av løsnede skruer! Personskade på grunn av fallende deler.</p> <ul style="list-style-type: none"> ▶ Sikre komponenten så den ikke kan falle ned.

	OBS!
	<p>Fare for at deler kan falle ned på grunn av løsnede skruer! Skade på andre deler på apparatet eller i kundens hjem, f.eks. gulv.</p> <ul style="list-style-type: none"> ▶ Sikre komponenten så den ikke kan falle ned.

	⚠ FARE
	<p>Fare for elektrisk støt på grunn av strømførende deler! Livsfare på grunn av elektrisk støt ved feil reparasjon</p> <ul style="list-style-type: none"> ▶ Elektriske deler skal repareres av kvalifiserte elektrikere. ▶ Etter reparasjonen må du sørge for at det utføres en sikkerhets-test iht. VDE 0701 eller gjeldende forskrifter i det respektive land.

	⚠ FARE
	<p>Fare for elektrisk støt på grunn av strømførende deler! Død på grunn av drepende elektrisk støt</p> <ul style="list-style-type: none"> ▶ Koble apparatene fra strømforsyningen i minst 60 sekunder før reparasjonene startes.

Forutsetning:

- ✓ Apparatet kobles fra strømforsyningen.
- ✓ Apparatets innvendige beslag er demontert.

4.4.1 Demontering av øvre dørhengsel

1. Plasser apparatet på baksiden.

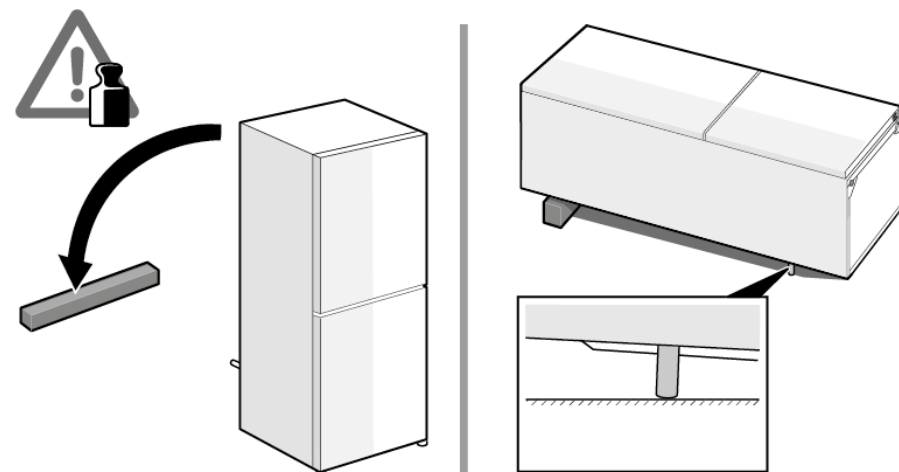

Reparasjon

2. 1. Ta av det øvre hengseldekslet (1).
2. Ta av kabelboksdekslet (2).
3. Koble fra den elektriske tilkoblingen (3).
4. Skru ut skruen for jordkoblingen (4).
5. Fjern kabelbeskyttelsen (5).
6. Skru ut skruen (6)

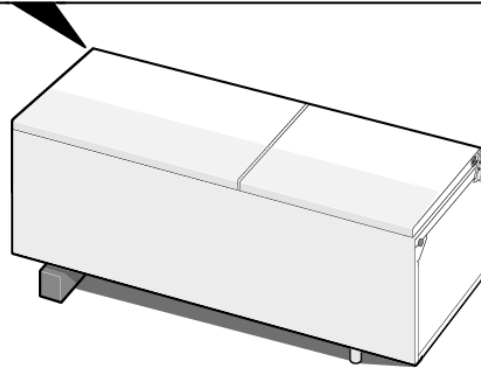
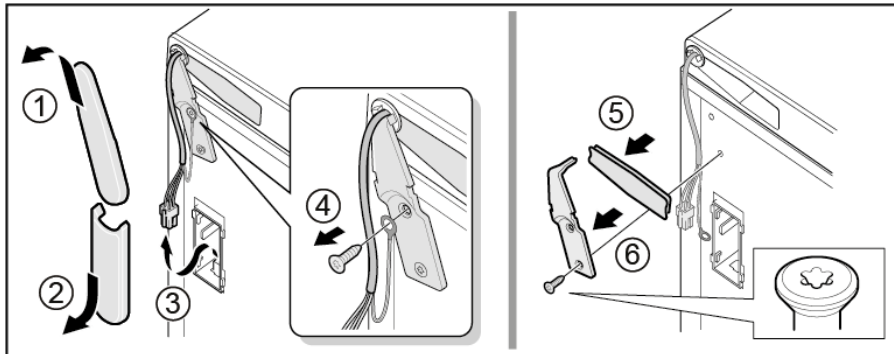

 Øvre hengsel er demontert.

4.4.2 Montering av øvre dørhengsel

- ▶ Monteres i motsatt rekkefølge.

4.5 Utskiftning av midtre dørhengsel

Spesielle hjelpemidler:

Torx-bits TX20 6,3 mm (1/4") [00340865]

	ADVARSEL Tunge, klumpete apparater! Rygg- og muskelskader ▶ Arbeidet med å demontere apparatets dør skal bare utføres av opplærte spesialister. ▶ Det kreves to personer for å flytte på apparatet. ▶ Bruk kun egnet verktøy og utstyr.
--	--

	FORSIKTIG Skarpe kanter! Kuttskader ▶ Bruk vernehansker.
--	---

	ADVARSEL Tiltede apparater kan skli ut! Beinbrudd/klemskader ▶ Sikre apparatene mot å skli ut.
--	---

	FORSIKTIG Fare for at deler kan falle ned på grunn av løsnede skruer! Personskade på grunn av fallende deler. ▶ Sikre komponenten så den ikke kan falle ned.
---	---

	OBS! Fare for at deler kan falle ned på grunn av løsnede skruer! Skade på andre deler på apparatet eller i kundens hjem, f.eks. gulv. ▶ Sikre komponenten så den ikke kan falle ned.
--	---

Forutsetning:

- ✔ Apparatet kobles fra strømforsyningen.
- ✔ Apparatets innvendige beslag er demontert.
- ✔ Øvre dørhengsel er demontert.

4.5.1 Demontering av midtre dørhengsel

- ▶ 1. Demonter døren til frysen (1).
- ▶ 2. Skru ut to skruer (2).
- ▶ 3. Demonter midtre hengsel (3).

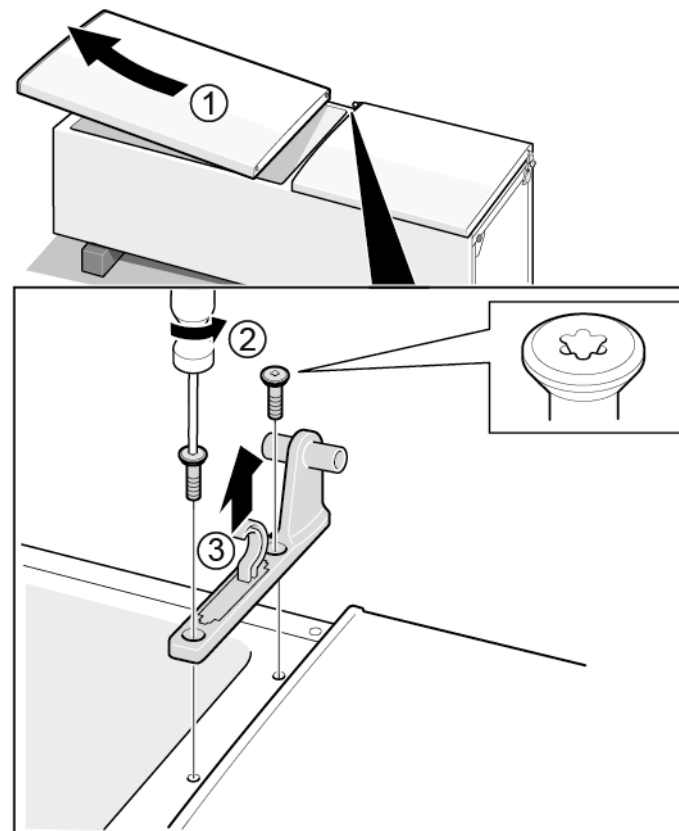

➡ Midtre hengsel er demontert.

4.5.2 Montering av midtre dørhengsel

- ▶ Monteres i motsatt rekkefølge.

4.6 Utskiftning av nedre dørhengsel

Spesielle hjelpemidler:

Torx-bits TX20 6,3 mm (1/4") [00340865]

	ADVARSEL
Tunge, klumpete apparater!	
Rygg- og muskelskader	
<ul style="list-style-type: none"> ▶ Arbeidet med å demontere apparatets dør skal bare utføres av opplærte spesialister. ▶ Det kreves to personer for å flytte på apparatet. ▶ Bruk kun egnet verktøy og utstyr. 	

	FORSIKTIG
Skarpe kanter!	
Kuttskader	
<ul style="list-style-type: none"> ▶ Bruk vernehansker. 	

	ADVARSEL
Tiltede apparater kan skli ut!	
Beinbrudd/klemskader	
<ul style="list-style-type: none"> ▶ Sikre apparatene mot å skli ut. 	

	FORSIKTIG
Fare for at deler kan falle ned på grunn av løsnede skruer!	
Personskade på grunn av fallende deler.	
<ul style="list-style-type: none"> ▶ Sikre komponenten så den ikke kan falle ned. 	

	OBS!
Fare for at deler kan falle ned på grunn av løsnede skruer!	
Skade på andre deler på apparatet eller i kundens hjem, f.eks. gulv.	
<ul style="list-style-type: none"> ▶ Sikre komponenten så den ikke kan falle ned. 	

Forutsetning:

- ✔ Apparatet kobles fra strømforsyningen.
- ✔ Apparatets innvendige beslag er demontert.
- ✔ Øvre hengsel er demontert.
- ✔ Midtre hengsel er demontert.

4.6.1 Demontering av nedre dørhengsel

- ▶ 1. Demonter døren til frysen (1).
- ▶ 2. Skru ut skruen (2).
- ▶ 3. Drei den nedre hengselen ut (3).
- ▶ 4. Demonter nedre hengsel (4).

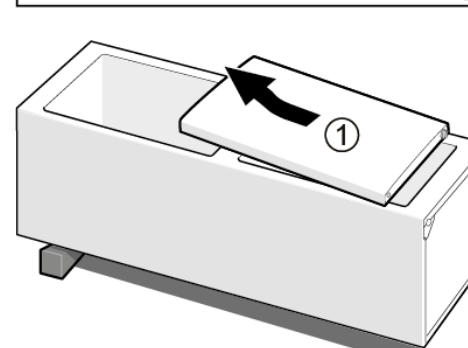
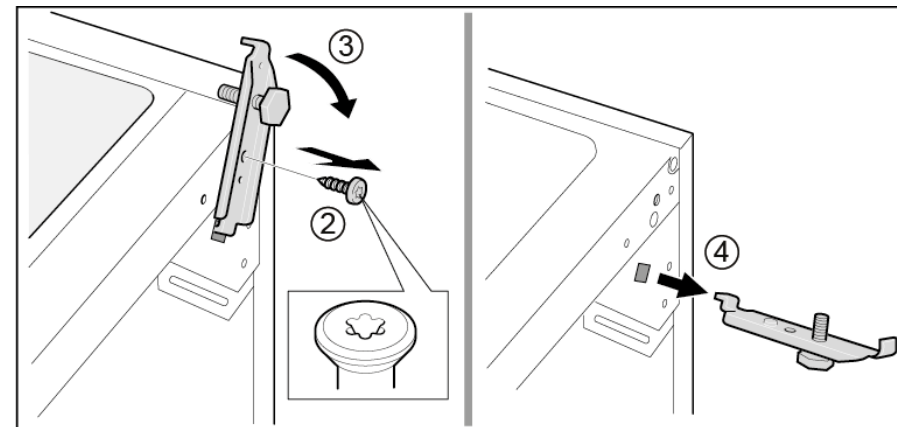

➡ Nedre dørhengsel er demontert.

4.6.2 Montering av nedre dørhengsel

- ▶ Monteres i motsatt rekkefølge.

4.7 Utskiftning av hylle

Forutsetning:

- ✔ Døren er åpen.

4.7.1 Demontering av hylle

- ▶ Trekk ut hyllen.

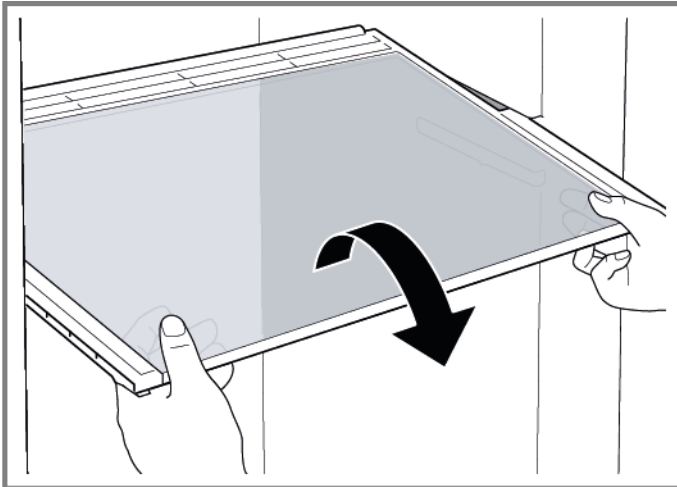

- ➡ Hyllen er demontert.

4.7.2 Montering av hylle

- ▶ Monteres i motsatt rekkefølge.

4.8 Utskiftning av flaskehylle

Forutsetning:

- ✔ Døren er åpen.

4.8.1 Demontering av flaskehylle

- ▶ Trekk ut flaskehyllen.

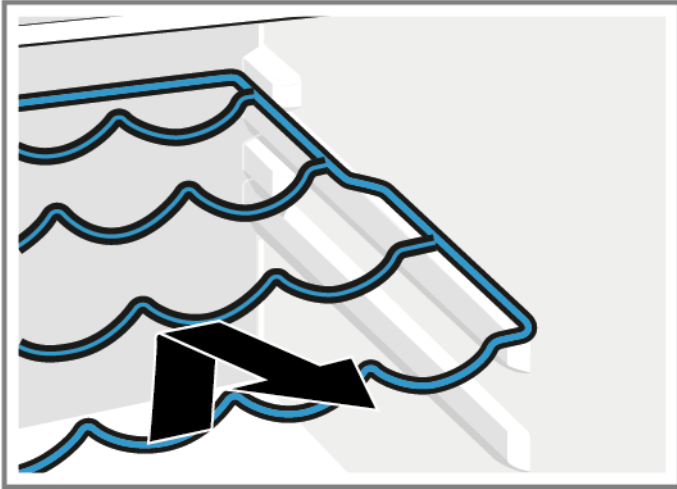

- ➡ Flaskehyllen er demontert.

4.8.2 Montering av flaskehylle

- ▶ Monteres i motsatt rekkefølge.

4.9 Utskiftning av dørrack

Forutsetning:

- ✔ Døren er åpen.

4.9.1 Demontering av dørrack

- ▶ Løft dørracken opp.

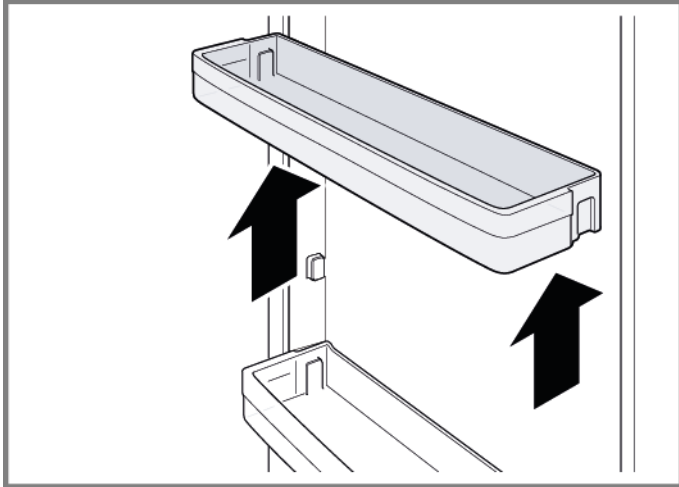

➡ Dørracken er demontert.

4.9.2 Montering av dørrack

- ▶ Monteres i motsatt rekkefølge.

4.10 Utskiftning av justerbar dørrack

Forutsetning:

- ✔ Døren er åpen.

4.10.1 Demontering av justerbar dørrack

- ▶ Beveg den høydejusterbare dørracken opp til dørracken løsner fra holderen.

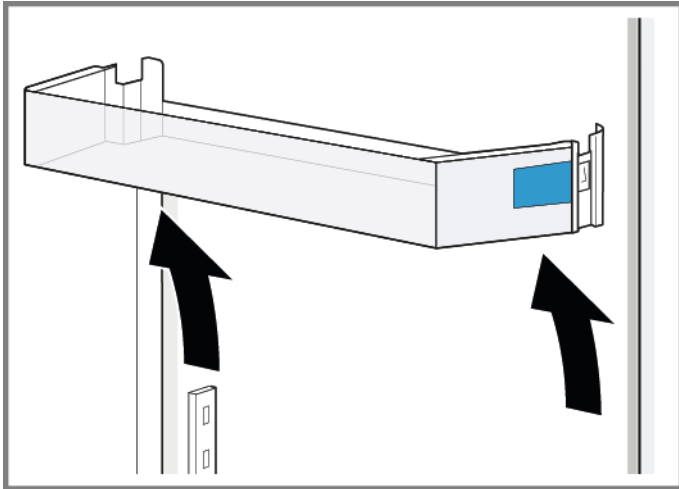

➡ Den justerbare dørracken er demontert.

4.10.2 Montering av justerbar dørrack

- ▶ Monteres i motsatt rekkefølge.

4.11 Utskiftning av beholder for frysevarer

Forutsetning:

- ✔ Døren er åpen.

4.11.1 Demontering av beholder for frysevarer

- ▶ 1. Trekk beholderen for frysevarer helt ut (1).
- ▶ 2. Ta ut matbeholderen (2).

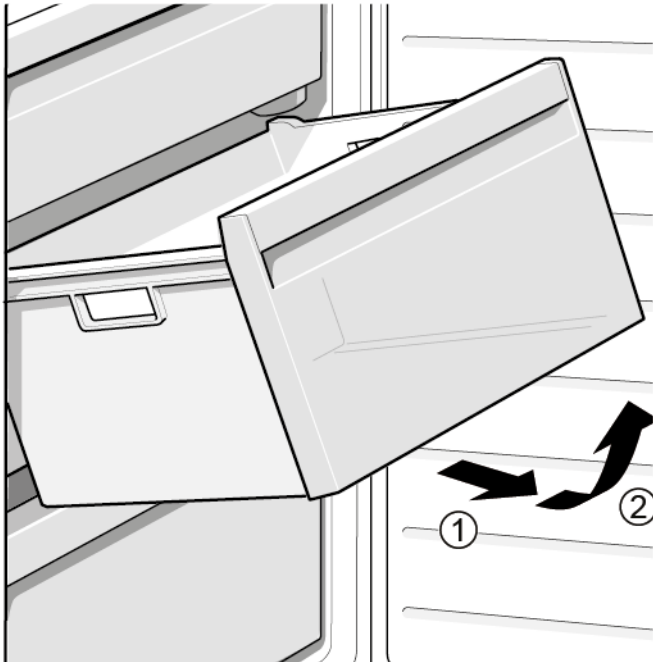

- ➡ Beholderen for frysevarer er demontert.

4.11.2 Montering av beholder for frysevarer

- ▶ Monteres i motsatt rekkefølge.

4.12 Utskiftning av beholder

Forutsetning:

- ✔ Døren er åpen.

4.12.1 Demontering av beholder

- ▶ 1. Beveg den nedre beholderen i kjøleskapet ut (1).
- ▶ 2. Beveg den øvre beholderen i kjøleskapet ut (2).

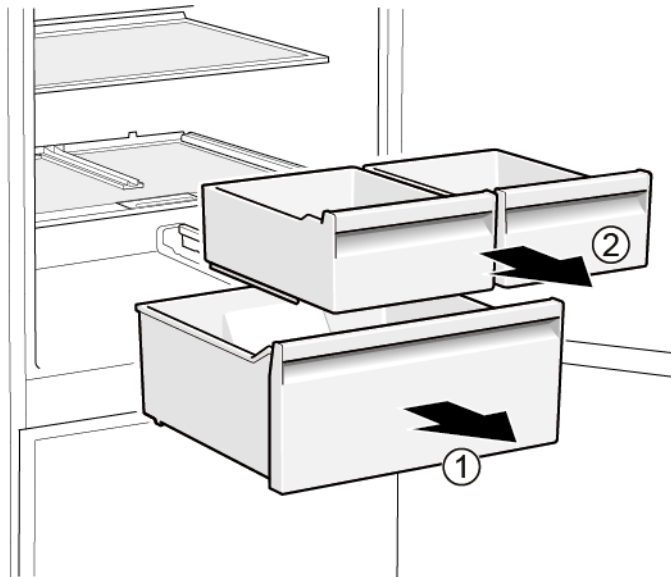

- ➡ Beholderne er demontert.

4.12.2 Montering av beholder

- ▶ Monteres i motsatt rekkefølge.

4.13 Utskiftning av uttrekkbar beholder

Forutsetning:

- ✔ Døren er åpen.

4.13.1 Demontering av uttrekkbar beholder

- ▶ 1. Trekk den uttrekkbare beholderen helt ut (1).
- ▶ 2. Ta ut den uttrekkbare beholderen (2).

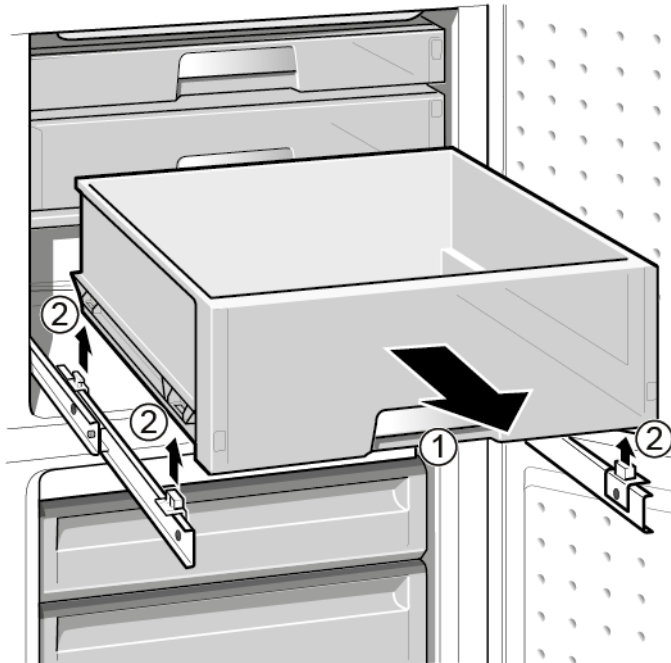

- ➡ Den uttrekkbare beholderen er demontert.

4.13.2 Montering av uttrekkbar beholder

- ▶ Monteres i motsatt rekkefølge.

4.14 Utskiftning av LED-spotlight

Spesielle hjelpemidler:

Spesialverktøy [00342180]



Apparatet har en vedlikeholdsfri LED-lampe. Disse lampene skal kun repareres av kundeservice eller autoriserte teknikere!



FARE

Fare for elektrisk støt på grunn av strømførende deler!

Livsfare på grunn av elektrisk støt ved feil reparasjon

- ▶ Elektriske deler skal repareres av kvalifiserte elektrikere.
- ▶ Etter reparasjonen må du sørge for at det utføres en sikkerhets-test iht. VDE 0701 eller gjeldende forskrifter i det respektive land.



FARE

Fare for elektrisk støt på grunn av strømførende deler!

Død på grunn av drepende elektrisk støt

- ▶ Koble apparatene fra strømforsyningen i minst 60 sekunder før reparasjonene startes.



FORSIKTIG

Skarpe kanter!

Kuttskader

- ▶ Bruk vernehansker.

Forutsetning:

- ✓ Apparatet kobles fra strømforsyningen.
- ✓ Døren er åpen.

4.14.1 Demontering av LED-spotlight

1. Bruk spesialverktøy for å trekke ut LED-spotlight (1).

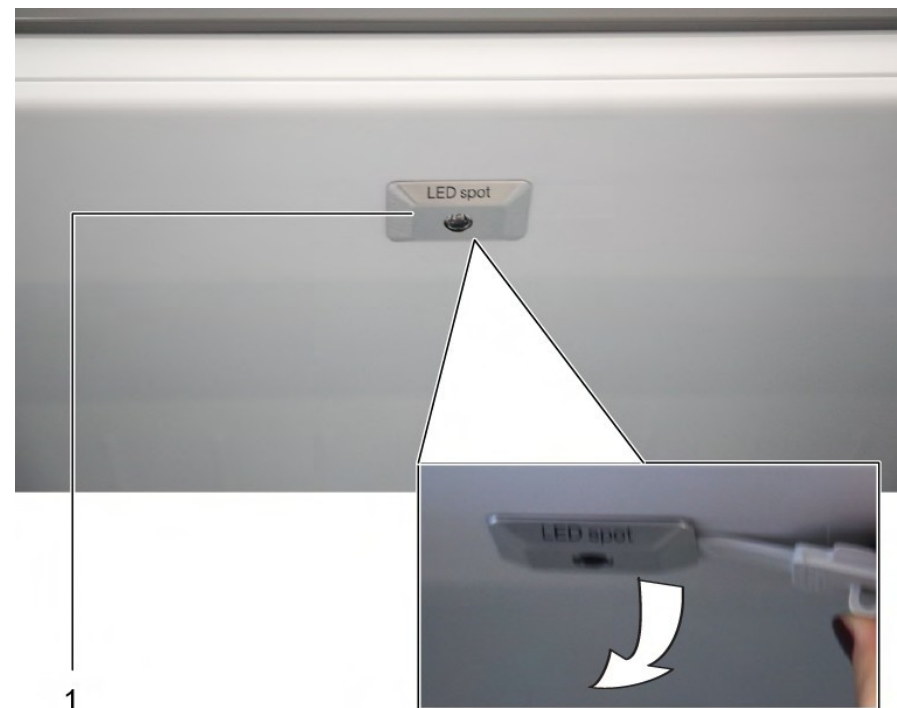

2. Koble fra de elektriske tilkoblingene for LED-spotlight.
➡ LED-spotlight er demontert.

4.14.2 Montering av LED-spotlight

- ▶ Monteres i motsatt rekkefølge.

4.15 Utskiftning av øverste LED-lampe

Spesielle hjelpemidler:

- Flat skrutrekker Blad 2,4 mm x 0,4 mm x 60 mm, i sett [00341820]

i Apparatet har en vedlikeholdsfri LED-lampe. Disse lampene skal kun repareres av kundeservice eller autoriserte teknikere!

! **FARE**
Fare for elektrisk støt på grunn av strømførende deler!
Livsfare på grunn av elektrisk støt ved feil reparasjon

- ▶ Elektriske deler skal repareres av kvalifiserte elektrikere.
- ▶ Etter reparasjonen må du sørge for at det utføres en sikkerhets-test iht. VDE 0701 eller gjeldende forskrifter i det respektive land.

! **FARE**
Fare for elektrisk støt på grunn av strømførende deler!
Død på grunn av drepende elektrisk støt

- ▶ Koble apparatene fra strømforsyningen i minst 60 sekunder før reparasjonene startes.

! **FORSIKTIG**
Skarpe kanter!
Kuttskader

- ▶ Bruk vernehansker.

Forutsetning:

- ✔ Apparatet kobles fra strømforsyningen.
- ✔ Døren er åpen.
- ✔ De øvre innvendige beslagene er demontert.

4.15.1 Demontering av LED-lampe

1. Beveg LED-lampen over til venstre side.



2. Løsne LED-lampens kroker.

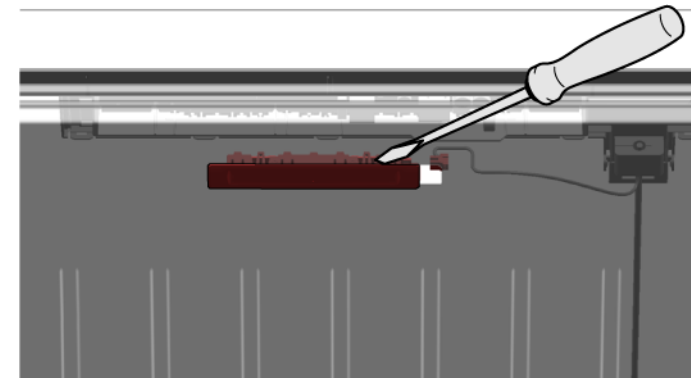

Reparasjon

3. Demonter LED-lampen ved å bevege den forover.

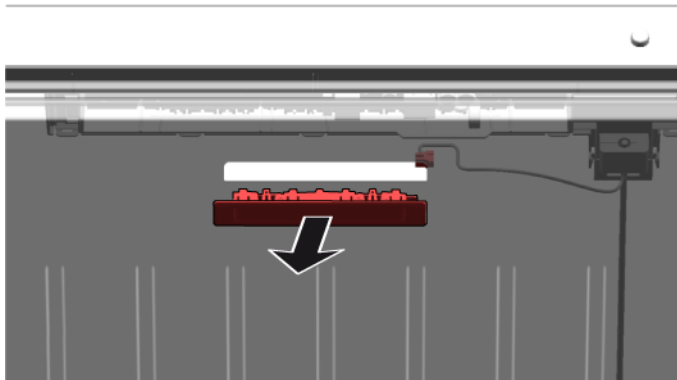

- LED-lampen er demontert.

4.15.2 Montering av øverste LED-lampe

- ▶ Monteres i motsatt rekkefølge.

4.16 Utskiftning av LED-lampe i sidelist

Spesielle hjelpemidler:

Sugekopp Ø50 mm [00342224]



Apparatet har en vedlikeholdsfri LED-lampe.
Disse lampene skal kun repareres av kundeservice eller autoriserte teknikere!



FARE

Fare for elektrisk støt på grunn av strømførende deler!

Livsfare på grunn av elektrisk støt ved feil reparasjon

- ▶ Elektriske deler skal repareres av kvalifiserte elektrikere.
- ▶ Etter reparasjonen må du sørge for at det utføres en sikkerhets-test iht. VDE 0701 eller gjeldende forskrifter i det respektive land.



FARE

Fare for elektrisk støt på grunn av strømførende deler!

Død på grunn av drepende elektrisk støt

- ▶ Koble apparatene fra strømforsyningen i minst 60 sekunder før reparasjonene startes.



FORSIKTIG

Skarpe kanter!

Kuttskader

- ▶ Bruk vernehansker.

Forutsetning:

- ✓ Apparatet kobles fra strømforsyningen.
- ✓ Døren er åpen.
- ✓ Hyllene i fryseren er tatt ut.

4.16.1 Demontering av LED-lampe i sidelist

1. Fest sugekoppen på øvre tredel av LED-lampen i sidelisten.



Reparasjon

2. Trekk sugekoppen forover med LED-lampen i sidelisten i en roterende bevegelse.

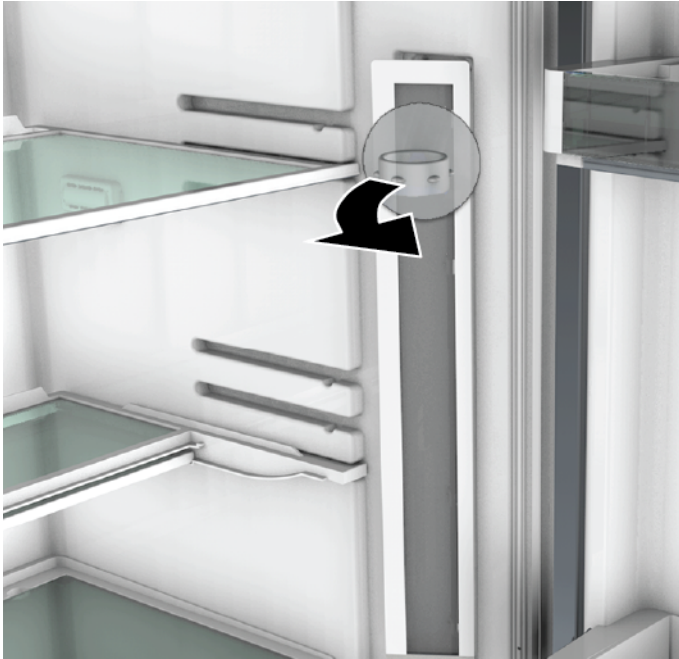

3. Koble fra den elektriske tilkoblingen for LED-lampen i sidelisten.
➡ LED-lampen i sidelisten er demontert.

4.16.2 Montering av LED-lampe i sidelist

1. Koble til den elektriske tilkoblingen for LED-lampen i sidelisten.
 2. Fest LED-lampen i sidelisten på rett sted på veggen i apparatrommet (krokene klikker på plass).
- ➡ LED-lampen i sidelisten er montert.

4.17 Utskiftning av LED-spotlight

Spesielle hjelpemidler:

- Spesialverktøy [00342180]
- Flat skrutrekker Blad 2,4 mm x 0,4 mm x 60 mm, i sett [00341820]

 Apparatet har en vedlikeholdsfri LED-lampe. Disse lampene skal kun repareres av kundeservice eller autoriserte teknikere!

 **FARE**
Fare for elektrisk støt på grunn av strømførende deler!
Livsfare på grunn av elektrisk støt ved feil reparasjon

- Elektriske deler skal repareres av kvalifiserte elektrikere.
- Etter reparasjonen må du sørge for at det utføres en sikkerhetstest iht. VDE 0701 eller gjeldende forskrifter i det respektive land.

 **FARE**
Fare for elektrisk støt på grunn av strømførende deler!
Død på grunn av drepende elektrisk støt

- Koble apparatene fra strømforsyningen i minst 60 sekunder før reparasjonene startes.

 **FORSIKTIG**
Skarpe kanter!
Kuttskader

- Bruk vernehansker.

Forutsetning:

- Apparatet kobles fra strømforsyningen.
- Døren er åpen.
- Hyllene i fryseren er tatt ut.

4.17.1 Demontering av LED-spotlight

- Løsne LED-spotlightdekslet.

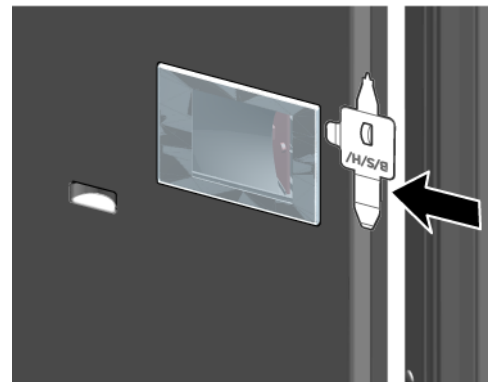

- Trekk LED-spotlightdekslet innover og skyv det samtidig forover.

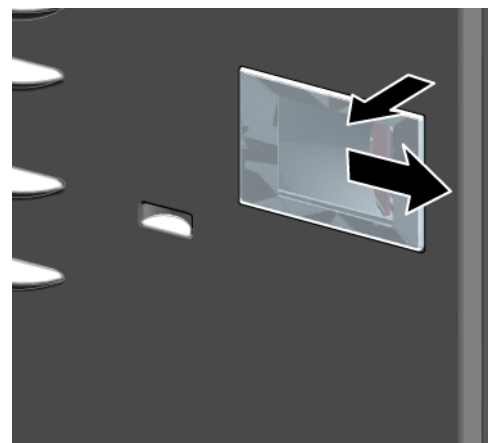

Reparasjon

3. Løsne LED -spotlightmodulen.

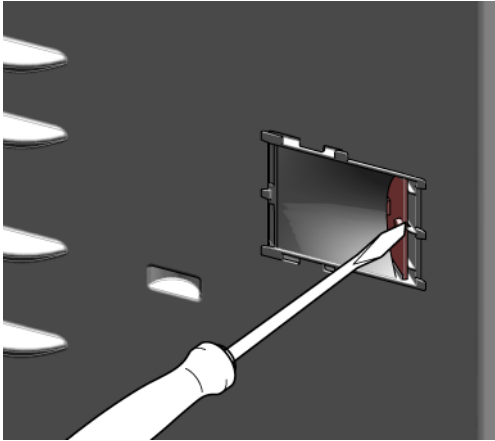

4. Koble fra den elektriske tilkoblingen for LED-spotlight.

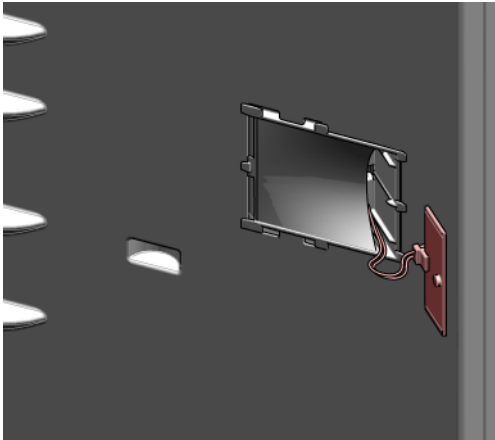

 LED-spotlight er demontert.

4.17.2 Montering av LED-spotlight

▶ Monteres i motsatt rekkefølge.

Wskazówki naprawy - Chłodziarko-zamrażarka

Informacje dotyczące dokumentu 467

1.1	Ważne informacje.....	467
1.1.1	Cel dokumentu	467
1.2	Objaśnienie symboli ostrzegawczych.....	467
1.2.1	Oznaczenie poziomów niebezpieczeństwa	467
1.2.2	Symbole ostrzegawcze.....	467
1.2.3	Budowa ostrzeżeń	468
1.2.4	Ogólne symbole.....	468

Bezpieczeństwo..... 469

2.1	Ogólne informacje dotyczące bezpieczeństwa.....	469
2.1.1	Wszystkie sprzęty gospodarstwa domowego	469

Narzędzia i pomoce techniczne..... 470

Naprawy..... 471

4.1	Wymiana uszczelki drzwiczek	471
4.1.1	Demontaż uszczelki drzwiczek.....	471
4.1.2	Montaż uszczelki drzwiczek.....	471
4.2	Wymiana uchwyty drzwiczek.....	474
4.2.1	Demontaż uchwyty drzwiczek	474
4.2.2	Montaż uchwyty drzwiczek	474
4.3	Wymiana górnego zawiasu drzwiczek.....	475
4.3.1	Demontaż górnego zawiasu drzwiczek.....	475
4.3.2	Montaż górnego zawiasu drzwiczek	476
4.4	Wymiana górnego zawiasu drzwiczek (drzwiczki z wyświetlaczem).....	477
4.4.1	Demontaż górnego zawiasu drzwiczek.....	477
4.4.2	Montaż górnego zawiasu drzwiczek	478
4.5	Wymiana środkowego zawiasu drzwiczek.....	479
4.5.1	Demontaż środkowego zawiasu drzwiczek	479
4.5.2	Montaż środkowego zawiasu drzwiczek	479
4.6	Wymiana dolnego zawiasu drzwiczek	480
4.6.1	Demontaż dolnego zawiasu drzwiczek	480
4.6.2	Montaż dolnego zawiasu drzwiczek.....	480
4.7	Wymiana półki.....	481
4.7.1	Demontaż półki	481
4.7.2	Montaż półki	481

4.8	Wymiana podstawki na butelki	482
4.8.1	Demontaż podstawki na butelki	482
4.8.2	Montaż podstawki na butelki	482
4.9	Wymiana półki drzwiczek.....	483
4.9.1	Demontaż półki drzwiczek.....	483
4.9.2	Montaż półki drzwiczek	483
4.10	Wymiana regulowanej półki drzwiczek.....	484
4.10.1	Demontaż regulowanej półki drzwiczek.....	484
4.10.2	Montaż regulowanej półki drzwiczek	484
4.11	Wymiana pojemnika na mrożoną żywność	485
4.11.1	Demontaż pojemnika na mrożoną żywność.....	485
4.11.2	Montaż pojemnika na mrożoną żywność	485
4.12	Wymiana pojemnika	486
4.12.1	Demontaż pojemnika	486
4.12.2	Montaż pojemnika	486
4.13	Wymiana pojemnika wysuwanego.....	487
4.13.1	Demontaż pojemnika wysuwanego.....	487
4.13.2	Montaż pojemnika wysuwanego	487
4.14	Wymiana oświetlenia punktowego LED	488
4.14.1	Demontaż oświetlenia punktowego LED	488
4.14.2	Montaż oświetlenia punktowego LED.....	488
4.15	Wymiana górnego oświetlenia LED	489
4.15.1	Demontaż oświetlenia LED	489
4.15.2	Montaż górnego oświetlenia LED	490
4.16	Wymiana bocznego paska oświetleniowego LED.....	491
4.16.1	Demontaż bocznego paska oświetleniowego LED	491
4.16.2	Montaż bocznego paska oświetleniowego LED	492
4.17	Wymiana oświetlenia punktowego LED	493
4.17.1	Demontaż oświetlenia punktowego LED	493
4.17.2	Montaż oświetlenia punktowego LED.....	494

i Informacje dotyczące dokumentu

1.1 Ważne informacje

1.1.1 Cel dokumentu

Niniejsze wskazówki naprawcze mają na celu zapewnienie użytkownikowi pomocy w samodzielnej naprawie posiadanych urządzeń w sposób zgodny z obowiązującymi przepisami w sprawie ekoprojektu (stan na 03/2021).

Zawierają one informacje na temat wymiany określonych części zamiennych oraz ostrzeżenia i informacje o zagrożeniach.

W razie pytań należy się skontaktować z naszym działem serwisowym. Odpowiedzialność za szkody ponosimy tylko pod warunkiem prawidłowego stosowania się do wskazówek naprawczych.

1.2 Objasnienie symboli ostrzegawczych

1.2.1 Oznaczenie poziomów niebezpieczeństwa

Poziom ryzyka jest określany przy pomocy symbolu oraz wyrazu. Wyraz określa poziom ryzyka.



Symbol	Znaczenie
 NIEBEZPIECZEŃSTWO	Bezpośrednio zagrażające niebezpieczeństwo, które przy niezachowaniu odpowiednich środków ostrożności może doprowadzić do śmierci lub poważnych obrażeń.
 OSTRZEŻENIE	Prawdopodobieństwo wystąpienia niebezpieczeństwa, które przy niezachowaniu odpowiednich środków ostrożności może doprowadzić do śmierci lub poważnych obrażeń.
 WAŻNE	Prawdopodobieństwo wystąpienia niebezpieczeństwa, które przy niezachowaniu odpowiednich środków ostrożności może doprowadzić do powstania lekkich obrażeń.
UWAGA!	Ostrzeżenie dot. możliwości powstania szkody materialnej.

Tabela 1: Oznaczenie poziomów niebezpieczeństwa

1.2.2 Symbole ostrzegawcze

Symbole ostrzegawcze reprezentują graficznie źródło potencjalnego ryzyka.

W poniższym dokumencie użyto następujących symboli:

Symbole ostrzegawcze	Znaczenie
	Ogólne ostrzeżenie
	Niebezpieczeństwo od napięcia elektrycznego
	Ryzyko wybuchu

i Informacje dotyczące dokumentu







Symbole ostrzegawcze	Znaczenie
	Ryzyko obrażeń (rozcięć)
	Ryzyko zmiążdżenia
	Ryzyko oparzenia
	Silne pole magnetyczne
	Promieniowanie nie-jonizujące

Tabela 2: Symbole ostrzegawcze

1.2.3 Budowa ostrzeżeń

Ostrzeżenia podane w dokumencie mają standardową budowę.

	<p>⚠ NIEBEZPIECZEŃSTWO</p> <p>Typ i źródło ryzyka!! Konsekwencje zignorowania. ▶ Środki ochronne.</p>
---	---

Kolejne ostrzeżenie wskazuje, jako źródło możliwość porażenia prądem. Wskazano czynności, które mają za zadanie ograniczenie ryzyka.

	<p>⚠ NIEBEZPIECZEŃSTWO</p> <p>Ryzyko porażenia prądem, ze względu na elementy będące pod napięciem! Zagrożenie życia poprzez porażenie prądem ▶ Odłączyć urządzenie od zasilania sieciowego na 60 sekund przed rozpoczęciem naprawy.</p>
--	--

1.2.4 Ogólne symbole

Poniższe symbole są używane w dokumentacji:







Symbol	Znaczenie
	Identyfikacja specjalnej wskazówki (tekst lub grafika)
	Identyfikacja prostej wskazówki (tylko tekst)
	Identyfikacja linku do pliku wideo
	Identyfikacja narzędzi
	Identyfikacja wstępnych warunków
	Identyfikacja warunku (jeżeli)
	Identyfikacja rezultatu
[Start]	Identyfikacja przycisku
[00123456]	Identyfikacja numeru materiału
Status	Identyfikacja wyświetlanego tekstu / komunikatu (na wyświetlaczu)

Tabela 3: Ogólne symbole

2.1 Ogólne informacje dotyczące bezpieczeństwa

2.1.1 Wszystkie sprzęty gospodarstwa domowego

Ryzyko porażenia prądem elektrycznym wskutek kontaktu z elementami znajdującymi się pod napięciem!

- Błędna naprawa części elektrycznych może spowodować porażenie prądem elektrycznym!
- Co najmniej 60 sekund przed przystąpieniem do pracy odłączyć urządzenie od sieci elektrycznej.
- Po naprawie należy przeprowadzić test bezpieczeństwa zgodny z przepisami normy VDE 0701 (Niemcy) lub odpowiednimi przepisami obowiązującymi w kraju użytkowania.

Ryzyko zranienia o ostre krawędzie!

- Używać rękawic ochronnych.

Ryzyko zmiążdżenia podczas naprawy, obsługi lub diagnozy, ze względu na ciężkie i ruchome elementy

- Stosować obuwie ochronne.
- Zabezpieczyć ciężkie elementy przed upadkiem.
- Nie dotykać ruchomych elementów podczas pracy urządzenia.





Zagrożenie dla bezpieczeństwa użytkownika i działania urządzenia!

- Używać tylko oryginalnych części zamiennych.

Ryzyko uszkodzenia komponentów wrażliwych na wyładowania elektrostatyczne (ESD)!

- Nie dotykać modułów, włącznie ze złączami i ścieżkami przewodzącymi.

Narzędzia i pomoce techniczne

Przeznaczenie	Detale	Zdjęcia
Tkanina ochronna [00342013]	60 cm x 50 cm	
Śrubokręt z końcówką płaską	Końcówka 2,4 mm x 0,4 mm x 60 mm, w zestawie [00341820]	
Narzędzie specjalne [00342180]		
Przyssawka [00342224]	Ø50 mm	
Torx Bit TX20 [00340865]	6,3 mm (1/4")	
Śrubokręt z końcówką płaską	Końcówka 10 mm x 1,6 mm x 200 mm	

4.1 Wymiana uszczelki drzwiczek

Warunek:

- ✔ Drzwiczki są otwarte.

4.1.1 Demontaż uszczelki drzwiczek

1. Poluzować uszczelkę drzwiczek w rowku w prawym i lewym narożniku.





2. Wyciągnąć uszczelkę drzwiczek z rowka.



- ➡ Uszczelka drzwiczek została zdemontowana.

4.1.2 Montaż uszczelki drzwiczek

	Grubość nowej uszczelki drzwiczek może się nieco różnić od grubości starej uszczelki drzwiczek. Nie ma to wpływu na jakość zamykania drzwiczek i i działanie urządzenia.
	Jeżeli urządzenie posiada regulowane zawiasy lub elementy mocujące zawiasów, można przy ich użyciu regulować sposób zamykania drzwiczek.
	Małe boczne otwory w uszczelce drzwiczek są elementami funkcyjnymi (zapewniają wentylację). Nie stanowią one wad produkcyjnych.

1. Skontrolować rowek uszczelki pod kątem uszkodzeń.



4. Wcisnąć narożniki uszczelki do rowka u dołu i u góry.



2.  Jeżeli rowek uszczelki jest uszkodzony.
- Skontaktować się z serwisem.

3.  Lekka deformacja uszczelki drzwiczek jest normalna i nie wpływa na jej funkcję. Zaleca się wyprostowanie uszczelki drzwiczek przed jej zamocowaniem w urządzeniu.

Ogrzać uszczelkę drzwiczek suszarką do włosów lub nadać jej żądany kształt rękami.



5. Krok po kroku wcisnąć uszczelkę do rowka na całym obwodzie.





 Uszczelka drzwiczek została zamontowana.

4.2 Wymiana uchwyty drzwiczek

Pomoce specjalne

-  Torx Bit TX20 6,3 mm (1/4") [00340865]
-  Śrubokręt z końcówką płaską Końcówka 10 mm x 1,6 mm x 200 mm

Warunek:

-  Urządzenie jest odłączone od źródła zasilania energią elektryczną.
-  Drzwiczki są otwarte.

4.2.1 Demontaż uchwyty drzwiczek

- ▶ 1. Wykręcić dwie zaślepki gwintowane (1).
- ▶ 2. Wykręcić dwie śruby (2).
- ▶ 3. Zdjąć uchwyt drzwiczek (3).

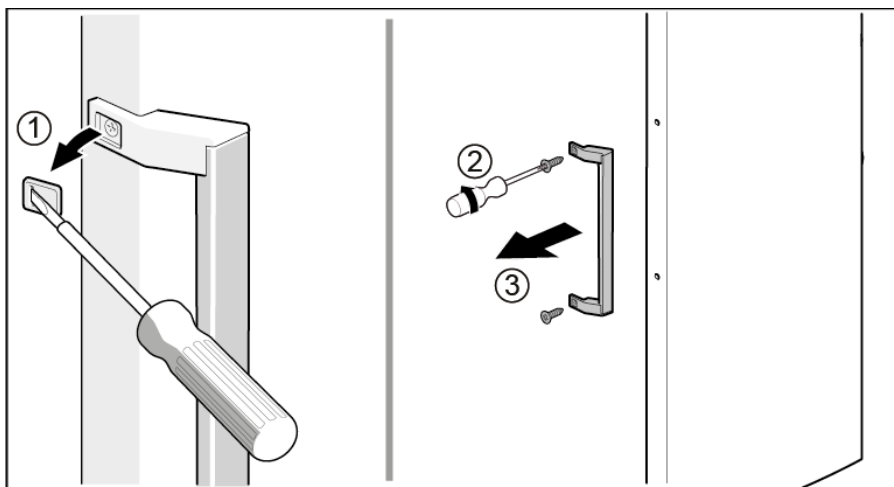

 Uchwyt drzwiczek został zdemontowany.



Uchwyt drugich drzwiczek można zdemontować w taki sam sposób.

4.2.2 Montaż uchwyty drzwiczek

- ▶ Montaż w odwrotnej kolejności.

4.3 Wymiana górnego zawiasu drzwiczek

Pomoce specjalne

Torx Bit TX20

6,3 mm (1/4")

[00340865]

	⚠ OSTRZEŻENIE
	<p>Ciężkie, nieporęczne urządzenia! Kontuzje mięśni i pleców</p> <ul style="list-style-type: none"> ▶ Czynność demontażu drzwiczek urządzenia powinna być wykonywana tylko przez wyszkolonych techników. ▶ Przemieszczenie urządzenia wymaga udziału dwóch osób. ▶ Używać tylko odpowiednich narzędzi i sprzętu.

	⚠ WAŻNE
	<p>Ostre krawędzie! Rany cięte</p> <ul style="list-style-type: none"> ▶ Zawsze używaj rękawic ochronnych.

	⚠ OSTRZEŻENIE
	<p>Możliwość wyslizgnięcia się przechylnego urządzenia! Złamania kości / zmiżdżenia</p> <ul style="list-style-type: none"> ▶ Zabezpieczyć urządzenia przed wyslizgnięciem.

	⚠ WAŻNE
	<p>Niebezpieczeństwo spadnięcia części po wykręceniu śrub! Zranienie przez spadające części.</p> <ul style="list-style-type: none"> ▶ Zabezpieczyć część przed spadnięciem.

	UWAGA!
	<p>Niebezpieczeństwo spadnięcia części po wykręceniu śrub! Uszkodzenie innych części urządzenia albo pomieszczenia mieszkalnego, np. podłogi.</p> <ul style="list-style-type: none"> ▶ Zabezpieczyć część przed spadnięciem.

Warunek:

- ✓ Urządzenie jest odłączone od źródła zasilania energią elektryczną.
- ✓ Zostały zdemontowane wewnętrzne elementy mocujące urządzenia.

4.3.1 Demontaż górnego zawiasu drzwiczek

1. Położyć urządzenie "na plecach".

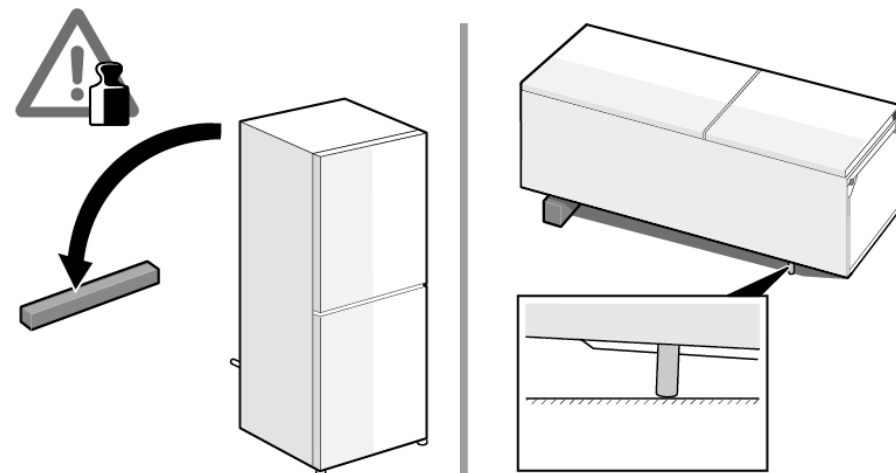

Naprawy

2. 1. Nacisnąć osłony zawiasów górnych po obu stronach (1).
2. Przesunąć osłonę zawiasu górnego (2).
3. Obrócić osłonę zawiasu (3).
4. Zdjąć osłonę zawiasu górnego (4).
5. Wykręcić dwie śruby (5).
6. Wyjąć zawias górny (6).

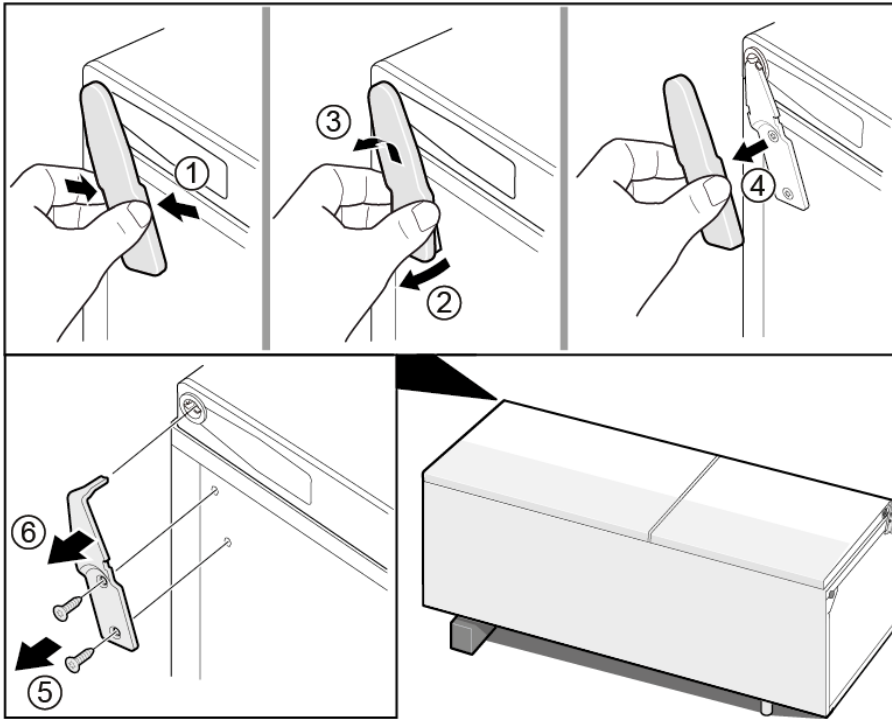

 Górny zawias jest zdemontowany.

4.3.2 Montaż górnego zawiasu drzwiczek

- ▶ Montaż w odwrotnej kolejności.

4.4 Wymiana górnego zawiasu drzwiczek (drzwiczki z wyświetlaczem)

Pomoce specjalne

Torx Bit TX20 6,3 mm (1/4") [00340865]

	⚠ OSTRZEŻENIE
	<p>Ciężkie, nieporęczne urządzenia! Kontuzje mięśni i pleców</p> <ul style="list-style-type: none"> ▶ Czynność demontażu drzwiczek urządzenia powinna być wykonywana tylko przez wyszkolonych techników. ▶ Przemieszczenie urządzenia wymaga udziału dwóch osób. ▶ Używać tylko odpowiednich narzędzi i sprzętu.

	⚠ WAŻNE
	<p>Ostre krawędzie! Rany cięte</p> <ul style="list-style-type: none"> ▶ Zawsze używaj rękawic ochronnych.

	⚠ OSTRZEŻENIE
	<p>Możliwość wyslizgnięcia się przechylnego urządzenia! Złamania kości / zmiążdżenia</p> <ul style="list-style-type: none"> ▶ Zabezpieczyć urządzenia przed wyslizgnięciem.

	⚠ WAŻNE
	<p>Niebezpieczeństwo spadnięcia części po wykręceniu śrub! Zranienie przez spadające części.</p> <ul style="list-style-type: none"> ▶ Zabezpieczyć część przed spadnięciem.

	UWAGA!
	<p>Niebezpieczeństwo spadnięcia części po wykręceniu śrub! Uszkodzenie innych części urządzenia albo pomieszczenia mieszkalnego, np. podłogi.</p> <ul style="list-style-type: none"> ▶ Zabezpieczyć część przed spadnięciem.

	⚠ NIEBEZPIECZEŃSTWO
	<p>Ryzyko porażenia prądem elektrycznym wskutek kontaktu z elementami znajdującymi się pod napięciem! Niebezpieczeństwo utraty życia wskutek porażenia prądem elektrycznym w przypadku nieprawidłowej naprawy</p> <ul style="list-style-type: none"> ▶ Części elektryczne powinny być naprawiane przez wykwalifikowanych elektryków. ▶ Po naprawie należy przeprowadzić test bezpieczeństwa zgodny z przepisami normy VDE 0701 (Niemcy) lub odpowiednimi przepisami obowiązującymi w kraju użytkowania.

	⚠ NIEBEZPIECZEŃSTWO
	<p>Ryzyko porażenia prądem, ze względu na elementy będące pod napięciem! Zagrożenie życia poprzez porażenie prądem</p> <ul style="list-style-type: none"> ▶ Odłączyć urządzenie od zasilania sieciowego na 60 sekund przed rozpoczęciem naprawy.

Warunek:

- ✔ Urządzenie jest odłączone od źródła zasilania energią elektryczną.
- ✔ Zostały zdemontowane wewnętrzne elementy mocujące urządzenia.

4.4.1 Demontaż górnego zawiasu drzwiczek

1. Położyć urządzenie "na plecach".

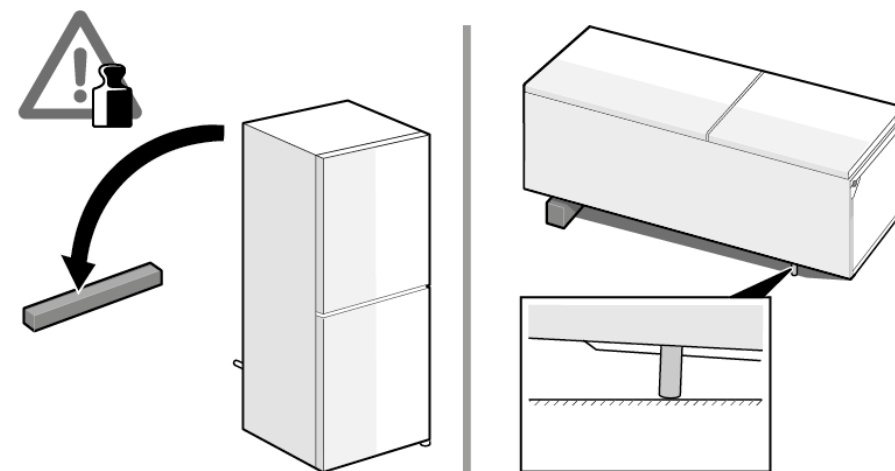

Naprawy

2. 1. Zdjąć osłonę zawiasu górnego (1).
2. Zdjąć pokrywę puszki kablowej (2).
3. Odłączyć złącze elektryczne (3).
4. Odkręcić śrubę złącza uziemienia (4).
5. Wyjąć osłonę kabli (5).
6. Odkręcić śrubę (6)

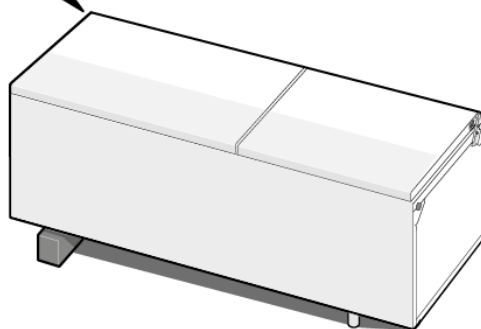
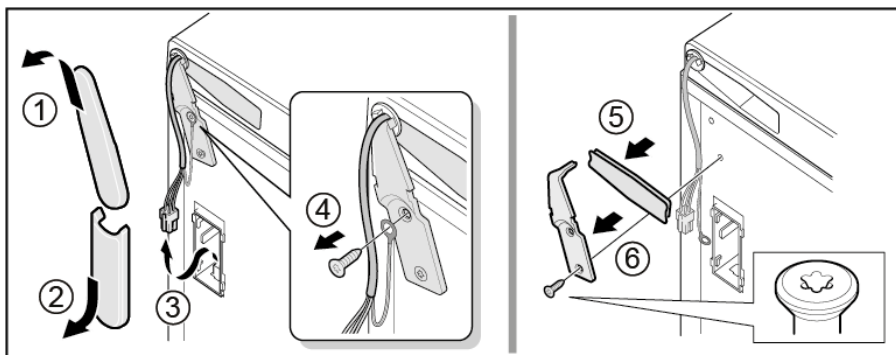

 Górny zawias jest zdemontowany.

4.4.2 Montaż górnego zawiasu drzwiczek

- ▶ Montaż w odwrotnej kolejności.

4.5 Wymiana środkowego zawiasu drzwiczek

Pomoce specjalne

Torx Bit TX20 6,3 mm (1/4") [00340865]

	⚠ OSTRZEŻENIE
	<p>Ciężkie, nieporęczne urządzenia! Kontuzje mięśni i pleców</p> <ul style="list-style-type: none"> ▶ Czynność demontażu drzwiczek urządzenia powinna być wykonywana tylko przez wyszkolonych techników. ▶ Przemieszczenie urządzenia wymaga udziału dwóch osób. ▶ Używać tylko odpowiednich narzędzi i sprzętu.

	⚠ WAŻNE
	<p>Ostre krawędzie! Rany cięte</p> <ul style="list-style-type: none"> ▶ Zawsze używaj rękawic ochronnych.

	⚠ OSTRZEŻENIE
	<p>Możliwość wyslizgnięcia się przechylonego urządzenia! Złamania kości / zmiężdżenia</p> <ul style="list-style-type: none"> ▶ Zabezpieczyć urządzenia przed wyslizgnięciem.

	⚠ WAŻNE
	<p>Niebezpieczeństwo spadnięcia części po wykręceniu śrub! Zranienie przez spadające części.</p> <ul style="list-style-type: none"> ▶ Zabezpieczyć część przed spadnięciem.

	UWAGA!
	<p>Niebezpieczeństwo spadnięcia części po wykręceniu śrub! Uszkodzenie innych części urządzenia albo pomieszczenia mieszkalnego, np. podłogi.</p> <ul style="list-style-type: none"> ▶ Zabezpieczyć część przed spadnięciem.

Warunek:

- ✔ Urządzenie jest odłączone od źródła zasilania energią elektryczną.
- ✔ Zostały zdemontowane wewnętrzne elementy mocujące urządzenia.
- ✔ Górny zawias drzwiczek jest zdemontowany.

4.5.1 Demontaż środkowego zawiasu drzwiczek

- ▶ 1. Zdemontować drzwiczki komory chłodziarki (1).
- ▶ 2. Wykręcić dwie śruby (2).
- ▶ 3. Wyjąć środkowy zawias (3).

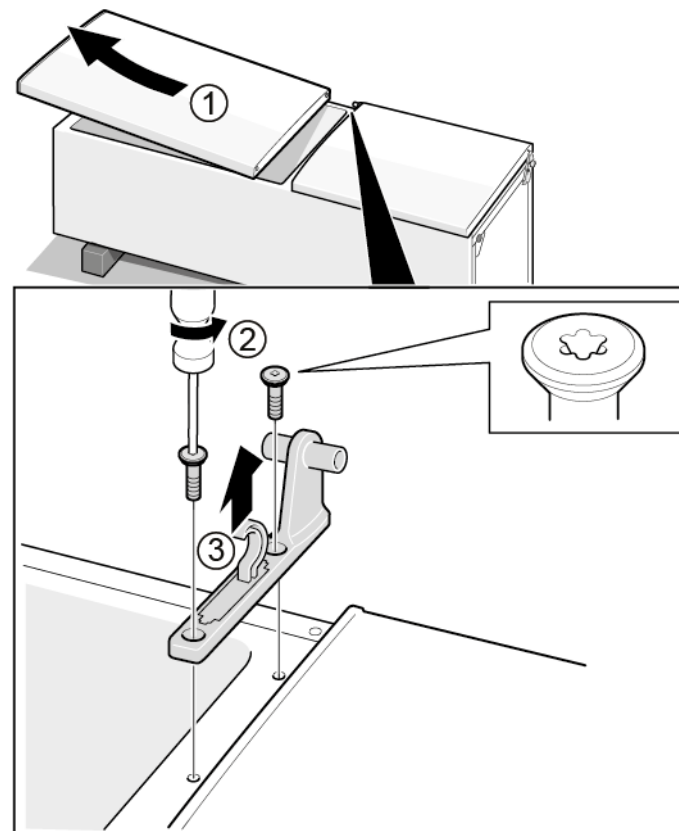

➡ Środkowy zawias jest zdemontowany.

4.5.2 Montaż środkowego zawiasu drzwiczek

- ▶ Montaż w odwrotnej kolejności.

4.6 Wymiana dolnego zawiasu drzwiczek

Pomoce specjalne

Torx Bit TX20 6,3 mm (1/4") [00340865]

	⚠ OSTRZEŻENIE
	<p>Ciężkie, nieporęczne urządzenia! Kontuzje mięśni i pleców</p> <ul style="list-style-type: none"> ▶ Czynność demontażu drzwiczek urządzenia powinna być wykonywana tylko przez wyszkolonych techników. ▶ Przemieszczenie urządzenia wymaga udziału dwóch osób. ▶ Używać tylko odpowiednich narzędzi i sprzętu.

	⚠ WAŻNE
	<p>Ostre krawędzie! Rany cięte</p> <ul style="list-style-type: none"> ▶ Zawsze używaj rękawic ochronnych.

	⚠ OSTRZEŻENIE
	<p>Możliwość wyslizgnięcia się przechylonego urządzenia! Złamania kości / zmiążdżenia</p> <ul style="list-style-type: none"> ▶ Zabezpieczyć urządzenia przed wyslizgnięciem.

	⚠ WAŻNE
	<p>Niebezpieczeństwo spadnięcia części po wykręceniu śrub! Zranienie przez spadające części.</p> <ul style="list-style-type: none"> ▶ Zabezpieczyć część przed spadnięciem.

	UWAGA!
	<p>Niebezpieczeństwo spadnięcia części po wykręceniu śrub! Uszkodzenie innych części urządzenia albo pomieszczenia mieszkalnego, np. podłogi.</p> <ul style="list-style-type: none"> ▶ Zabezpieczyć część przed spadnięciem.

Warunek:

- ✔ Urządzenie jest odłączone od źródła zasilania energią elektryczną.
- ✔ Zostały zdemontowane wewnętrzne elementy mocujące urządzenia.
- ✔ Górny zawias jest zdemontowany.

✔ Środkowy zawias jest zdemontowany.

4.6.1 Demontaż dolnego zawiasu drzwiczek

- ▶ 1. Zdemontować drzwiczki komory zamrażarki (1).
- ▶ 2. Odkręcić śrubę (2).
- ▶ 3. Obrócić zawias dolny do zewnątrz (3).
- ▶ 4. Wyjąć zawias dolny (4).

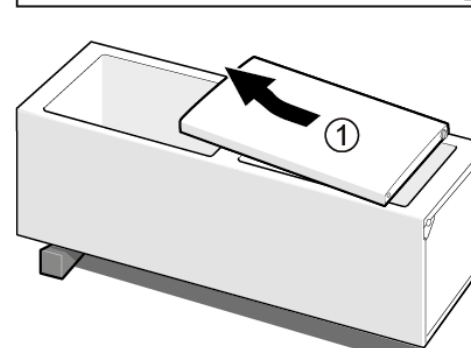
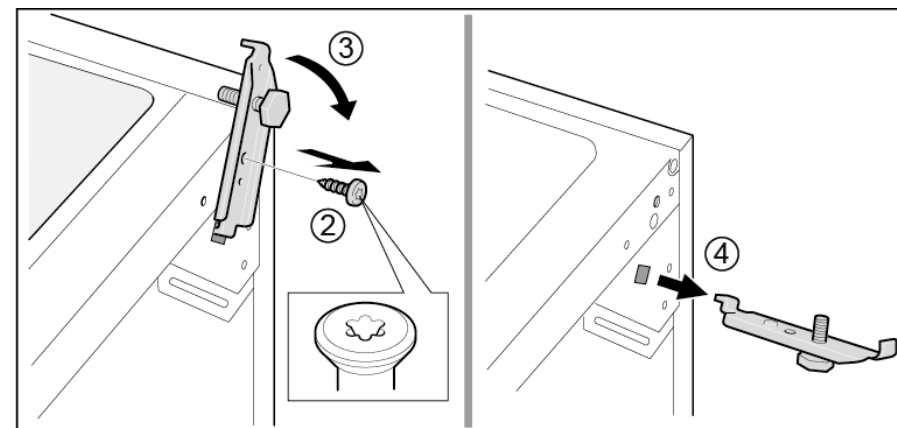

➡ Dolny zawias drzwiczek jest zdemontowany.

4.6.2 Montaż dolnego zawiasu drzwiczek

- ▶ Montaż w odwrotnej kolejności.

4.7 Wymiana półki

Warunek:

- ✔ Drzwiczki są otwarte.

4.7.1 Demontaż półki

- ▶ Wyciągnąć półkę.

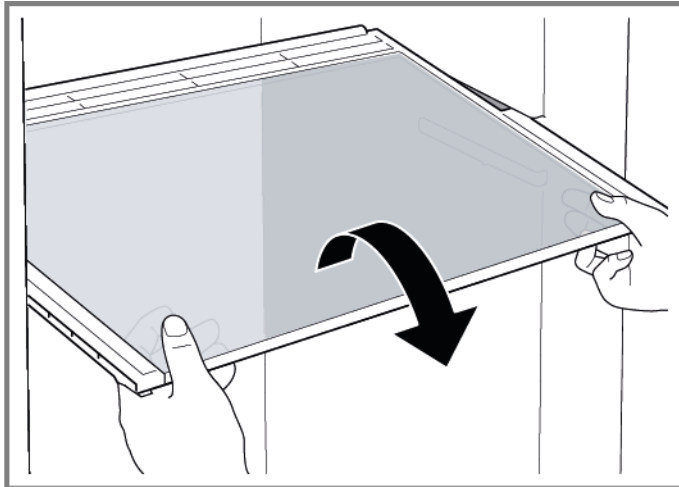

- ➡ Półka jest wyjęta.

4.7.2 Montaż półki

- ▶ Montaż w odwrotnej kolejności.

4.8 Wymiana podstawki na butelki

Warunek:

- ✔ Drzwiczki są otwarte.

4.8.1 Demontaż podstawki na butelki

- ▶ Wyciągnąć podstawkę na butelki.

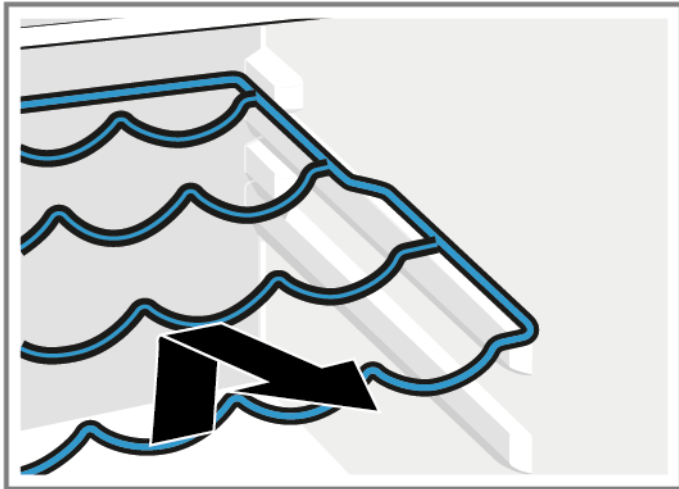

- ➡ Podstawka na butelki jest wyjęta.

4.8.2 Montaż podstawki na butelki

- ▶ Montaż w odwrotnej kolejności.

4.9 Wymiana półki drzwiczek

Warunek:

- ✔ Drzwiczki są otwarte.

4.9.1 Demontaż półki drzwiczek

- ▶ Podnieść półkę drzwiczek do góry.

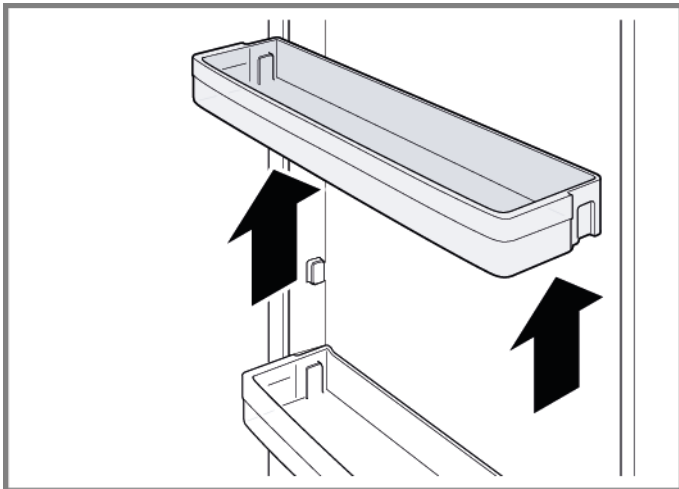

- ➡ Półka drzwiczek została zdemontowana.

4.9.2 Montaż półki drzwiczek

- ▶ Montaż w odwrotnej kolejności.

4.10 Wymiana regulowanej półki drzwiczek

Warunek:

- ✔ Drzwiczki są otwarte.

4.10.1 Demontaż regulowanej półki drzwiczek

- ▶ Przesunąć półkę o regulowanej wysokości do góry tak, by została odblokowana w uchwycie.

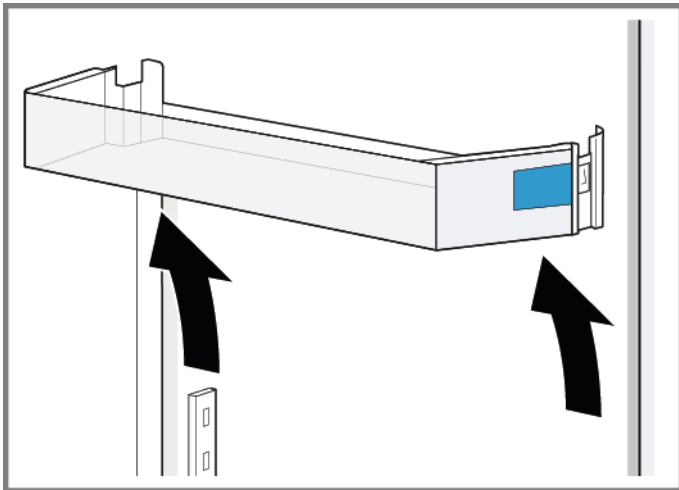

- ➡ Regulowana półka drzwiczek została wyjęta.

4.10.2 Montaż regulowanej półki drzwiczek

- ▶ Montaż w odwrotnej kolejności.

4.11 Wymiana pojemnika na mrożoną żywność

Warunek:

- ✔ Drzwiczki są otwarte.

4.11.1 Demontaż pojemnika na mrożoną żywność

- ▶ 1. Wyciągnąć pojemnik na mrożoną żywność do końca (1).
- ▶ 2. Wyjąć pojemnik na żywność (2).

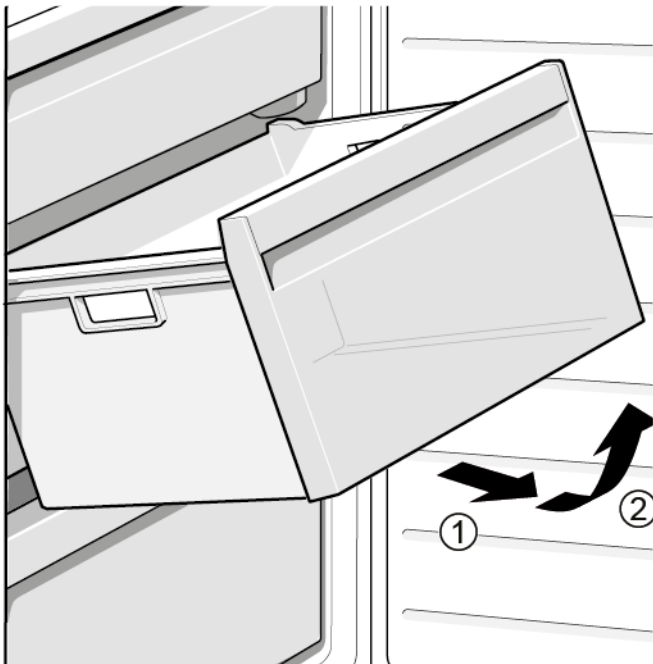

- ➡ Pojemnik na mrożoną żywność został wyjęty.

4.11.2 Montaż pojemnika na mrożoną żywność

- ▶ Montaż w odwrotnej kolejności.

4.12 Wymiana pojemnika

Warunek:

- ✔ Drzwiczki są otwarte.

4.12.1 Demontaż pojemnika

- ▶ 1. Wyjąć dolny pojemnik chłodziarki (1).
- ▶ 2. Wyjąć górny pojemnik chłodziarki (2).

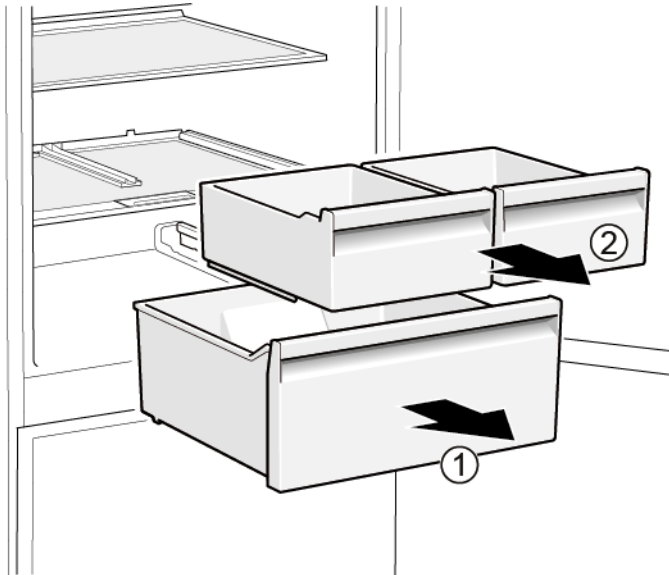

- ➡ Pojemniki zostały wyjęte.

4.12.2 Montaż pojemnika

- ▶ Montaż w odwrotnej kolejności.

4.13 Wymiana pojemnika wysuwanego

Warunek:

- ✔ Drzwiczki są otwarte.

4.13.1 Demontaż pojemnika wysuwanego

- ▶ 1. Wyciągnąć pojemnik wysuwany do końca (1).
- ▶ 2. Wyjąć pojemnik wysuwany (2).

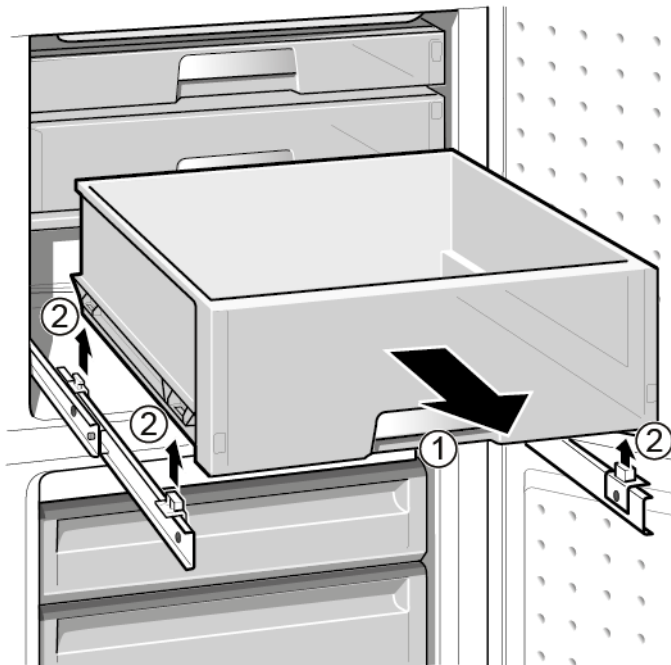

- ➡ Pojemnik wysuwany został wyjęty.

4.13.2 Montaż pojemnika wysuwanego

- ▶ Montaż w odwrotnej kolejności.

4.14 Wymiana oświetlenia punktowego LED

Pomoce specjalne

Narzędzie specjalne [00342180]

i Urządzenie posiada bezobsługowe oświetlenie LED. Tego rodzaju elementy oświetleniowe mogą być naprawiane wyłącznie przez serwis lub autoryzowanych techników!

⚠ NIEBEZPIECZEŃSTWO
Ryzyko porażenia prądem elektrycznym wskutek kontaktu z elementami znajdującymi się pod napięciem!
 Niebezpieczeństwo utraty życia wskutek porażenia prądem elektrycznym w przypadku nieprawidłowej naprawy

- ▶ Części elektryczne powinny być naprawiane przez wykwalifikowanych elektryków.
- ▶ Po naprawie należy przeprowadzić test bezpieczeństwa zgodny z przepisami normy VDE 0701 (Niemcy) lub odpowiednimi przepisami obowiązującymi w kraju użytkownika.

⚠ NIEBEZPIECZEŃSTWO
Ryzyko porażenia prądem, ze względu na elementy będące pod napięciem!
 Zagrożenie życia poprzez porażenie prądem

- ▶ Odłączyć urządzenie od zasilania sieciowego na 60 sekund przed rozpoczęciem naprawy.

⚠ WAŻNE
Ostre krawędzie!
 Rany cięte

- ▶ Zawsze używaj rękawic ochronnych.

Warunek:

- ✓ Urządzenie jest odłączone od źródła zasilania energią elektryczną.
- ✓ Drzwiczki są otwarte.

4.14.1 Demontaż oświetlenia punktowego LED

1. Przy użyciu specjalnego narzędzia wyjąć oświetlenie punktowe LED (1).

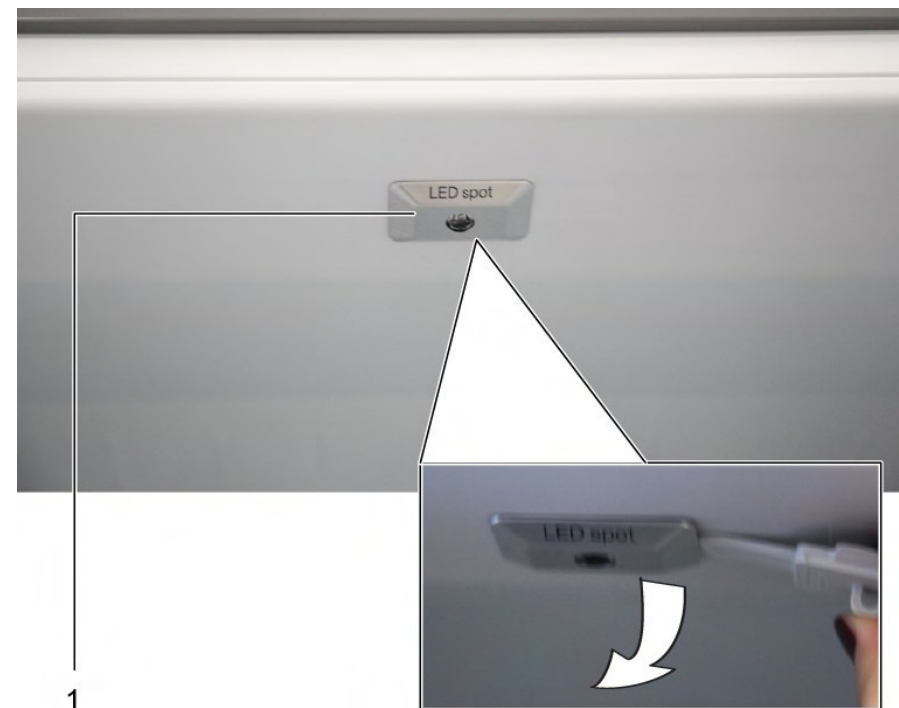

2. Odłączyć złącza elektryczne oświetlenia punktowego LED.
- ➡ Oświetlenie punktowe LED zostało wymontowane.

4.14.2 Montaż oświetlenia punktowego LED

- ▶ Montaż w odwrotnej kolejności.

4.15 Wymiana górnego oświetlenia LED

Pomoce specjalne

- Śrubokręt z końcówką płaską Końcówka 2,4 mm x 0,4 mm x 60 mm, w zestawie [00341820]

	Urządzenie posiada bezobsługowe oświetlenie LED. Tego rodzaju elementy oświetleniowe mogą być naprawiane wyłącznie przez serwis lub autoryzowanych techników!
---	---

	<p>⚠ NIEBEZPIECZEŃSTWO</p> <p>Ryzyko porażenia prądem elektrycznym wskutek kontaktu z elementami znajdującymi się pod napięciem!</p> <p>Niebezpieczeństwo utraty życia wskutek porażenia prądem elektrycznym w przypadku nieprawidłowej naprawy</p> <ul style="list-style-type: none"> ▶ Części elektryczne powinny być naprawiane przez wykwalifikowanych elektryków. ▶ Po naprawie należy przeprowadzić test bezpieczeństwa zgodny z przepisami normy VDE 0701 (Niemcy) lub odpowiednimi przepisami obowiązującymi w kraju użytkowania.
--	---

	<p>⚠ NIEBEZPIECZEŃSTWO</p> <p>Ryzyko porażenia prądem, ze względu na elementy będące pod napięciem!</p> <p>Zagrożenie życia poprzez porażenie prądem</p> <ul style="list-style-type: none"> ▶ Odłączyć urządzenie od zasilania sieciowego na 60 sekund przed rozpoczęciem naprawy.
--	---

	<p>⚠ WAŻNE</p> <p>Ostre krawędzie!</p> <p>Rany cięte</p> <ul style="list-style-type: none"> ▶ Zawsze używaj rękawic ochronnych.
--	--

Warunek:

- ✔ Urządzenie jest odłączone od źródła zasilania energią elektryczną.
- ✔ Drzwiczki są otwarte.
- ✔ Zostały zdemonstrowane górne wewnętrzne elementy mocujące.

4.15.1 Demontaż oświetlenia LED

- Przesunąć oświetlenie LED w lewo.

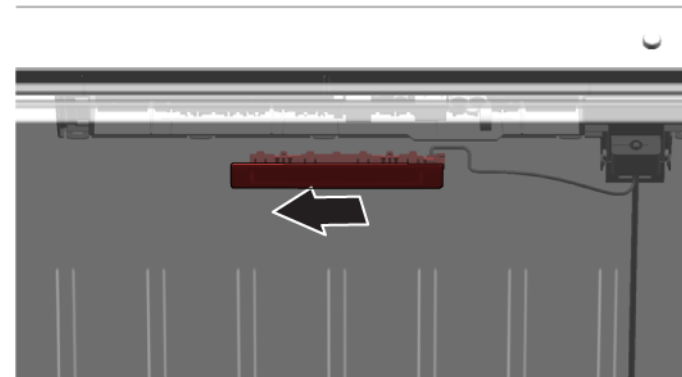

- ➡ Złącze elektryczne oświetlenia LED jest rozłączone.

- Zwolnić zaczepy oświetlenia LED.

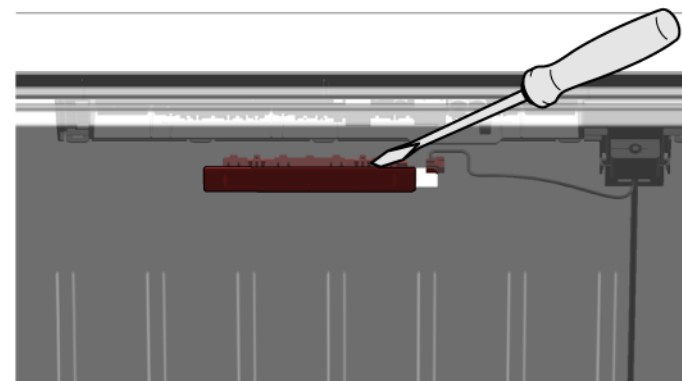

3. Wyjąć oświetlenie LED przez przesunięcie go do przodu.

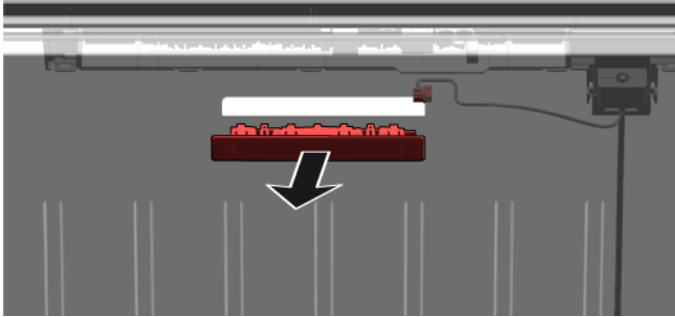

- ➡ Oświetlenie LED zostało wymontowane.

4.15.2 Montaż górnego oświetlenia LED

- ▶ Montaż w odwrotnej kolejności.

4.16 Wymiana bocznego paska oświetleniowego LED

Pomoce specjalne

 Przyssawka Ø50 mm [00342224]

 Urządzenie posiada bezobsługowe oświetlenie LED. Tego rodzaju elementy oświetleniowe mogą być naprawiane wyłącznie przez serwis lub autoryzowanych techników!

 **⚠ NIEBEZPIECZEŃSTWO**
Ryzyko porażenia prądem elektrycznym wskutek kontaktu z elementami znajdującymi się pod napięciem!
 Niebezpieczeństwo utraty życia wskutek porażenia prądem elektrycznym w przypadku nieprawidłowej naprawy

- ▶ Części elektryczne powinny być naprawiane przez wykwalifikowanych elektryków.
- ▶ Po naprawie należy przeprowadzić test bezpieczeństwa zgodny z przepisami normy VDE 0701 (Niemcy) lub odpowiednimi przepisami obowiązującymi w kraju użytkownika.



 **⚠ NIEBEZPIECZEŃSTWO**
Ryzyko porażenia prądem, ze względu na elementy będące pod napięciem!
 Zagrożenie życia poprzez porażenie prądem

- ▶ Odłączyć urządzenie od zasilania sieciowego na 60 sekund przed rozpoczęciem naprawy.

 **⚠ WAŻNE**
Ostre krawędzie!
 Rany cięte

- ▶ Zawsze używaj rękawic ochronnych.

Warunek:

-  Urządzenie jest odłączone od źródła zasilania energią elektryczną.
-  Drzwiczki są otwarte.
-  Z komory chłodziarki zostały wyjęte półki.

4.16.1 Demontaż bocznego paska oświetleniowego LED

1. Przymocować przyssawkę do bocznego paska oświetleniowego LED w obszarze górnej jednej trzeciej jego powierzchni.



2. Pociągnąć przysawkę z bocznym paskiem oświetleniowym LED do przodu jednym obrotowym ruchem.

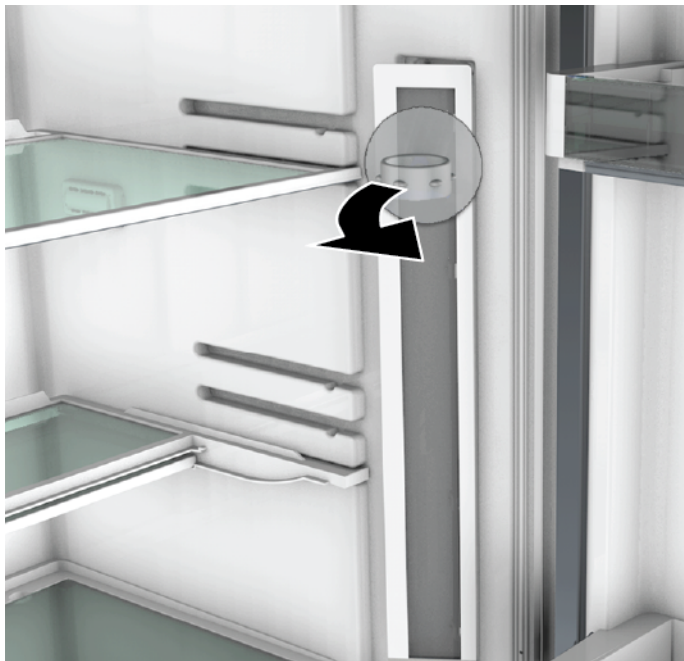

3. Rozłączyć złącze elektryczne bocznego paska oświetleniowego LED.
➡ Boczny pasek oświetleniowy LED został wymontowany.

4.16.2 Montaż bocznego paska oświetleniowego LED

1. Połączyć złącze elektryczne bocznego paska oświetleniowego LED.
 2. Zamocować boczny pasek oświetleniowy LED w przewidzianym dla niego miejscu na ścianie komory (słychać kliknięcia zaczepów).
- ➡ Boczny pasek oświetleniowy LED został zamontowany.

4.17 Wymiana oświetlenia punktowego LED

Pomoce specjalne

- 🔧 Narzędzie specjalne [00342180]
- 🔧 Śrubokręt z końcówką płaską Kończówka 2,4 mm x 0,4 mm x 60 mm, w zestawie [00341820]

i Urządzenie posiada bezobsługowe oświetlenie LED. Tego rodzaju elementy oświetleniowe mogą być naprawiane wyłącznie przez serwis lub autoryzowanych techników!

⚠ NIEBEZPIECZEŃSTWO
Ryzyko porażenia prądem elektrycznym wskutek kontaktu z elementami znajdującymi się pod napięciem!
 Niebezpieczeństwo utraty życia wskutek porażenia prądem elektrycznym w przypadku nieprawidłowej naprawy

- ▶ Części elektryczne powinny być naprawiane przez wykwalifikowanych elektryków.
- ▶ Po naprawie należy przeprowadzić test bezpieczeństwa zgodny z przepisami normy VDE 0701 (Niemcy) lub odpowiednimi przepisami obowiązującymi w kraju użytkownika.

⚠ NIEBEZPIECZEŃSTWO
Ryzyko porażenia prądem, ze względu na elementy będące pod napięciem!
 Zagrożenie życia poprzez porażenie prądem

- ▶ Odłączyć urządzenie od zasilania sieciowego na 60 sekund przed rozpoczęciem naprawy.

⚠ WAŻNE
Ostre krawędzie!
 Rany cięte

- ▶ Zawsze używaj rękawic ochronnych.

Warunek:

- ✔ Urządzenie jest odłączone od źródła zasilania energią elektryczną.
- ✔ Drzwiczki są otwarte.
- ✔ Z komory chłodziarki zostały wyjęte półki.

4.17.1 Demontaż oświetlenia punktowego LED

1. Odblokować pokrywę oświetlenia punktowego LED.

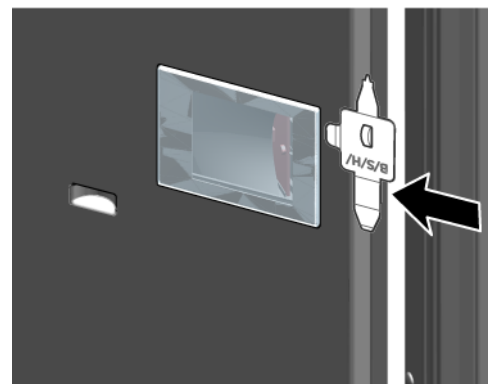

2. Pociągnąć pokrywę oświetlenia punktowego LED do wewnątrz, jednocześnie pochylając ją do przodu.

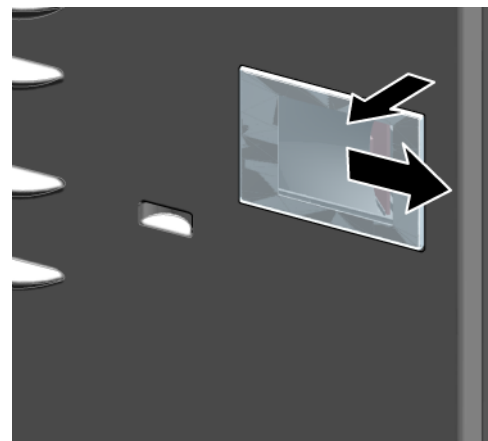

3. Odłączyć moduł oświetlenia punktowego LED.

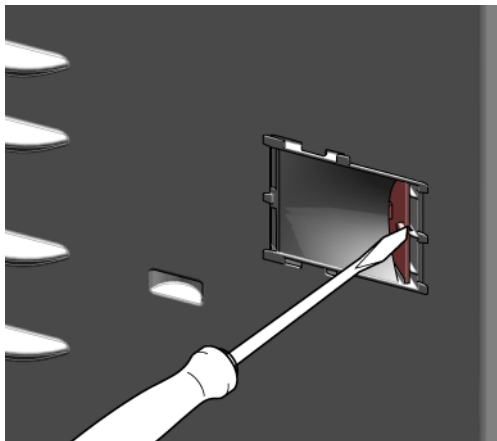

4. Rozłączyć złącze elektryczne oświetlenia punktowego LED.

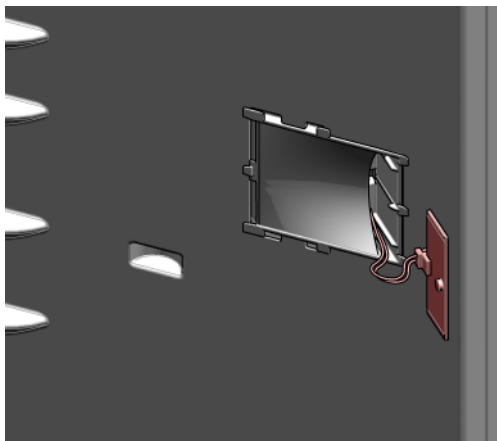





-  Oświetlenie punktowe LED zostało wymontowane.

4.17.2 Montaż oświetlenia punktowego LED

- ▶ Montaż w odwrotnej kolejności.

Dicas de resolução - Combinado de refrigeração/congelação

 Sobre este documento	496	4.8 Substituir o suporte para garrafas	511
1.1 Informação importante	496	4.8.1 Remover o suporte para garrafas	511
1.1.1 Finalidade.....	496	4.8.2 Instalar o suporte para garrafas.....	511
1.2 Explicação dos símbolos.....	496	4.9 Substituir a prateleira da porta	512
1.2.1 Níveis de perigo.....	496	4.9.1 Remover a prateleira da porta	512
1.2.2 Símbolos de perigo	496	4.9.2 Instalar a prateleira da porta.....	512
1.2.3 Estrutura dos avisos.....	497	4.10 Substituir a prateleira da porta ajustável	513
1.2.4 Símbolos gerais	497	4.10.1 Remover a prateleira da porta ajustável.....	513
 Segurança	498	4.10.2 Instalar a prateleira da porta ajustável	513
2.1 Instruções gerais de segurança.....	498	4.11 Substituir o recipiente para alimentos congelados.....	514
2.1.1 Todos os eletrodomésticos	498	4.11.1 Remover o recipiente para alimentos congelados.....	514
 Ferramentas e auxiliares	499	4.11.2 Instalar o recipiente para alimentos congelados	514
 Reparação	500	4.12 Substituir o recipiente	515
4.1 Substituir a junta da porta	500	4.12.1 Remover o recipiente.....	515
4.1.1 Remover a junta da porta	500	4.12.2 Instalar o recipiente	515
4.1.2 Instalar a junta da porta.....	500	4.13 Substituir o recipiente extensível.....	516
4.2 Substituir o puxador da porta	503	4.13.1 Remover o recipiente extensível.....	516
4.2.1 Remover o puxador da porta	503	4.13.2 Instalar o recipiente extensível	516
4.2.2 Instalar o puxador da porta	503	4.14 Substituir a iluminação LED específica.....	517
4.3 Substituir a dobradiça superior da porta.....	504	4.14.1 Remover a iluminação LED específica.....	517
4.3.1 Remover a dobradiça superior da porta.....	504	4.14.2 Instalar a iluminação LED específica	517
4.3.2 Instalar a dobradiça superior da porta	505	4.15 Substituir a iluminação LED superior.....	518
4.4 Substituir a dobradiça superior da porta (porta com visor).....	506	4.15.1 Remover a iluminação LED.....	518
4.4.1 Remover a dobradiça superior da porta.....	506	4.15.2 Instalar a iluminação LED superior	519
4.4.2 Instalar a dobradiça superior da porta	507	4.16 Substituir a iluminação LED de barra lateral	520
4.5 Substituir a dobradiça central da porta	508	4.16.1 Remover a iluminação LED de barra lateral	520
4.5.1 Remover a dobradiça central da porta.....	508	4.16.2 Instalar a iluminação LED de barra lateral.....	521
4.5.2 Instalar a dobradiça central da porta	508	4.17 Substituir a iluminação LED específica.....	522
4.6 Substituir a dobradiça inferior da porta.....	509	4.17.1 Remover a iluminação LED específica.....	522
4.6.1 Remover a dobradiça inferior da porta.....	509	4.17.2 Instalar a iluminação LED específica	523
4.6.2 Instalar a dobradiça inferior da porta	509		
4.7 Substituir a prateleira.....	510		
4.7.1 Remover a prateleira.....	510		
4.7.2 Instalar a prateleira	510		

i Sobre este documento

1.1 Informação importante

1.1.1 Finalidade

Estas dicas de reparação auxiliam o consumidor na reparação de aparelhos por ele próprio de acordo com o regulamento de "Eco-design" aplicável (a partir de 03/2021).

Estas contêm informações sobre como substituir peças sobressalentes definidas, incluindo avisos e riscos.

Em caso de dúvidas, entre em contacto com o nosso serviço de apoio ao cliente. Apenas nos responsabilizaremos por danos se as dicas de reparação tiverem sido devidamente seguidas.

1.2 Explicação dos símbolos

1.2.1 Níveis de perigo

Os níveis de aviso são compostos por um símbolo e uma palavra sinal. A palavra-sinal indica a gravidade do perigo.









Nível de aviso	Significado
	A não observância da mensagem de aviso resulta em morte ou ferimentos graves.
	A não observância da mensagem de aviso pode resultar em morte ou ferimentos graves.
	A não observância da mensagem de aviso pode resultar em ferimentos ligeiros.
	A não observância da mensagem de aviso pode resultar em danos materiais.

Tabela 1: Níveis de perigo

1.2.2 Símbolos de perigo

Os símbolos de perigo são representações simbólicas que dão uma indicação do tipo de perigo.

Neste documento são utilizados os seguintes símbolos de perigo:

Símbolo de perigo	Significado
	Mensagem geral de aviso
	Perigo de tensão elétrica
	Risco de explosão
	Perigo de cortes

i Sobre este documento





Símbolo de perigo	Significado
	Perigo de esmagamento
	Perigo de superfícies quentes
	Perigo de campo eletromagnético intenso
	Perigo de radiação não-ionizante

Tabela 2: Símbolos de perigo

1.2.3 Estrutura dos avisos

Os avisos neste documento possuem um aspeto normalizado e uma estrutura normalizada.

	⚠ PERIGO
Tipo e origem do perigo!	
Possíveis consequência de ignorar o perigo / aviso.	
▶ Medidas e proibições para prevenir o perigo.	

O seguinte exemplo mostra um aviso que adverte contra choques elétricos devido a partes sob tensão. A medida para evitar o perigo é mencionada.

	⚠ PERIGO
Risco de choque elétrico devido a partes sob tensão!	
Morte por eletrocussão	
▶ Desligue os aparelhos da alimentação elétrica pelo menos 60 segundos antes de iniciar as reparações.	

1.2.4 Símbolos gerais

Neste documento são utilizados os seguintes símbolos gerais:







Símbolo ger.	Significado
	Identificação de uma dica especial (texto e/ou ilustração)
	Identificação de uma dica simples (apenas texto)
	Identificação de uma ligação para um tutorial em vídeo
	Identificação das ferramentas necessárias
	Identificação das condições prévias necessárias
	Identificação de uma condição (se ..., então ...)
	Identificação de um resultado
Iniciar	Identificação de uma tecla ou botão
[00123456]	Identificação de um número de material
Estado	Identificação de um texto exibido / janela (no visor do aparelho)

Tabela 3: Símbolos gerais

2.1 Instruções gerais de segurança

2.1.1 Todos os eletrodomésticos

Risco de choque elétrico devido a partes sob tensão!

- Erros por reparações envolvendo componentes elétricos podem provocar choques elétricos!
- Desligue o aparelho da rede elétrica pelo menos 60 segundos antes de iniciar o trabalho.
- Após a reparação, solicite a realização de um teste de segurança de acordo com VDE 0701 ou os regulamentos específicos do país.

Risco de ferimentos causados por arestas vivas!

- Use luvas de proteção.

Risco de esmagamento durante trabalhos de reparação, manutenção, resolução de problemas e serviço devido a componentes pesados e móveis

- Use calçado de proteção.
- Proteja os componentes pesados contra quedas.
- Não introduzir partes do corpo em componentes móveis.





Risco para a segurança/funcionamento do aparelho!

- Utilize apenas peças sobressalentes originais.

Risco de danos em componentes electrostaticamente sensíveis (ESDs)!

- Não toque nos módulos, incluindo ligações e percursos condutores.

Ferramentas e auxiliares

Designação	Detalhes	Imagens
Pano protetor [00342013]	60 cm x 50 cm	
Chave de fendas	Lâmina 2,4 mm x 0,4 mm x 60 mm, no kit [00341820]	
Ferramenta especial [00342180]		
Ventosa [00342224]	Ø50 mm	
Ponta Torx TX20 [00340865]	6,3 mm (1/4")	
Chave de fendas	Lâmina 10 mm x 1,6 mm x 200 mm	

4.1 Substituir a junta da porta

Pré-requisito:

- ✔ A porta está aberta.

4.1.1 Remover a junta da porta

1. Solte a junta da porta da ranhura nos cantos direito e esquerdo.

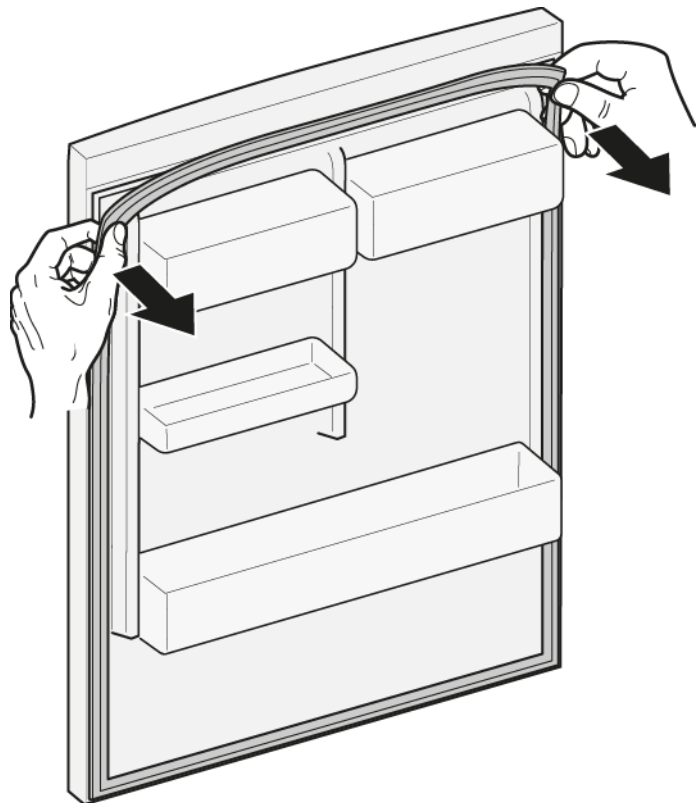

2. Puxe a junta da porta para fora da ranhura.

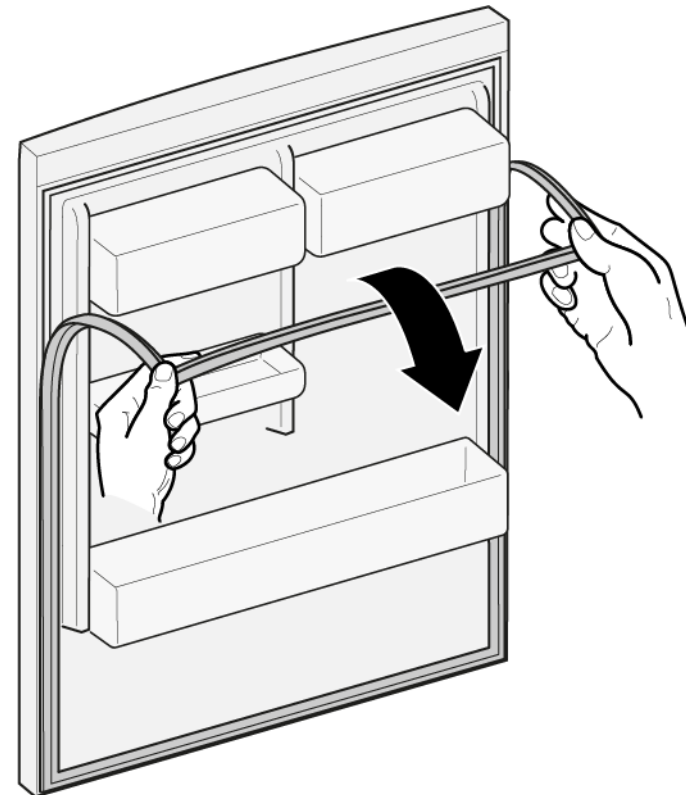

- ➡ A junta da porta está removida.

4.1.2 Instalar a junta da porta

	A espessura da nova junta da porta pode divergir ligeiramente da da junta antiga da porta. Isto não afetará o comportamento de fecho nem o funcionamento a longo termo.
	Se o seu aparelho dispor de dobradiças ou fixações de dobradiça ajustáveis, poderá otimizar o comportamento de fecho subsequentemente.
	Os pequenos orifícios laterais na junta da porta são funcionais (necessários à ventilação). Não se trata de falhas de produção.

Reparação

1. Verifique se a ranhura para a junta apresenta danos.

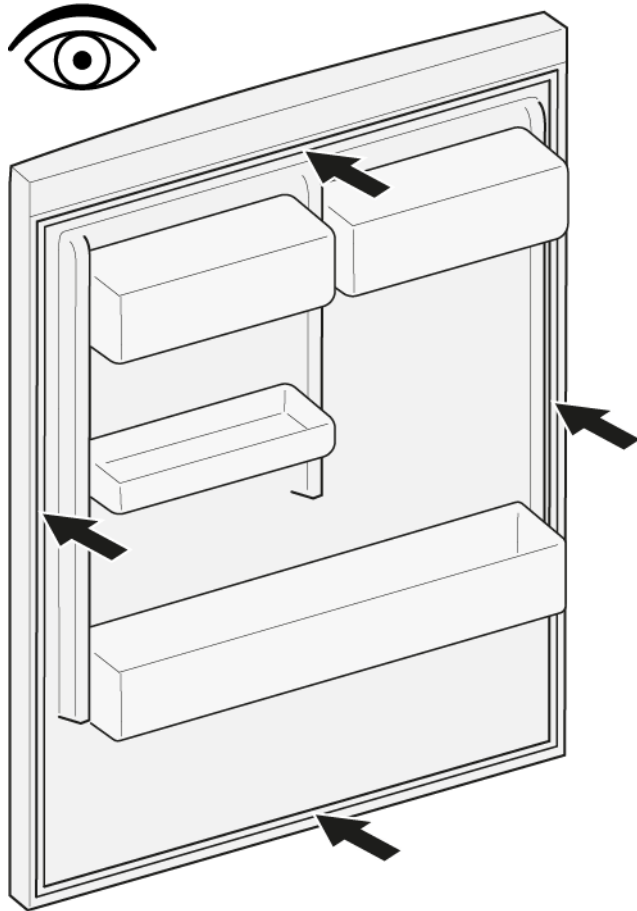

2.  Se a ranhura para a junta estiver danificada,
- contacte o serviço de apoio ao consumidor.

3.  Uma deformação ligeira da junta da porta é normal e não afeta o seu funcionamento. Recomenda-se que a junta da porta seja endireitada antes de ser inserida no aparelho.

Aqueça a junta da porta com a um secador de cabelo ou água quente e mude a sua forma manualmente.

4. Empurre os cantos da junta em cima e em baixo para ranhura.

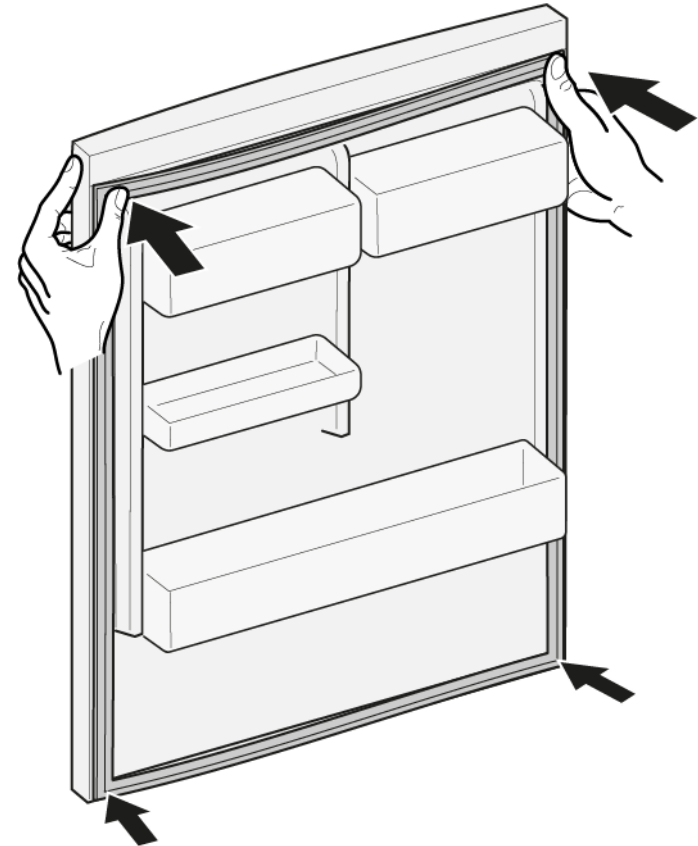

Reparação

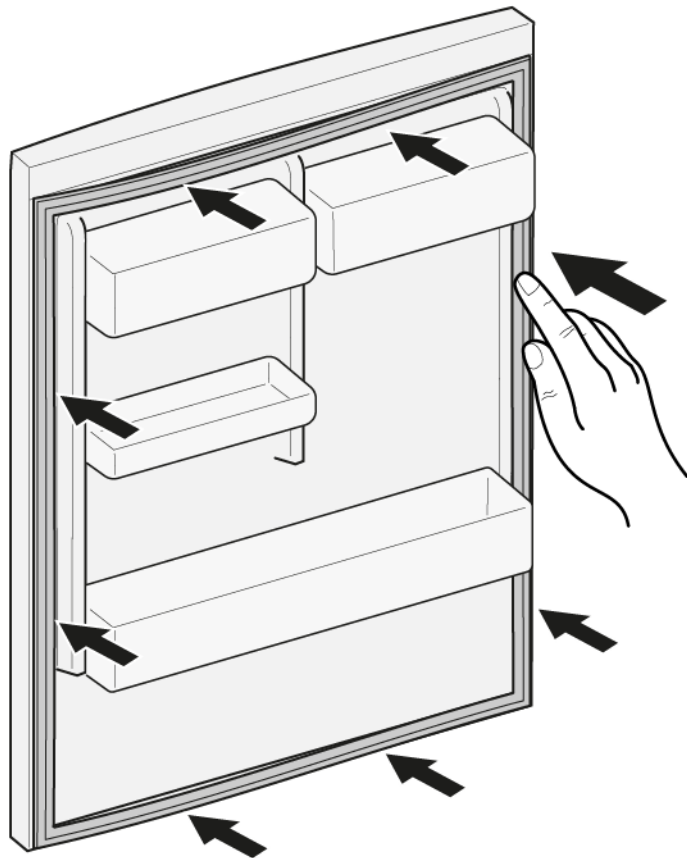

5. Pressione a junta inteira gradualmente para dentro da ranhura.





-  A junta da porta está instalada.

4.2 Substituir o puxador da porta

Ferramentas necessárias:

-  Ponta Torx TX20 6,3 mm (1/4") [00340865]
-  Chave de fendas Lâmina 10 mm x 1,6 mm x 200 mm

Pré-requisito:

-  O aparelho está desligado da alimentação elétrica.
-  A porta está aberta.

4.2.1 Remover o puxador da porta

- ▶ 1. Remova duas tampas roscadas (1).
- ▶ 2. Desaperte dois parafusos (2).
- ▶ 3. Remova o puxador da porta (3).

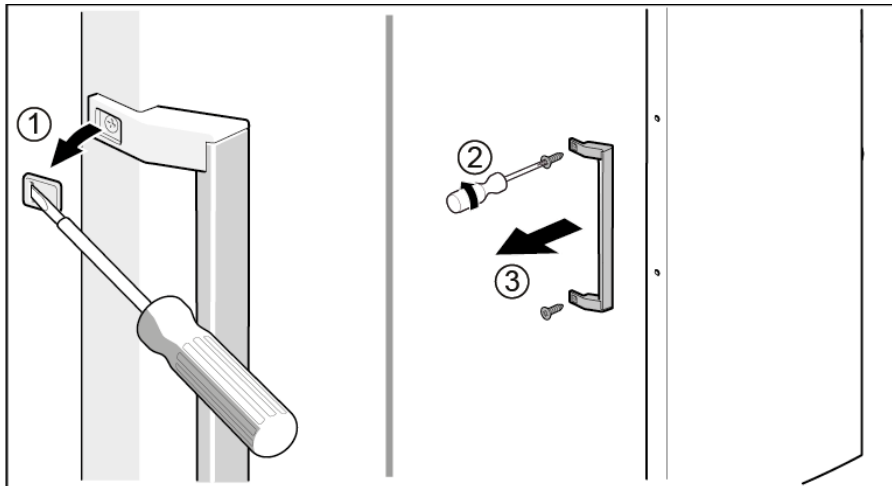

 O puxador da porta está removido.



O puxador da porta para a segunda porta pode ser removido da mesma forma.

4.2.2 Instalar o puxador da porta

- ▶ Instale pela ordem inversa.

4.3 Substituir a dobradiça superior da porta

Ferramentas necessárias:

 Ponta Torx TX20 6,3 mm (1/4") [00340865]

	AVISO Aparelhos pesados e volumosos! Lesões nas costas e musculares <ul style="list-style-type: none">▶ A operação de remoção da porta do aparelho deve ser apenas executada por especialistas formados.▶ São necessárias duas pessoas para mover o aparelho.▶ Use apenas ferramentas e equipamento adequados.
--	--



	CUIDADO Arestas vivas! Lesões por corte <ul style="list-style-type: none">▶ Use luvas de proteção.
--	--

	AVISO Deslizamento de aparelhos inclinados! Fraturas ósseas / ferimentos de esmagamento <ul style="list-style-type: none">▶ Proteja os aparelhos contra o deslizamento.
--	---

	CUIDADO Risco de queda de peças devido a parafusos desapertados! Lesões devido à queda de peças. <ul style="list-style-type: none">▶ Proteja o componente contra as quedas.
---	---

	ATENÇÃO! Risco de queda de peças devido a parafusos desapertados! Danos em outros componentes do aparelho ou na casa do cliente, p. ex., no pavimento. <ul style="list-style-type: none">▶ Proteja o componente contra as quedas.
--	---

Pré-requisito:

-  O aparelho está desligado da alimentação elétrica.
-  As fixações interiores do aparelho estão removidas.

4.3.1 Remover a dobradiça superior da porta

1. Coloque o aparelho sobre o lado traseiro.

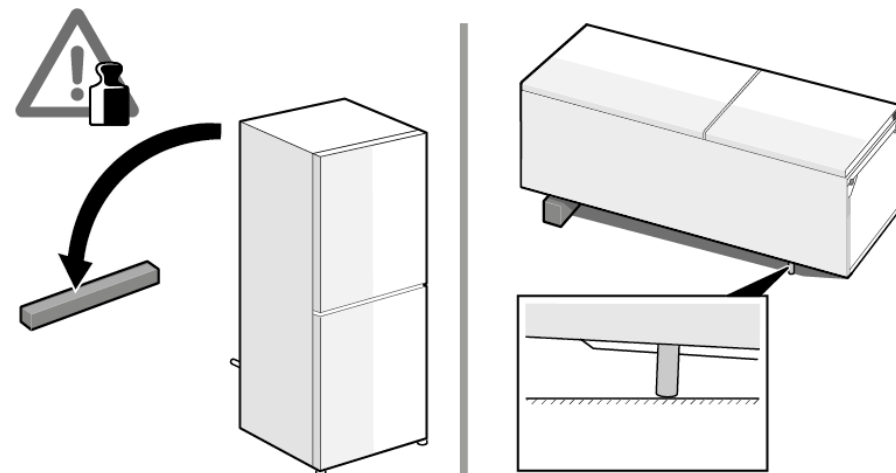

Reparação

2. 1. Pressione a tampa da dobradiça superior de ambos os lados (1).
2. Extraia a tampa da dobradiça superior (2).
3. Rode a tampa da dobradiça (3).
4. Remova a tampa da dobradiça superior (4).
5. Desaperte dois parafusos (5).
6. Remova a dobradiça superior (6).

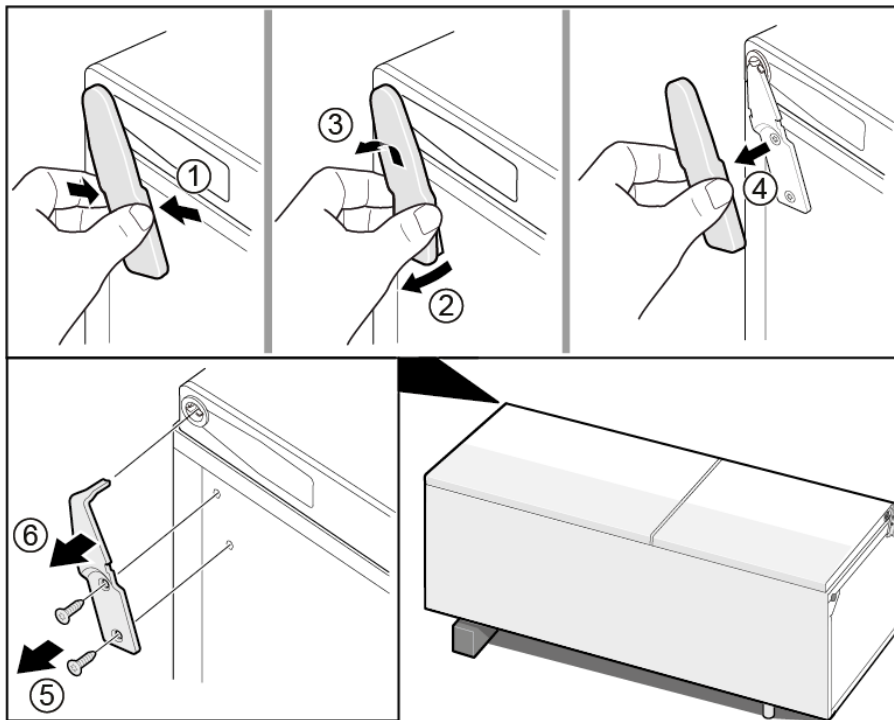

 A dobradiça superior está removida.

4.3.2 Instalar a dobradiça superior da porta

- ▶ Instale pela ordem inversa.

4.4 Substituir a dobradiça superior da porta (porta com visor)

Ferramentas necessárias:

🌀 Ponta Torx TX20 6,3 mm (1/4") [00340865]

	⚠️ AVISO
	<p>Aparelhos pesados e volumosos! Lesões nas costas e musculares</p> <ul style="list-style-type: none"> ▶ A operação de remoção da porta do aparelho deve ser apenas executada por especialistas formados. ▶ São necessárias duas pessoas para mover o aparelho. ▶ Use apenas ferramentas e equipamento adequados.

	⚠️ CUIDADO
	<p>Arestas vivas! Lesões por corte</p> <ul style="list-style-type: none"> ▶ Use luvas de proteção.

	⚠️ AVISO
	<p>Deslizamento de aparelhos inclinados! Fraturas ósseas / ferimentos de esmagamento</p> <ul style="list-style-type: none"> ▶ Proteja os aparelhos contra o deslizamento.

	⚠️ CUIDADO
	<p>Risco de queda de peças devido a parafusos desapertados! Lesões devido à queda de peças.</p> <ul style="list-style-type: none"> ▶ Proteja o componente contra as quedas.

	ATENÇÃO!
	<p>Risco de queda de peças devido a parafusos desapertados! Danos em outros componentes do aparelho ou na casa do cliente, p. ex., no pavimento.</p> <ul style="list-style-type: none"> ▶ Proteja o componente contra as quedas.

	⚠️ PERIGO
	<p>Risco de choque elétrico devido a partes sob tensão! Risco de vida devido a choque elétrico em caso de reparação inadequada</p> <ul style="list-style-type: none"> ▶ As partes elétricas devem ser reparadas por um electricista qualificado. ▶ Após a reparação, solicite a realização de um teste de segurança de acordo com VDE 0701 ou os regulamentos específicos do país.

	⚠️ PERIGO
	<p>Risco de choque elétrico devido a partes sob tensão! Morte por eletrocussão</p> <ul style="list-style-type: none"> ▶ Desligue os aparelhos da alimentação elétrica pelo menos 60 segundos antes de iniciar as reparações.

Pré-requisito:

- ✔ O aparelho está desligado da alimentação elétrica.
- ✔ As fixações interiores do aparelho estão removidas.

4.4.1 Remover a dobradiça superior da porta

1. Coloque o aparelho sobre o lado traseiro.

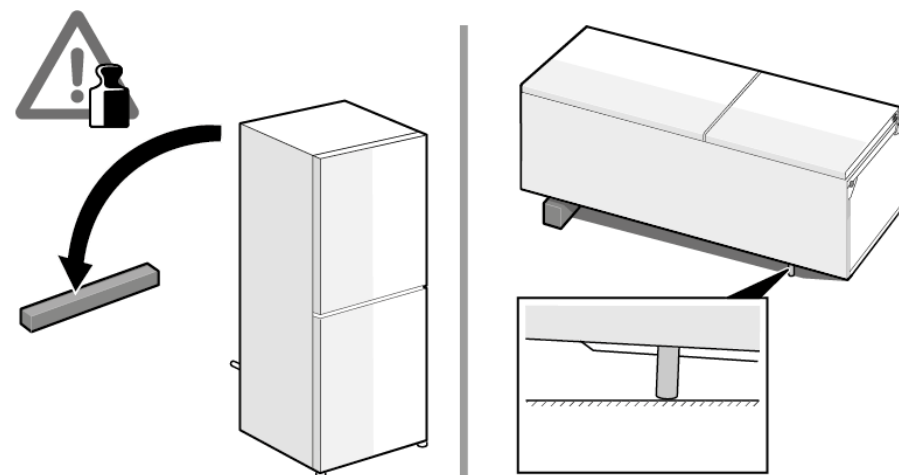

Reparação

2. 1. Remova a tampa da dobradiça superior (1).
2. Remova a tampa da caixa de cabos (2).
3. Desconecte a ligação elétrica (3).
4. Desaperte o parafuso de ligação à terra (4).
5. Remova a proteção dos cabos (5).
6. Desaperte o parafuso (6)

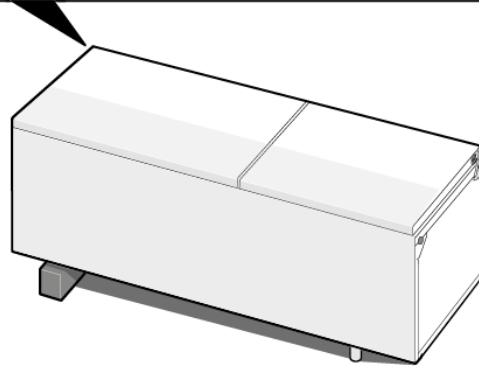
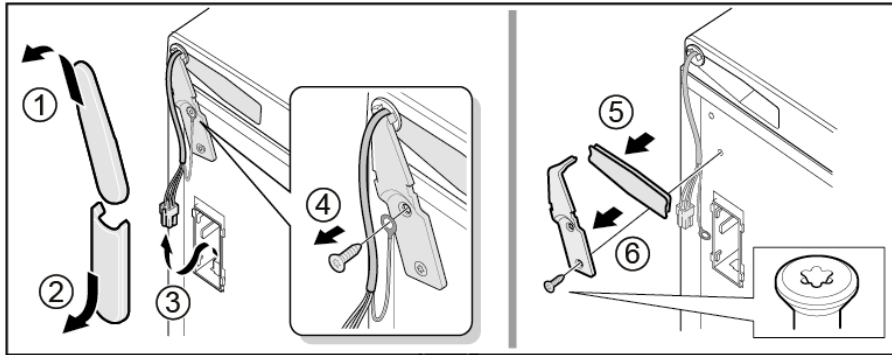

 A dobradiça superior está removida.

4.4.2 Instalar a dobradiça superior da porta

- ▶ Instale pela ordem inversa.

4.5 Substituir a dobradiça central da porta

Ferramentas necessárias:

🔧 Ponta Torx TX20 6,3 mm (1/4") [00340865]

	⚠️ AVISO
	Aparelhos pesados e volumosos! Lesões nas costas e musculares <ul style="list-style-type: none">▶ A operação de remoção da porta do aparelho deve ser apenas executada por especialistas formados.▶ São necessárias duas pessoas para mover o aparelho.▶ Use apenas ferramentas e equipamento adequados.

	⚠️ CUIDADO
	Arestas vivas! Lesões por corte <ul style="list-style-type: none">▶ Use luvas de proteção.

	⚠️ AVISO
	Deslizamento de aparelhos inclinados! Fraturas ósseas / ferimentos de esmagamento <ul style="list-style-type: none">▶ Proteja os aparelhos contra o deslizamento.

	⚠️ CUIDADO
	Risco de queda de peças devido a parafusos desapertados! Lesões devido à queda de peças. <ul style="list-style-type: none">▶ Proteja o componente contra as quedas.

	ATENÇÃO!
	Risco de queda de peças devido a parafusos desapertados! Danos em outros componentes do aparelho ou na casa do cliente, p. ex., no pavimento. <ul style="list-style-type: none">▶ Proteja o componente contra as quedas.

Pré-requisito:

- ✔ O aparelho está desligado da alimentação elétrica.
- ✔ As fixações interiores do aparelho estão removidas.
- ✔ A dobradiça superior da porta está removida.

4.5.1 Remover a dobradiça central da porta

- ▶ 1. Remova a porta do compartimento de refrigeração (1).
- ▶ 2. Desaperte dois parafusos (2).
- ▶ 3. Remova a dobradiça central (3).

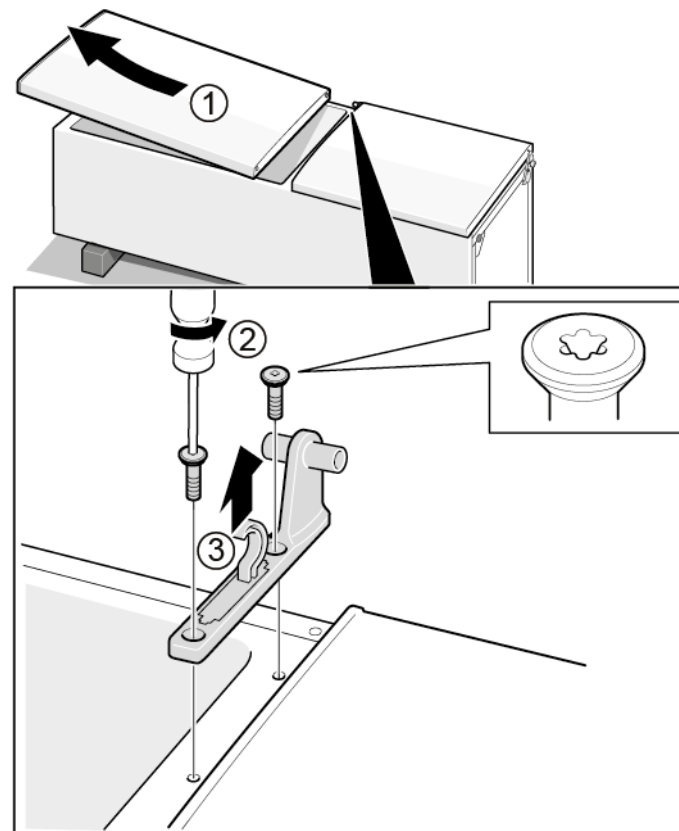

➡ A dobradiça central está removida.

4.5.2 Instalar a dobradiça central da porta

- ▶ Instale pela ordem inversa.

4.6 Substituir a dobradiça inferior da porta

Ferramentas necessárias:

🔧 Ponta Torx TX20 6,3 mm (1/4") [00340865]

	⚠️ AVISO
	Aparelhos pesados e volumosos! Lesões nas costas e musculares <ul style="list-style-type: none">▶ A operação de remoção da porta do aparelho deve ser apenas executada por especialistas formados.▶ São necessárias duas pessoas para mover o aparelho.▶ Use apenas ferramentas e equipamento adequados.

	⚠️ CUIDADO
	Arestas vivas! Lesões por corte <ul style="list-style-type: none">▶ Use luvas de proteção.

	⚠️ AVISO
	Deslizamento de aparelhos inclinados! Fraturas ósseas / ferimentos de esmagamento <ul style="list-style-type: none">▶ Proteja os aparelhos contra o deslizamento.

	⚠️ CUIDADO
	Risco de queda de peças devido a parafusos desapertados! Lesões devido à queda de peças. <ul style="list-style-type: none">▶ Proteja o componente contra as quedas.

	ATENÇÃO!
	Risco de queda de peças devido a parafusos desapertados! Danos em outros componentes do aparelho ou na casa do cliente, p. ex., no pavimento. <ul style="list-style-type: none">▶ Proteja o componente contra as quedas.

Pré-requisito:

- ✔ O aparelho está desligado da alimentação elétrica.
- ✔ As fixações interiores do aparelho estão removidas.
- ✔ A dobradiça superior está removida.

✔ A dobradiça central está removida.

4.6.1 Remover a dobradiça inferior da porta

- ▶ 1. Remova a porta da zona do congelador (1).
- ▶ 2. Desaperte o parafuso (2).
- ▶ 3. Rode dobradiça inferior para fora (3).
- ▶ 4. Remova a dobradiça inferior (4).

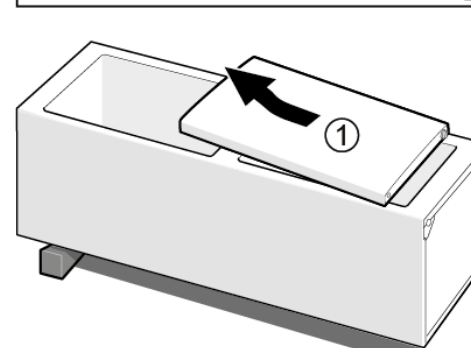
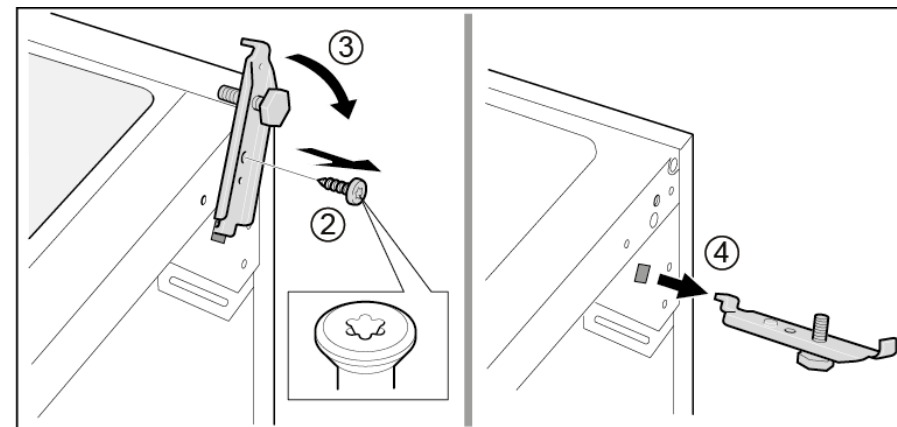

➡ A dobradiça inferior da porta está removida.

4.6.2 Instalar a dobradiça inferior da porta

- ▶ Instale pela ordem inversa.

4.7 Substituir a prateleira

Pré-requisito:

- ✔ A porta está aberta.

4.7.1 Remover a prateleira

- ▶ Puxe a prateleira para fora.

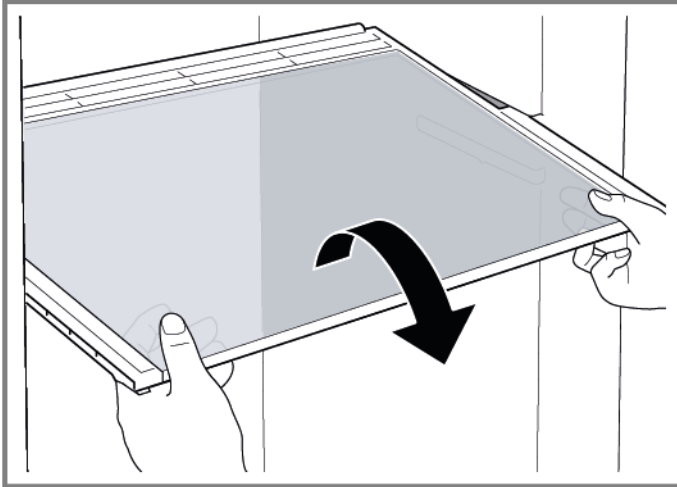

➡ A prateleira está removida.

4.7.2 Instalar a prateleira

- ▶ Instale pela ordem inversa.

4.8 Substituir o suporte para garrafas

Pré-requisito:

- ✔ A porta está aberta.

4.8.1 Remover o suporte para garrafas

- ▶ Puxe para fora o suporte para garrafas.

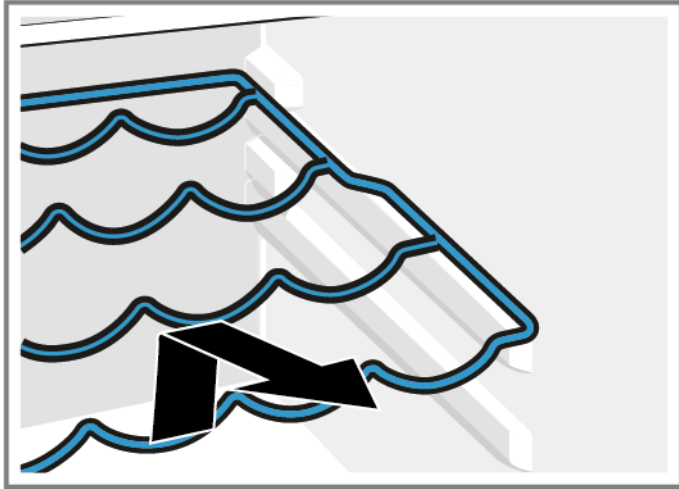

- ➡ O suporte para garrafas está removido.

4.8.2 Instalar o suporte para garrafas

- ▶ Instale pela ordem inversa.

4.9 Substituir a prateleira da porta

Pré-requisito:

- ✔ A porta está aberta.

4.9.1 Remover a prateleira da porta

- ▶ Levante a prateleira da porta.

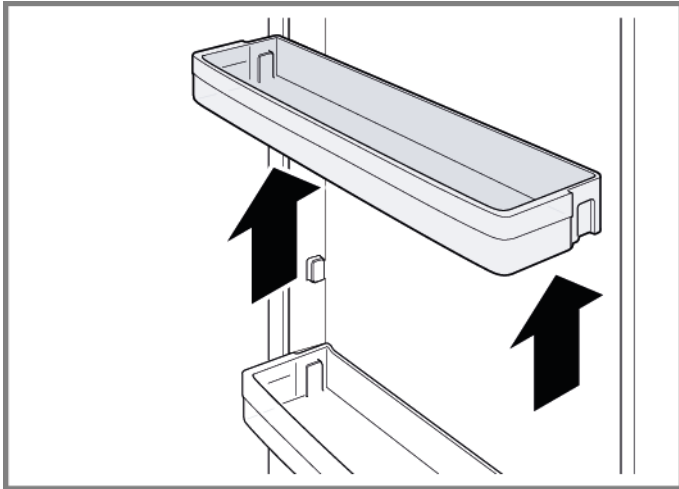

➡ A prateleira da porta está removida.

4.9.2 Instalar a prateleira da porta

- ▶ Instale pela ordem inversa.

4.10 Substituir a prateleira da porta ajustável

Pré-requisito:

- ✔ A porta está aberta.

4.10.1 Remover a prateleira da porta ajustável

- ▶ Levante a prateleira da porta ajustável em altura até esta se soltar do suporte.

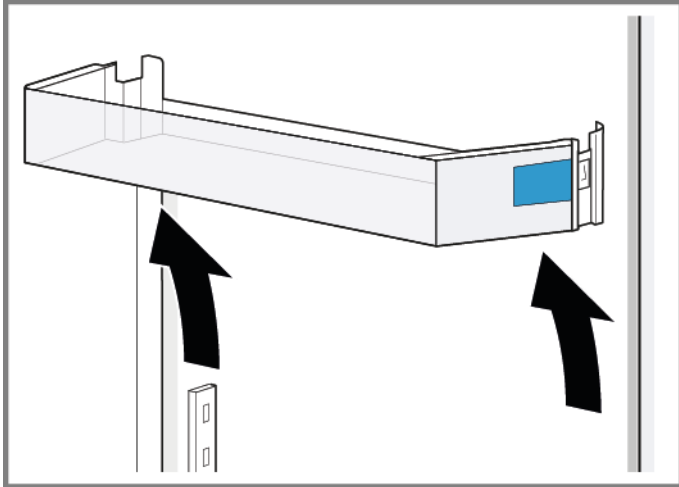

- ➡ A prateleira da porta ajustável está removida.

4.10.2 Instalar a prateleira da porta ajustável

- ▶ Instale pela ordem inversa.

4.11 Substituir o recipiente para alimentos congelados

Pré-requisito:

- ✔ A porta está aberta.

4.11.1 Remover o recipiente para alimentos congelados

- ▶ 1. Puxe o recipiente para alimentos congelados inteiramente para fora (1).
- ▶ 2. Remova o recipiente para alimentos (2).

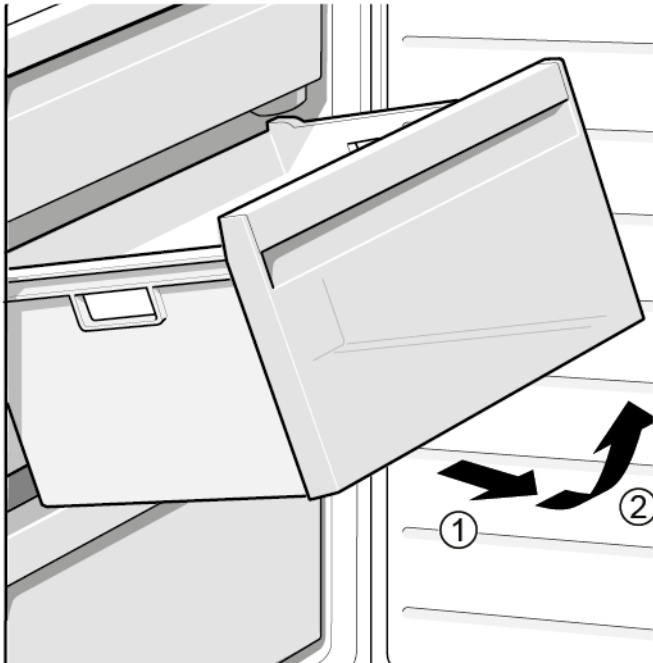

- ➡ O recipiente para alimentos congelados está removido.

4.11.2 Instalar o recipiente para alimentos congelados

- ▶ Instale pela ordem inversa.

4.12 Substituir o recipiente

Pré-requisito:

- ✔ A porta está aberta.

4.12.1 Remover o recipiente

- ▶ 1. Retire o recipiente inferior do frigorífico (1).
- ▶ 2. Retire o recipiente superior do frigorífico (2).

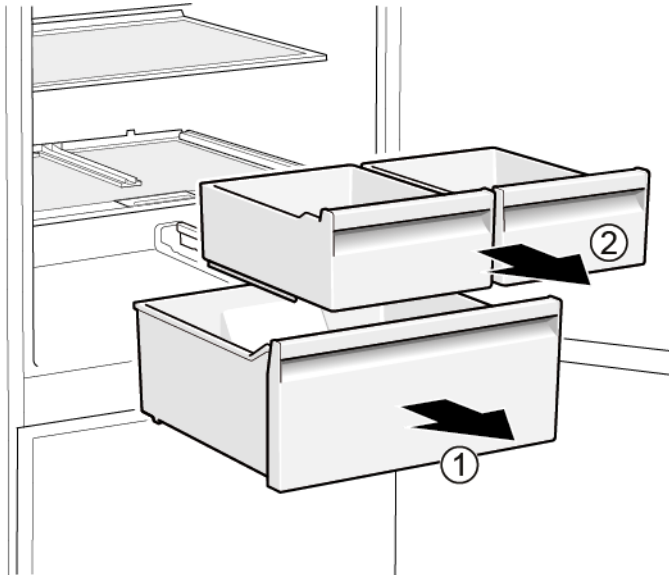

- ➡ Os recipientes estão removidos.

4.12.2 Instalar o recipiente

- ▶ Instale pela ordem inversa.

4.13 Substituir o recipiente extensível

Pré-requisito:

- ✔ A porta está aberta.

4.13.1 Remover o recipiente extensível

- ▶ 1. Puxe o recipiente extensível inteiramente para fora (1).
- ▶ 2. Remova o recipiente extensível (2).

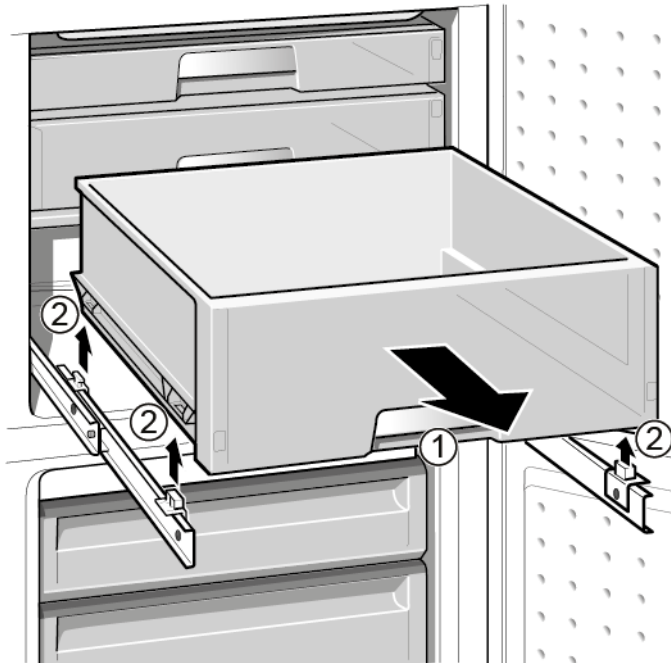

- ➡ O recipiente extensível está removido.

4.13.2 Instalar o recipiente extensível

- ▶ Instale pela ordem inversa.

4.14 Substituir a iluminação LED específica

Ferramentas necessárias:

 Ferramenta especial

[00342180]



O seu aparelho dispõe de uma iluminação LED isenta de manutenção. Estas iluminações só podem ser reparadas pelo serviço de apoio ao consumidor ou por técnicos autorizados!



PERIGO

Risco de choque elétrico devido a partes sob tensão!

Risco de vida devido a choque elétrico em caso de reparação inadequada

- ▶ As partes elétricas devem ser reparadas por um electricista qualificado.
- ▶ Após a reparação, solicite a realização de um teste de segurança de acordo com VDE 0701 ou os regulamentos específicos do país.



PERIGO

Risco de choque elétrico devido a partes sob tensão!

Morte por eletrocussão

- ▶ Desligue os aparelhos da alimentação elétrica pelo menos 60 segundos antes de iniciar as reparações.





CUIDADO

Arestas vivas!

Lesões por corte

- ▶ Use luvas de proteção.

Pré-requisito:

-  O aparelho está desligado da alimentação elétrica.
-  A porta está aberta.

4.14.1 Remover a iluminação LED específica

1. Use uma ferramenta especial para puxar para fora a iluminação LED específica (1).

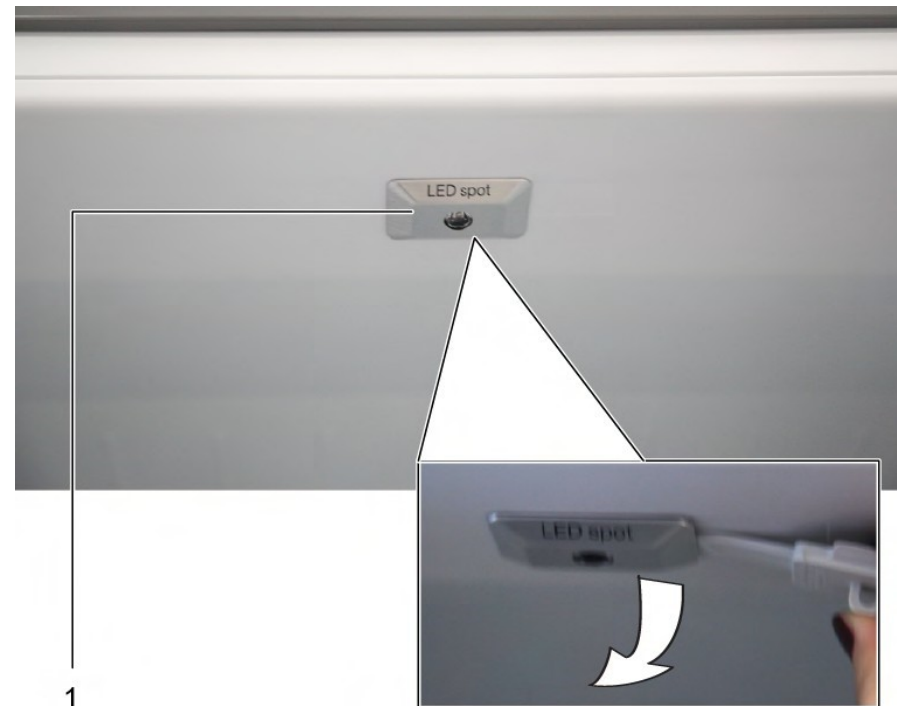

2. Desconecte as ligações elétricas da iluminação LED específica.
-  A iluminação LED específica está removida.

4.14.2 Instalar a iluminação LED específica

- ▶ Instale pela ordem inversa.

4.15 Substituir a iluminação LED superior

Ferramentas necessárias:

-  Chave de fendas Lâmina 2,4 mm x 0,4 mm x 60 mm, no kit [00341820]



O seu aparelho dispõe de uma iluminação LED isenta de manutenção. Estas iluminações só podem ser reparadas pelo serviço de apoio ao consumidor ou por técnicos autorizados!



PERIGO

Risco de choque elétrico devido a partes sob tensão!

Risco de vida devido a choque elétrico em caso de reparação inadequada

- ▶ As partes elétricas devem ser reparadas por um electricista qualificado.
- ▶ Após a reparação, solicite a realização de um teste de segurança de acordo com VDE 0701 ou os regulamentos específicos do país.



PERIGO

Risco de choque elétrico devido a partes sob tensão!

Morte por eletrocussão

- ▶ Desligue os aparelhos da alimentação elétrica pelo menos 60 segundos antes de iniciar as reparações.





CUIDADO

Arestas vivas!

Lesões por corte

- ▶ Use luvas de proteção.

Pré-requisito:

-  O aparelho está desligado da alimentação elétrica.
-  A porta está aberta.
-  As fixações interiores superiores estão removidas.

4.15.1 Remover a iluminação LED

1. Desloque a iluminação LED para o lado esquerdo.

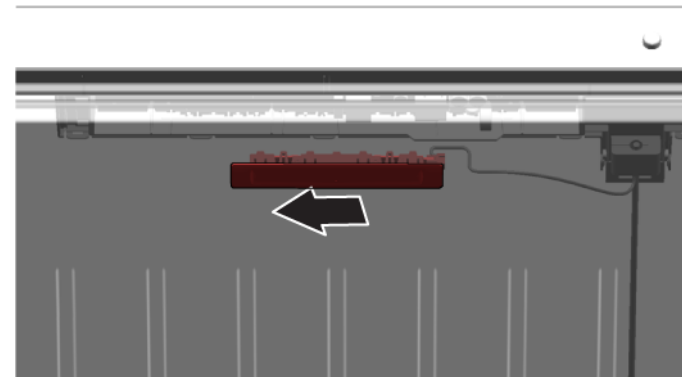

-  A ligação elétrica da iluminação LED está desligada.

2. Solte os ganchos da iluminação LED.

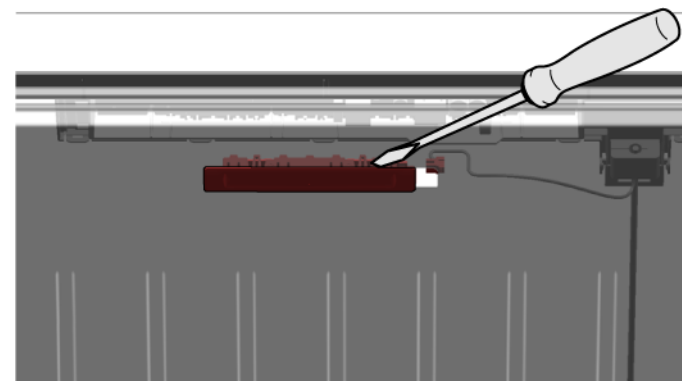

Reparação

3. Remova a iluminação LED, avançando-a.

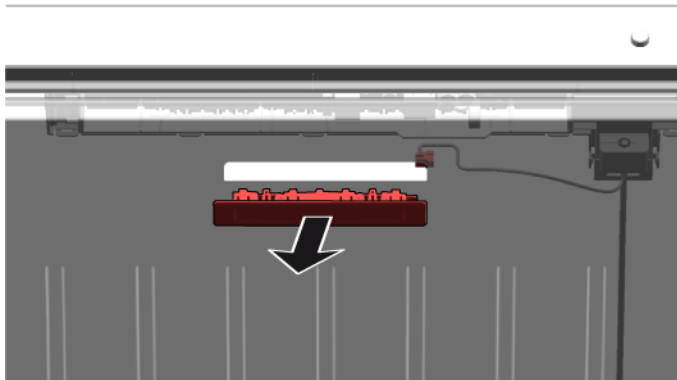

-  A iluminação LED está removida.

4.15.2 Instalar a iluminação LED superior

- ▶ Instale pela ordem inversa.

4.16 Substituir a iluminação LED de barra lateral

Ferramentas necessárias:

 Ventosa Ø50 mm [00342224]



O seu aparelho dispõe de uma iluminação LED isenta de manutenção. Estas iluminações só podem ser reparadas pelo serviço de apoio ao consumidor ou por técnicos autorizados!



PERIGO

Risco de choque elétrico devido a partes sob tensão!
Risco de vida devido a choque elétrico em caso de reparação inadequada

- ▶ As partes elétricas devem ser reparadas por um electricista qualificado.
- ▶ Após a reparação, solicite a realização de um teste de segurança de acordo com VDE 0701 ou os regulamentos específicos do país.



PERIGO

Risco de choque elétrico devido a partes sob tensão!
Morte por eletrocussão

- ▶ Desligue os aparelhos da alimentação elétrica pelo menos 60 segundos antes de iniciar as reparações.





CUIDADO

Arestas vivas!

Lesões por corte

- ▶ Use luvas de proteção.

Pré-requisito:

-  O aparelho está desligado da alimentação elétrica.
-  A porta está aberta.
-  As prateleiras do compartimento de refrigeração estão removidas.

4.16.1 Remover a iluminação LED de barra lateral

1. Coloque a ventosa no terço superior da iluminação LED de barra lateral.



Reparação

2. Puxe a ventosa para a frente com a iluminação LED de barra lateral num movimento rotativo.

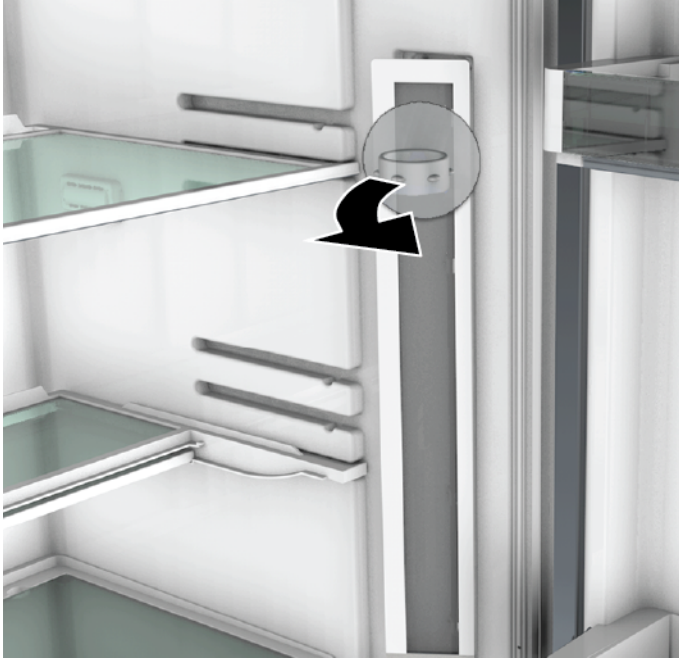

3. Desconecte a ligação elétrica da iluminação LED de barra lateral.
➡ A iluminação LED de barra lateral está removida.



4.16.2 Instalar a iluminação LED de barra lateral

1. Conecte a ligação elétrica da iluminação LED de barra lateral.
2. Fixe a iluminação LED de barra lateral na sua localização na parede do compartimento (os ganchos encaixam).

- ➡ A iluminação LED de barra lateral está instalada.

4.17 Substituir a iluminação LED específica

Ferramentas necessárias:

-  Ferramenta especial [00342180]
-  Chave de fendas Lâmina 2,4 mm x 0,4 mm x 60 mm, no kit [00341820]



O seu aparelho dispõe de uma iluminação LED isenta de manutenção. Estas iluminações só podem ser reparadas pelo serviço de apoio ao consumidor ou por técnicos autorizados!



PERIGO

Risco de choque elétrico devido a partes sob tensão!

Risco de vida devido a choque elétrico em caso de reparação inadequada

- ▶ As partes elétricas devem ser reparadas por um electricista qualificado.
- ▶ Após a reparação, solicite a realização de um teste de segurança de acordo com VDE 0701 ou os regulamentos específicos do país.



PERIGO

Risco de choque elétrico devido a partes sob tensão!

Morte por eletrocussão

- ▶ Desligue os aparelhos da alimentação elétrica pelo menos 60 segundos antes de iniciar as reparações.





CUIDADO

Arestas vivas!

Lesões por corte

- ▶ Use luvas de proteção.

Pré-requisito:

-  O aparelho está desligado da alimentação elétrica.
-  A porta está aberta.
-  As prateleiras do compartimento de refrigeração estão removidas.

4.17.1 Remover a iluminação LED específica

1. Solte a tampa da iluminação LED específica.

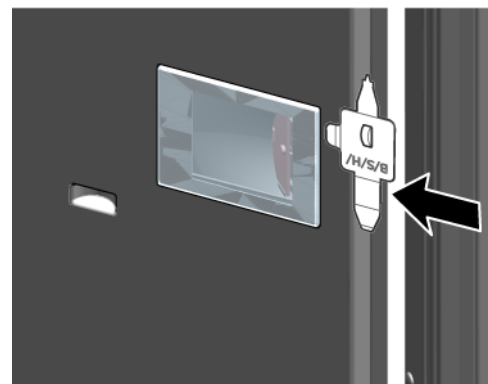

2. Puxe a tampa da iluminação LED específica para dentro, empurrando para a frente em simultâneo.

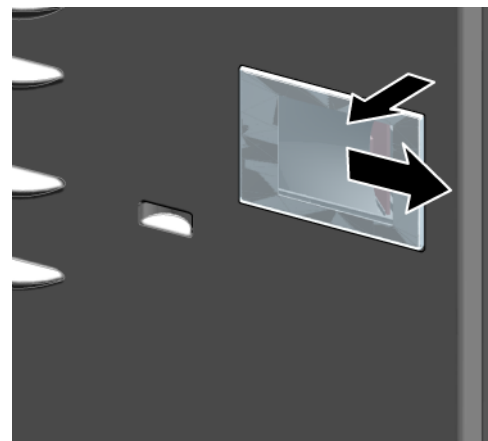

Reparação

3. Desprenda o módulo da iluminação LED específica.

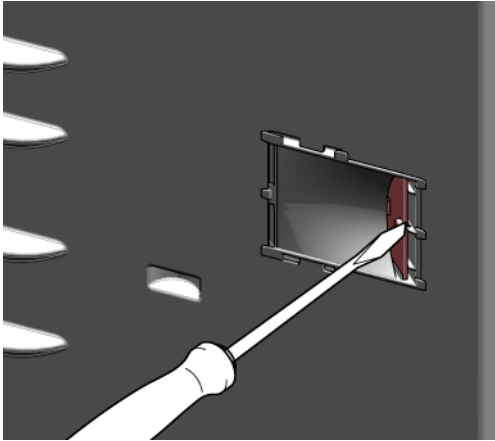

4. Desconecte a ligação elétrica da iluminação LED específica.

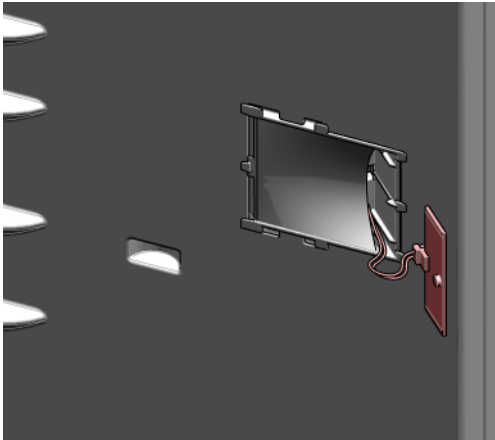

-  A iluminação LED específica está removida.

4.17.2 Instalar a iluminação LED específica

- ▶ Instale pela ordem inversa.

Indicii pentru reparații - Combinație aparat de răcire/congelare

 Referitor la acest document	525
1.1 Informații importante	525
1.1.1 Aplicabilitatea	525
1.2 Explicația simbolurilor	525
1.2.1 Nivelurile de pericol	525
1.2.2 Simbolurile de pericol	525
1.2.3 Structura avertismentelor	526
1.2.4 Simbolurile generale	526
 Siguranța	527
2.1 Instrucțiuni generale de siguranță	527
2.1.1 Toate aparatele electrocasnice	527
 Instrumente și materiale utile	528
 Repararea	529
4.1 Înlocuirea garniturii ușii	529
4.1.1 Demontarea garniturii ușii	529
4.1.2 Montarea garniturii ușii	529
4.2 Înlocuirea mânerului ușii	532
4.2.1 Demontarea mânerului ușii	532
4.2.2 Montarea mânerului ușii	532
4.3 Înlocuirea balamalei de sus a ușii	533
4.3.1 Demontarea balamalei de sus a ușii	533
4.3.2 Montarea balamalei de sus a ușii	534
4.4 Înlocuirea balamalei de sus a ușii (ușă cu afișaj)	535
4.4.1 Demontarea balamalei de sus a ușii	535
4.4.2 Montarea balamalei de sus a ușii	536
4.5 Înlocuirea balamalei din mijloc a ușii	537
4.5.1 Demontarea balamalei din mijloc a ușii	537
4.5.2 Montarea balamalei din mijloc a ușii	537
4.6 Înlocuirea balamalei de jos a ușii	538
4.6.1 Demontarea balamalei de jos a ușii	538
4.6.2 Montarea balamalei de jos a ușii	538
4.7 Repoziționarea raftului	539
4.7.1 Demontarea raftului	539
4.7.2 Montarea raftului	539

4.8 Repoziționarea suportului pentru sticle	540
4.8.1 Demontarea suportului pentru sticle	540
4.8.2 Montarea suportului pentru sticle	540
4.9 Repoziționarea raftului pentru ușă	541
4.9.1 Demontarea raftului pentru ușă	541
4.9.2 Montarea raftului pentru ușă	541
4.10 Repoziționarea raftului pentru ușă reglabil	542
4.10.1 Demontarea raftului pentru ușă reglabil	542
4.10.2 Montarea raftului pentru ușă reglabil	542
4.11 Repoziționarea containerului pentru alimente înghețate	543
4.11.1 Demontarea containerului pentru alimente înghețate	543
4.11.2 Montarea containerului pentru alimente înghețate	543
4.12 Repoziționarea containerului	544
4.12.1 Demontarea containerului	544
4.12.2 Montarea containerului	544
4.13 Repoziționarea containerului extensibil	545
4.13.1 Demontarea containerului extensibil	545
4.13.2 Montarea containerului extensibil	545
4.14 Înlocuirea spotului luminos LED	546
4.14.1 Demontarea spotului luminos LED	546
4.14.2 Montarea spotului luminos LED	546
4.15 Înlocuirea lămpii LED de sus	547
4.15.1 Demontarea lămpii LED	547
4.15.2 Montarea lămpii LED de sus	548
4.16 Înlocuirea lămpii LED de pe bara laterală	549
4.16.1 Demontarea lămpii LED de pe bara laterală	549
4.16.2 Montarea lămpii LED de pe bara laterală	550
4.17 Înlocuirea spotului luminos LED	551
4.17.1 Demontarea spotului luminos LED	551
4.17.2 Montarea spotului luminos LED	552

i Referitor la acest document

1.1 Informații importante

1.1.1 Aplicabilitatea

Aceste instrucțiuni de reparare îl ajută pe client să își repare singur aparatele, în conformitate cu normele de proiectare ecologică aplicabile (începând cu 03/2021).



Acestea conțin informații privind modul de înlocuire a pieselor de schimb specifice, inclusiv avertismente și pericole.

Dacă aveți întrebări, vă rugăm să luați legătura cu serviciul relații clienți. Ne asumăm răspunderea pentru daune numai dacă instrucțiunile de reparare au fost respectate pe deplin.

1.2 Explicația simbolurilor

1.2.1 Nivelurile de pericol

Nivelurile de alertă sunt reprezentate printr-un simbol și un cuvânt de avertizare. Cuvântul de avertizare indică gravitatea pericolului.





Nivelul de alertă	Semnificație
 PERICOL	Nerespectarea mesajului de avertizare va provoca accidente grave sau decesul.
 AVERTISMENT	Nerespectarea mesajului de avertizare ar putea provoca accidente grave sau decesul.
 ATENȚIONARE	Nerespectarea mesajului de avertizare ar putea provoca accidente ușoare.
ATENȚIE!	Nerespectarea mesajului de avertizare ar putea provoca daune asupra proprietății.

Tabel 1: Nivelurile de pericol



1.2.2 Simbolurile de pericol

Simbolurile de pericol sunt reprezentări simbolice care indică tipul de pericol.

În acest document sunt utilizate simbolurile de pericol de mai jos:

Simbol de pericol	Semnificație
	Mesaj de avertizare general
	Pericol din cauza tensiunii electrice
	Pericol de explozie
	Pericol de tăiere
	Pericol de zdrobire

Referitor la acest document

Simbol de pericol	Semnificație
	Pericol din cauza suprafețelor fierbinți
	Pericol din cauza câmpului magnetic puternic
	Pericol din cauza radiației neionizante

Tabel 2: Simbolurile de pericol

1.2.3 Structura avertismentelor

Avertismentele din acest document au un aspect și o structură standard.



	<div style="background-color: red; color: white; padding: 2px; text-align: center;"> PERICOL</div> <p>Tipul și sursa pericolului! Consecințele posibile ale ignorării pericolului/avertismentului.</p> <ul style="list-style-type: none"> ▶ Măsuri și interdicții pentru prevenirea pericolului.
--	--





Exemplul următor prezintă un avertisment privind electrocutarea din cauza pieselor sub tensiune. Se menționează măsura necesară pentru a evita pericolul.

	<div style="background-color: red; color: white; padding: 2px; text-align: center;"> PERICOL</div> <p>Pericol de electrocutare din cauza pieselor sub tensiune! Deces prin electrocutare</p> <ul style="list-style-type: none"> ▶ Deconectați aparatele de la sursa de alimentare cu tensiune cu cel puțin 60 de secunde înainte de a începe reparațiile.
---	---

1.2.4 Simbolurile generale

În acest document sunt utilizate simbolurile generale de mai jos:

Simbol general	Semnificație
	Identificarea unei recomandări speciale (text și/sau grafică)
	Identificarea unei recomandări simple (numai text)

Simbol general	Semnificație
	Identificarea unui link spre un videoclip instructiv
	Identificarea sculelor necesare
	Identificarea condițiilor preliminare necesare
	Identificarea unei stări (dacă..., apoi...)
	Identificarea unui rezultat
[Pornire]	Identificarea unei taste sau a unui buton
[00123456]	Identificarea unui număr de serie
Stare	Identificarea unui text/unei ferestre afișate (pe ecranul aparatului)

Tabel 3: Simbolurile generale

2.1 Instrucțiuni generale de siguranță

2.1.1 Toate aparatele electrocasnice

Pericol de electrocutare din cauza pieselor sub tensiune!

- Erorile care au loc în timpul reparațiilor efectuate la componentele electrice pot să ducă la electrocutări!
- Deconectați aparatul de la sursa de alimentare cu tensiune cu cel puțin 60 de secunde înainte de a începe lucrările.
- După reparație, este obligatorie efectuarea unei verificări de siguranță conform cu VDE 0701 sau cu reglementările naționale respective.

Pericol de rănire din cauza muchiilor ascuțite!

- Purtați mănuși de protecție.

Pericol de zdrobire în timpul lucrărilor de reparație, întreținere, depanare și service, din cauza componentelor grele și mobile

- Purtați încălțăminte de protecție.
- Fixați componentele grele împotriva căderii.
- Nu vă sprijiniți cu părți ale corpului de componentele mobile.





Pericol pentru siguranța/funcționarea aparatului!

- Utilizați numai piese de schimb originale.

Pericol de deteriorare a componentelor sensibile la electricitatea statică (ESD)!

- Nu atingeți modulele, inclusiv conexiunile și căile conductorilor.

Instrumente și materiale utile

Desemnare	Detalii	Imagini
Material textil de protecție [00342013]	60 cm x 50 cm	
Șurubelniță plată	Lamă de 2,4 mm x 0,4 mm x 60 mm, în kitul [00341820]	
Instrument special [00342180]		
Ventuză [00342224]	Ø50 mm	
Cap torx TX20 [00340865]	6,3 mm (1/4")	
Șurubelniță plată	Lamă de 10 mm x 1,6 mm x 200 mm	

4.1 Înlocuirea garniturii ușii

Cerință:

- ✓ Ușa este deschisă.

4.1.1 Demontarea garniturii ușii

1. Îndepărtați garnitura ușii din canelura colțurilor din dreapta și stânga.





2. Demontați garnitura ușii din canelură.



- ➡ Garnitura ușii este demontată.

4.1.2 Montarea garniturii ușii

	Grosimea garniturii noi a ușii poate fi ușor diferită față de grosimea garniturii vechi a ușii. Acest lucru nu va afecta comportamentul de închidere și funcționarea pe termen lung.
	Dacă aparatul dumneavoastră are balamale reglabile sau accesorii pentru balamale, puteți optimiza comportamentul de închidere în consecință.
	Orificiile de mici dimensiuni practicate în garnitura ușii au rol funcțional (sunt necesare pentru ventilație). Ele nu sunt defecte ale produsului.

Repararea

1. Verificați canelura pentru montarea garniturii și asigurați-vă că nu prezintă defecte.

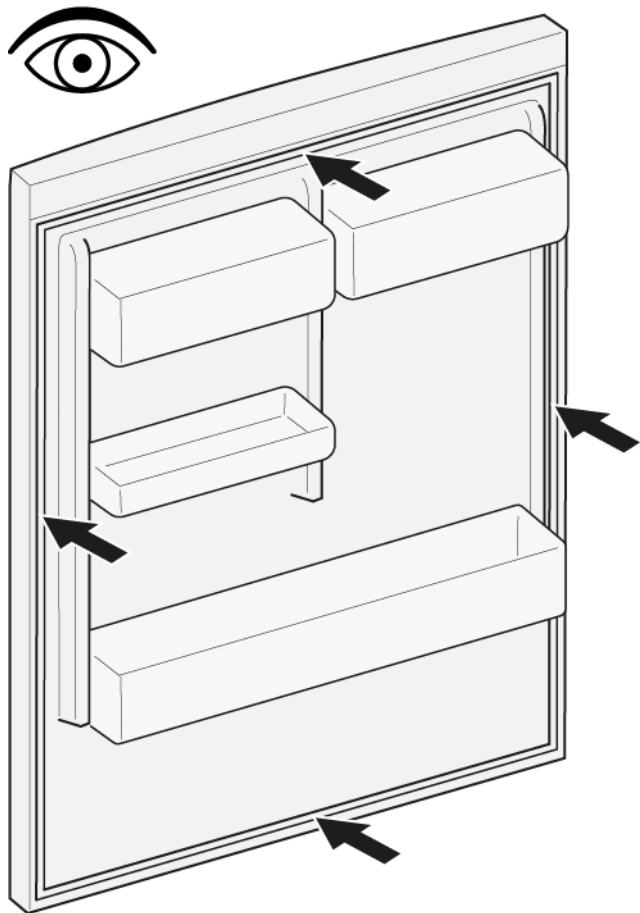

4. Împingeți colțurile de sus și de jos ale garniturii în canelură.

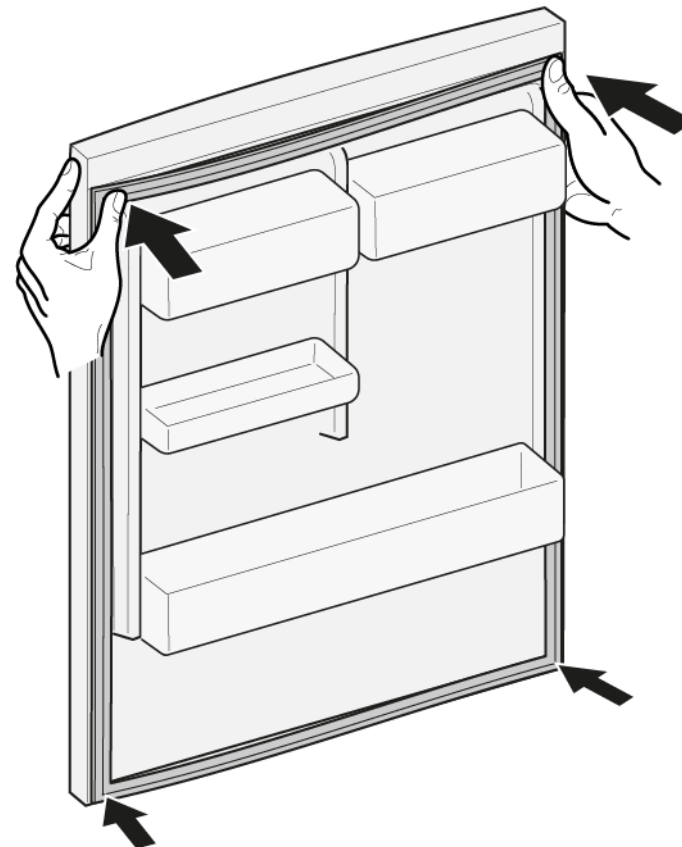

2.  Dacă canelura pentru montarea garniturii prezintă defecte, este deteriorată.
- Contactați departamentul de service pentru clienți.

3.  O deformare ușoară a garniturii ușii este normală și nu afectează funcționarea acesteia. Se recomandă să îndreptați garnitura ușii înainte de a o introduce în aparat.

Încălziți garnitura ușii cu un uscător de păr sau cu apă fierbinte și remodelați-o cu mâna.

Repararea



5. Apăsați întreaga garnitură în canelură, pas cu pas.





 Garnitura ușii este montată.

4.2 Înlocuirea mânerului ușii

Scule speciale:

-  Cap torx TX20 6,3 mm (1/4") [00340865]
-  Șurubelniță plată Lamă de 10 mm x 1,6 mm x 200 mm

Cerință:

-  Aparatul este deconectat de la sursa de energie electrică.
-  Ușa este deschisă.

4.2.1 Demontarea mânerului ușii

- ▶ 1. Demontați două capace de șuruburi (1).
- ▶ 2. Deșurubați două șuruburi (2).
- ▶ 3. Demontați mânerul ușii (3).

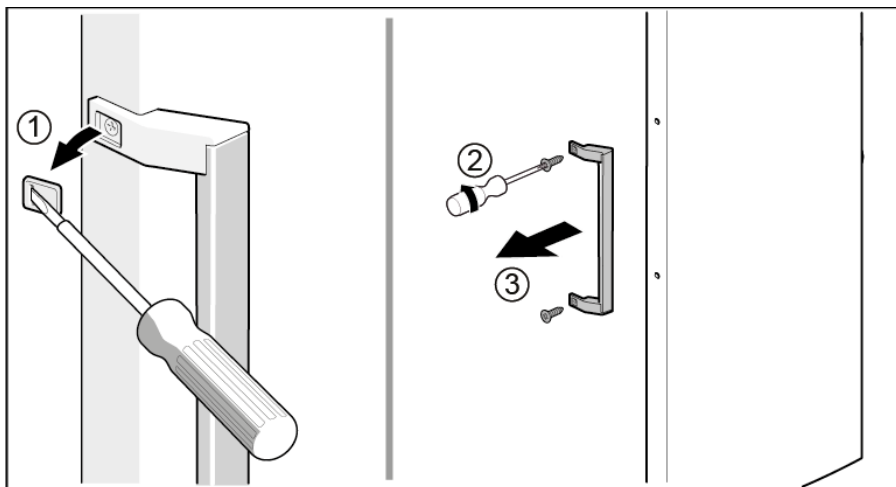

 Mânerul ușii este demontat.



Mânerul ușii pentru cea de-a doua ușă poate fi demontat în același mod.

4.2.2 Montarea mânerului ușii

- ▶ Montați urmând procedura de demontare în ordine inversă.

4.3 Înlocuirea balamalei de sus a ușii

Scule speciale:

🌀 Cap torx TX20

6,3 mm (1/4")

[00340865]

	⚠️ AVERTISMENT
	Aparate grele, masive! Accidentarea spatelui și leziuni musculare <ul style="list-style-type: none">▶ Operația de demontare a ușii aparatului trebuie efectuată numai de specialiști instruiți.▶ Pentru deplasarea aparatului sunt necesare două persoane.▶ Utilizați numai instrumente și echipamente adecvate.

	⚠️ ATENȚIONARE
	Marginea ascuțită! Rănire prin tăiere <ul style="list-style-type: none">▶ Purtați mănuși de protecție.

	⚠️ AVERTISMENT
	Alunecarea aparatelor înclinate! Fracturi/zdrobiri <ul style="list-style-type: none">▶ Fixați aparatele împotriva alunecării.

	⚠️ ATENȚIONARE
	Pericol din cauza pieselor care cad pentru că șuruburile sunt slăbite! Accidente din cauza pieselor care cad. <ul style="list-style-type: none">▶ Fixați componenta împotriva căderii.

	ATENȚIE!
	Pericol din cauza pieselor care cad pentru că șuruburile sunt slăbite! Deteriorarea altor piese ale aparatului sau a casei clientului, de exemplu, partea de jos. <ul style="list-style-type: none">▶ Fixați componenta împotriva căderii.

Cerință:

- ✔️ Aparatul este deconectat de la sursa de energie electrică.
- ✔️ Fitingurile interioare ale aparatului sunt demontate.

4.3.1 Demontarea balamalei de sus a ușii

1. Așezați aparatul pe spate.

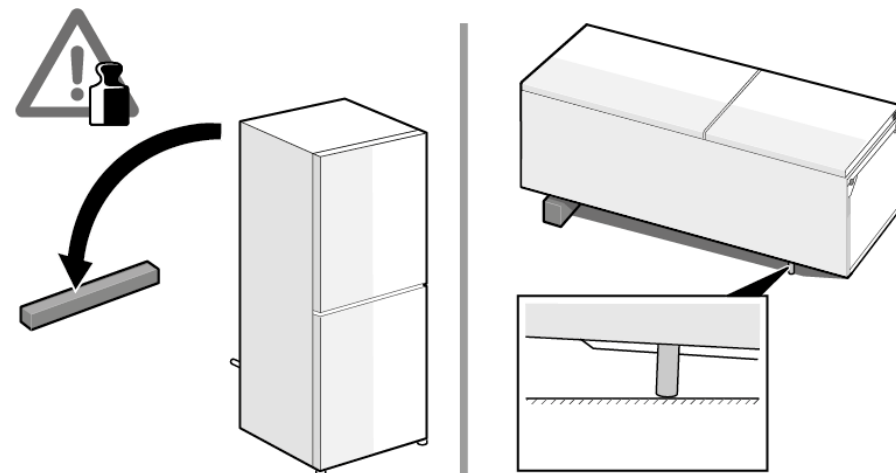

Repararea

2. 1. Apăsați capacul balamalei de sus pe ambele părți laterale (1).
2. Îndepărtați capacul balamalei de sus (2).
3. Rotiți capacul balamalei (3).
4. Demontați capacul balamalei de sus (4).
5. Deșurubați două șuruburi (5).
6. Demontați balamaua de sus (6)/

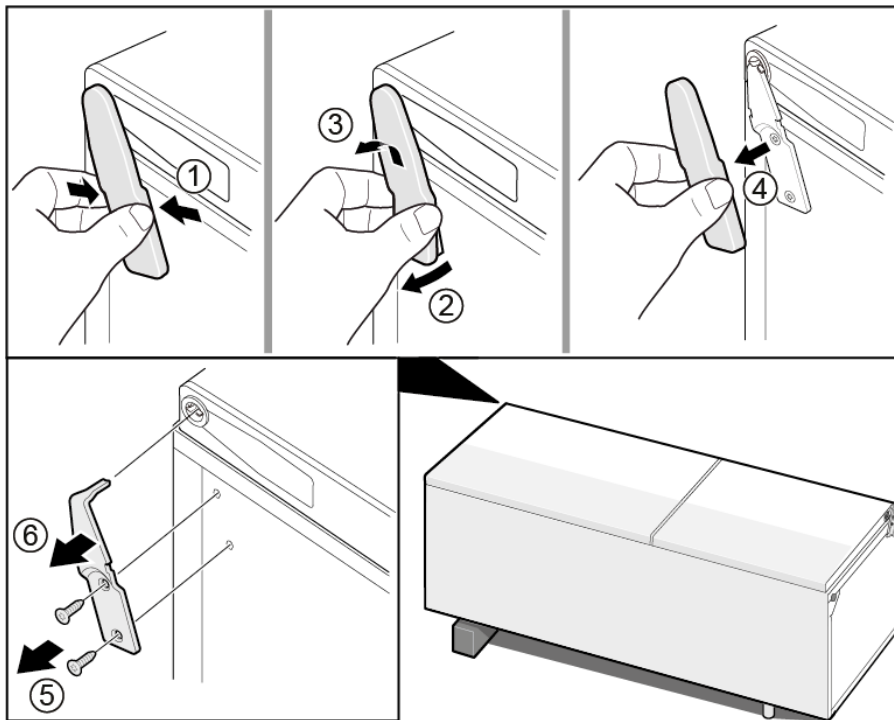

 Balamaua de sus este demontată.

4.3.2 Montarea balamalei de sus a ușii

- ▶ Montați urmând procedura de demontare în ordine inversă.

4.4 Înlocuirea balamalei de sus a ușii (ușă cu afișaj)

Scule speciale:

🌀 Cap torx TX20 6,3 mm (1/4") [00340865]

	⚠️ AVERTISMENT
	<p>Aparate grele, masive! Accidentarea spatelui și leziuni musculare</p> <ul style="list-style-type: none"> ▶ Operația de demontare a ușii aparatului trebuie efectuată numai de specialiști instruiți. ▶ Pentru deplasarea aparatului sunt necesare două persoane. ▶ Utilizați numai instrumente și echipamente adecvate.

	⚠️ ATENȚIONARE
	<p>Marginea ascuțită! Rănire prin tăiere</p> <ul style="list-style-type: none"> ▶ Purtați mănuși de protecție.

	⚠️ AVERTISMENT
	<p>Alunecarea aparatelor înclinate! Fracturi/zdrobiri</p> <ul style="list-style-type: none"> ▶ Fixați aparatele împotriva alunecării.

	⚠️ ATENȚIONARE
	<p>Pericol din cauza pieselor care cad pentru că șuruburile sunt slăbite! Accidente din cauza pieselor care cad.</p> <ul style="list-style-type: none"> ▶ Fixați componenta împotriva căderii.

	ATENȚIE!
	<p>Pericol din cauza pieselor care cad pentru că șuruburile sunt slăbite! Deteriorarea altor piese ale aparatului sau a casei clientului, de exemplu, partea de jos.</p> <ul style="list-style-type: none"> ▶ Fixați componenta împotriva căderii.

	⚠️ PERICOL
	<p>Pericol de electrocutare din cauza pieselor sub tensiune! Pericol de moarte prin electrocutare în cazul unei reparații necorespunzătoare</p> <ul style="list-style-type: none"> ▶ Componentele electrice trebuie reparate de către electricieni calificați. ▶ După reparație, este obligatorie efectuarea unei verificări de siguranță conform cu VDE 0701 sau cu reglementările naționale respective.

	⚠️ PERICOL
	<p>Pericol de electrocutare din cauza pieselor sub tensiune! Deces prin electrocutare</p> <ul style="list-style-type: none"> ▶ Deconectați aparatele de la sursa de alimentare cu tensiune cu cel puțin 60 de secunde înainte de a începe reparațiile.

Cerință:

- ✅ Aparatul este deconectat de la sursa de energie electrică.
- ✅ Fitingurile interioare ale aparatului sunt demontate.

4.4.1 Demontarea balamalei de sus a ușii

1. Așezați aparatul pe spate.

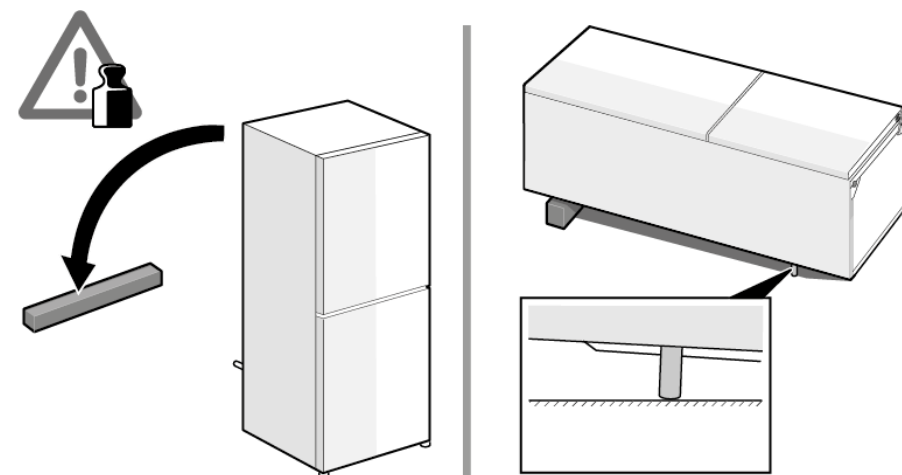

Repararea

2. 1. Demontați capacul balamalei de sus (1).
2. Demontați capacul cutiei de cabluri (2).
3. Deconectați conexiunea electrică (3).
4. Deșurubați șurubul conexiunii de împământare (4).
5. Demontați protecția cablurilor (5).
6. Deșurubați șurubul (6)

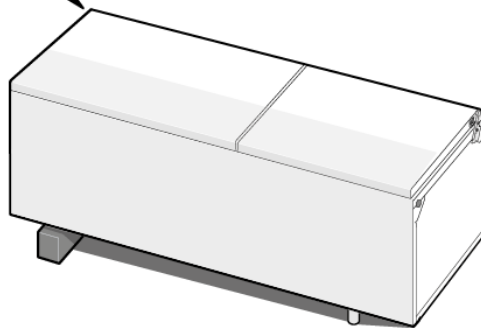
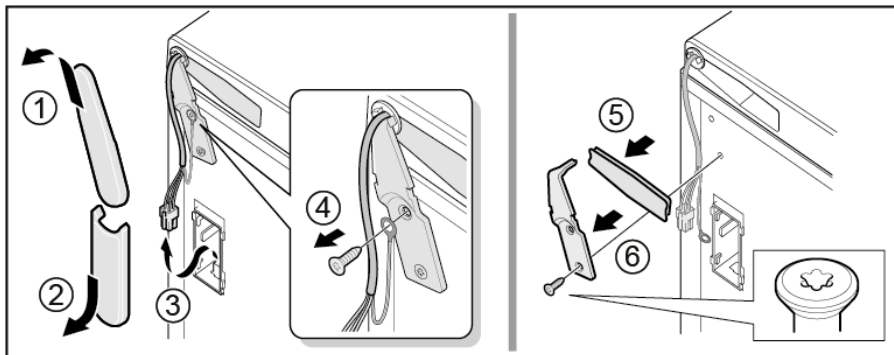

 Balama de sus este demontată.

4.4.2 Montarea balamalei de sus a ușii

- ▶ Montați urmând procedura de demontare în ordine inversă.

4.5 Înlocuirea balamalei din mijloc a ușii

Scule speciale:

Cap torx TX20 6,3 mm (1/4") [00340865]

	⚠️ AVERTISMENT
	<p>Aparate grele, masive! Accidentarea spatelui și leziuni musculare</p> <ul style="list-style-type: none"> ▶ Operația de demontare a ușii aparatului trebuie efectuată numai de specialiști instruiți. ▶ Pentru deplasarea aparatului sunt necesare două persoane. ▶ Utilizați numai instrumente și echipamente adecvate.

	⚠️ ATENȚIONARE
	<p>Marginea ascuțită! Rănire prin tăiere</p> <ul style="list-style-type: none"> ▶ Purtați mănuși de protecție.

	⚠️ AVERTISMENT
	<p>Alunecarea aparatelor înclinate! Fracturi/zdrobiri</p> <ul style="list-style-type: none"> ▶ Fixați aparatele împotriva alunecării.

	⚠️ ATENȚIONARE
	<p>Pericol din cauza pieselor care cad pentru că șuruburile sunt slăbite! Accidente din cauza pieselor care cad.</p> <ul style="list-style-type: none"> ▶ Fixați componenta împotriva căderii.

	ATENȚIE!
	<p>Pericol din cauza pieselor care cad pentru că șuruburile sunt slăbite! Deteriorarea altor piese ale aparatului sau a casei clientului, de exemplu, partea de jos.</p> <ul style="list-style-type: none"> ▶ Fixați componenta împotriva căderii.

Cerință:

- ✓ Aparatul este deconectat de la sursa de energie electrică.
- ✓ Fitingurile interioare ale aparatului sunt demontate.

- ✓ Balamaua de sus și este demontată.

4.5.1 Demontarea balamalei din mijloc a ușii

- ▶ 1. Scoateți ușa compartimentului frigiderului (1).
- ▶ 2. Deșurubați două șuruburi (2).
- ▶ 3. Scoateți balamaua din mijloc (3).

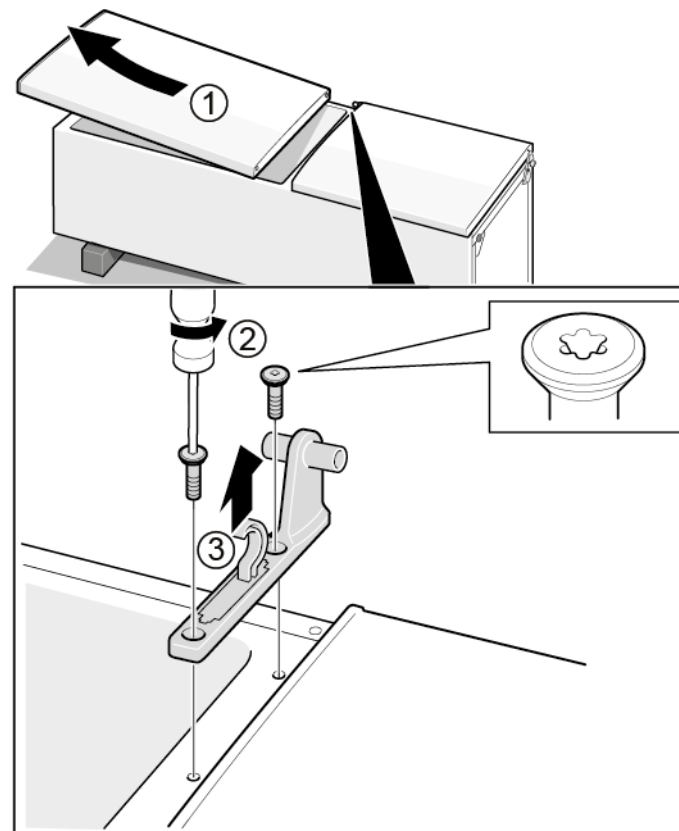

- ➡ Balamaua din mijloc este demontată.

4.5.2 Montarea balamalei din mijloc a ușii

- ▶ Montați urmând procedura de demontare în ordine inversă.



4.6 Înlocuirea balamalei de jos a ușii

Scule speciale:

🔩 Cap torx TX20

6,3 mm (1/4")

[00340865]

	<p>⚠️ AVERTISMENT</p> <p>Aparate grele, masive! Accidentarea spatelui și leziuni musculare</p> <ul style="list-style-type: none"> ▶ Operația de demontare a ușii aparatului trebuie efectuată numai de specialiști instruiți. ▶ Pentru deplasarea aparatului sunt necesare două persoane. ▶ Utilizați numai instrumente și echipamente adecvate.
	<p>⚠️ ATENȚIONARE</p> <p>Marginea ascuțită! Rănire prin tăiere</p> <ul style="list-style-type: none"> ▶ Purtați mănuși de protecție.
	<p>⚠️ AVERTISMENT</p> <p>Alunecarea aparatelor înclinate! Fracturi/zdrobiri</p> <ul style="list-style-type: none"> ▶ Fixați aparatele împotriva alunecării.
	<p>⚠️ ATENȚIONARE</p> <p>Pericol din cauza pieselor care cad pentru că șuruburile sunt slăbite! Accidente din cauza pieselor care cad.</p> <ul style="list-style-type: none"> ▶ Fixați componenta împotriva căderii.
	<p>⚠️ ATENȚIE!</p> <p>Pericol din cauza pieselor care cad pentru că șuruburile sunt slăbite! Deteriorarea altor piese ale aparatului sau a casei clientului, de exemplu, partea de jos.</p> <ul style="list-style-type: none"> ▶ Fixați componenta împotriva căderii.

Cerință:

- ✔️ Aparatul este deconectat de la sursa de energie electrică.
- ✔️ Fitingurile interioare ale aparatului sunt demontate.

- ✔️ Balamaua de sus este demontată.
- ✔️ Balamaua din mijloc este demontată.

4.6.1 Demontarea balamalei de jos a ușii

- ▶ 1. Scoateți ușa compartimentului congelatorului (1).
- ▶ 2. Deșurubați șurubul (2).
- ▶ 3. Rotiți și scoateți balamaua de sus (3).
- ▶ 4. Demontați balamaua de jos (4).

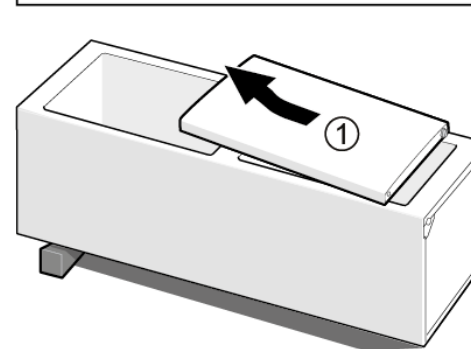
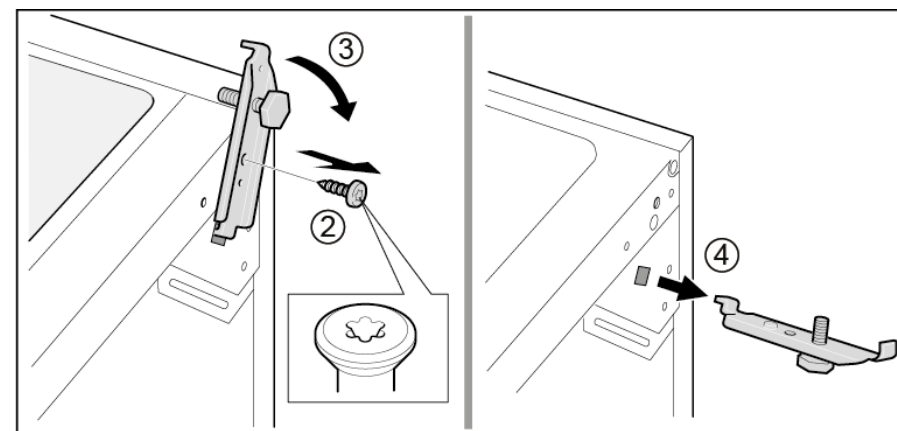

- ➡️ Balamaua de jos a ușii este demontată.

4.6.2 Montarea balamalei de jos a ușii

- ▶ Montați urmând procedura de demontare în ordine inversă.

4.7 Repoziționarea raftului

Cerință:

- ✔ Ușa este deschisă.

4.7.1 Demontarea raftului

- ▶ Scoateți raftul.

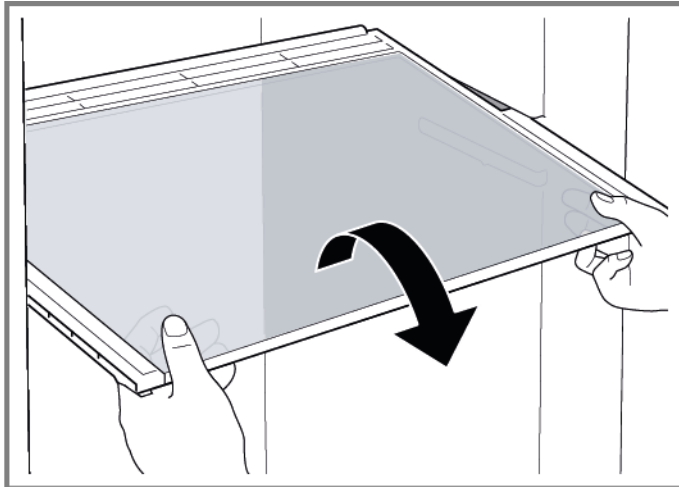

- ➡ Raftul este demontat.

4.7.2 Montarea raftului

- ▶ Montați urmând procedura de demontare în ordine inversă.

4.8 Repoziționarea suportului pentru sticle

Cerință:

- ✓ Ușa este deschisă.

4.8.1 Demontarea suportului pentru sticle

- ▶ Trageți suportul pentru sticle pentru a-l scoate.

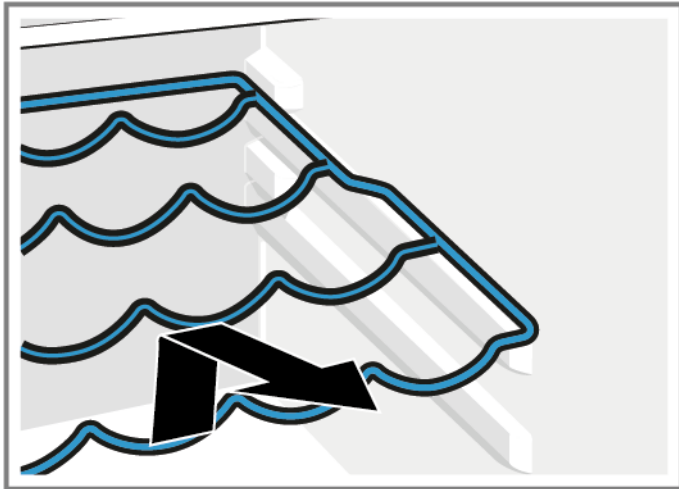

- ➡ Suportul pentru sticle este demontat.

4.8.2 Montarea suportului pentru sticle

- ▶ Montați urmând procedura de demontare în ordine inversă.

4.9 Repoziționarea raftului pentru ușă

Cerință:

- ✔ Ușa este deschisă.

4.9.1 Demontarea raftului pentru ușă

- ▶ Ridicați raftul pentru ușă.

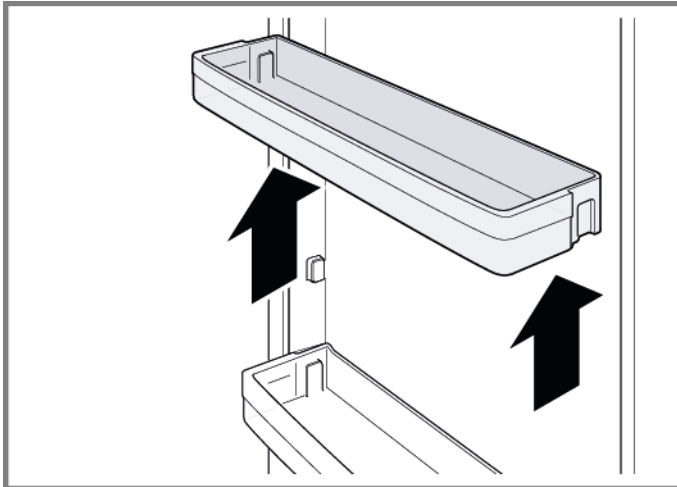

- ➡ Raftul pentru ușă este demontat.

4.9.2 Montarea raftului pentru ușă

- ▶ Montați urmând procedura de demontare în ordine inversă.

4.10 Repoziționarea raftului pentru ușă reglabil

Cerință:

- ✔ Ușa este deschisă.

4.10.1 Demontarea raftului pentru ușă reglabil

- ▶ Deplasați în sus raftul pentru ușă reglabil pe înălțime, până când raftul pentru ușă este eliberat în suport.

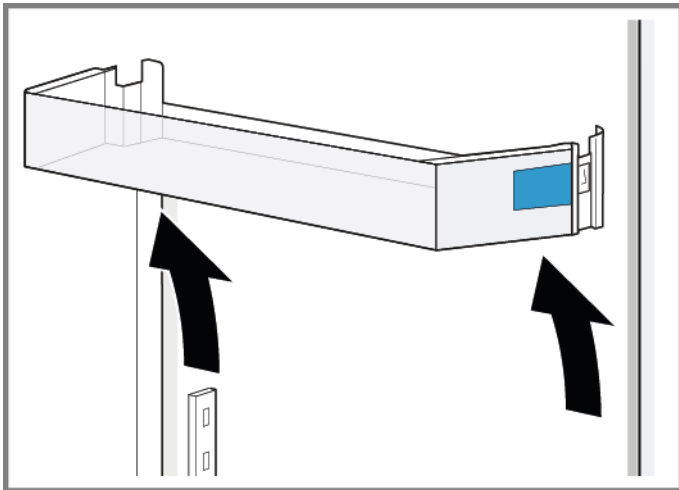

- ➡ Raftul de ușă reglabil este demontat.

4.10.2 Montarea raftului pentru ușă reglabil

- ▶ Montați urmând procedura de demontare în ordine inversă.

4.11 Repoziționarea containerului pentru alimente înghețate

Cerință:

- ✔ Ușa este deschisă.

4.11.1 Demontarea containerului pentru alimente înghețate

- ▶ 1. Extrageți complet containerul pentru alimente înghețate (1).
- ▶ 2. Demontați containerul pentru alimente (2).

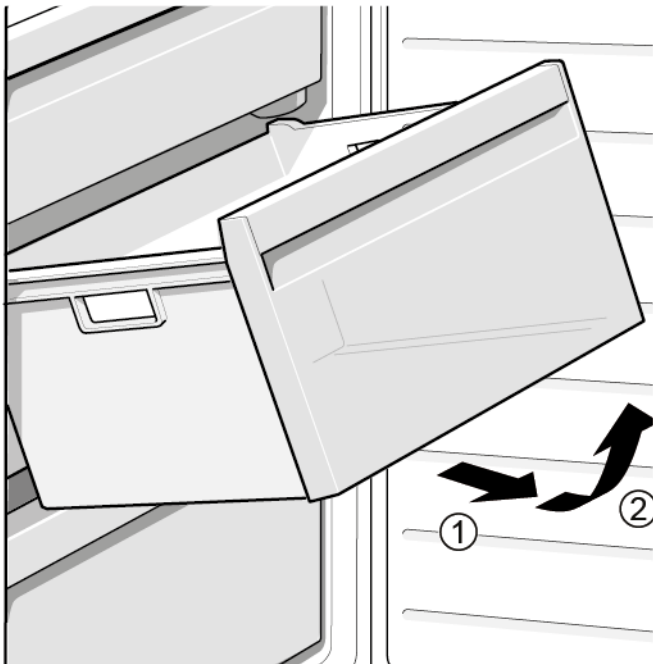

- ➡ Containerul pentru alimente înghețate este demontat.

4.11.2 Montarea containerului pentru alimente înghețate

- ▶ Montați urmând procedura de demontare în ordine inversă.

4.12 Repoziționarea containerului

Cerință:

- ✔ Ușa este deschisă.

4.12.1 Demontarea containerului

- ▶ 1. Demontați containerul de jos al frigiderului (1).
- ▶ 2. Demontați containerul de sus al frigiderului (2).

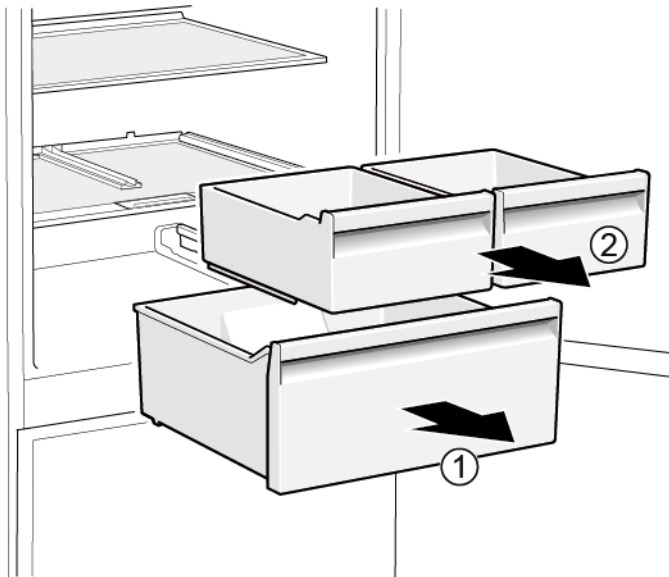

- ➡ Containerele sunt demontate.

4.12.2 Montarea containerului

- ▶ Montați urmând procedura de demontare în ordine inversă.

4.13 Repoziționarea containerului extensibil

Cerință:

- ✔ Ușa este deschisă.

4.13.1 Demontarea containerului extensibil

- ▶ 1. Extrageți complet containerul extensibil (1).
- ▶ 2. Demontați containerul extensibil (2).

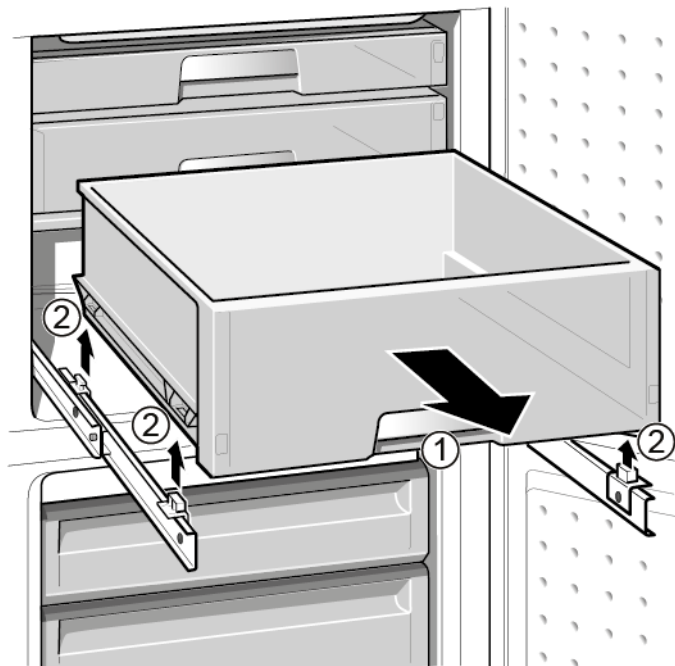

- ➡ Containerul extensibil este demontat.

4.13.2 Montarea containerului extensibil

- ▶ Montați urmând procedura de demontare în ordine inversă.

4.14 Înlocuirea spotului luminos LED

Scule speciale:

 Instrument special [00342180]



Aparatul dumneavoastră este echipat cu o lampă LED care nu necesită întreținere.
Acele lămpi pot fi înlocuite numai de către departamentul de service pentru clienți sau de către tehnicieni autorizați!



PERICOL

Pericol de electrocutare din cauza pieselor sub tensiune!

Pericol de moarte prin electrocutare în cazul unei reparații necorespunzătoare

- ▶ Componentele electrice trebuie reparate de către electricieni calificați.
- ▶ După reparație, este obligatorie efectuarea unei verificări de siguranță conform cu VDE 0701 sau cu reglementările naționale respective.



PERICOL

Pericol de electrocutare din cauza pieselor sub tensiune!

Deces prin electrocutare

- ▶ Deconectați aparatele de la sursa de alimentare cu tensiune cu cel puțin 60 de secunde înainte de a începe reparațiile.





ATENȚIONARE

Marginea ascuțite!

Rănire prin tăiere

- ▶ Purtați mănuși de protecție.

Cerință:

-  Aparatul este deconectat de la sursa de energie electrică.
-  Ușa este deschisă.

4.14.1 Demontarea spotului luminos LED

1. Utilizați instrumentul special pentru a trage spotul luminos LED afară (1).

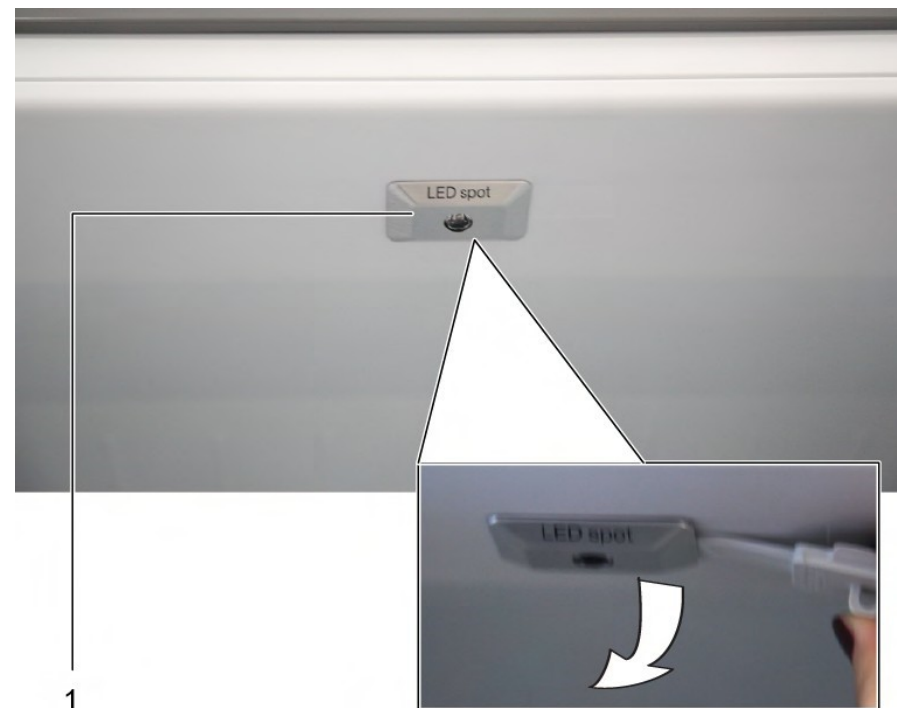

2. Deconectați conexiunile electrice ale spotului luminos LED.
 Sportul luminos LED este demontat.

4.14.2 Montarea spotului luminos LED

- ▶ Montați urmând procedura de demontare în ordine inversă.

4.15 Înlocuirea lămpii LED de sus

Scule speciale:

🔧 Șurubelniță plată

Lamă de 2,4 mm x 0,4 mm x 60 mm,
în kitul [00341820]



Aparatul dumneavoastră este echipat cu o lampă LED care nu necesită întreținere.
Aceste lămpi pot fi înlocuite numai de către departamentul de service pentru clienți sau de către tehnicieni autorizați!



⚠️ PERICOL

Pericol de electrocutare din cauza pieselor sub tensiune!

Pericol de moarte prin electrocutare în cazul unei reparații necorespunzătoare

- ▶ Componentele electrice trebuie reparate de către electricieni calificați.
- ▶ După reparație, este obligatorie efectuarea unei verificări de siguranță conform cu VDE 0701 sau cu reglementările naționale respective.



⚠️ PERICOL

Pericol de electrocutare din cauza pieselor sub tensiune!

Deces prin electrocutare

- ▶ Deconectați aparatele de la sursa de alimentare cu tensiune cu cel puțin 60 de secunde înainte de a începe reparațiile.



⚠️ ATENȚIONARE

Marginea ascuțită!

Rănire prin tăiere

- ▶ Purtați mănuși de protecție.

Cerință:

- ✔️ Aparatul este deconectat de la sursa de energie electrică.
- ✔️ Ușa este deschisă.
- ✔️ Fitingurile interioare din partea de sus sunt demontate.

4.15.1 Demontarea lămpii LED

1. Deplasați lampa LED spre stânga.

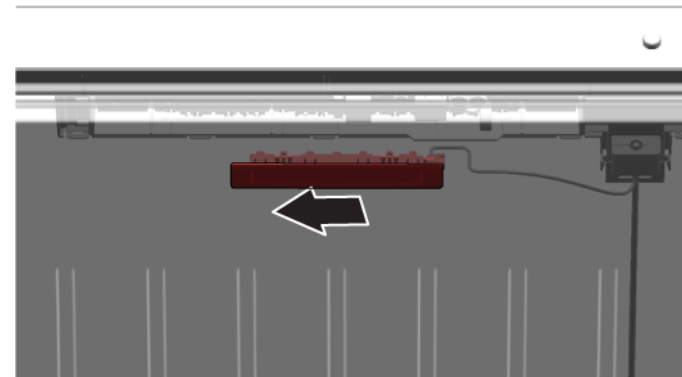

- ➡️ Conexiunea electrică a lămpii LED este deconectată.

2. Decuplați cârligele lămpii LED.

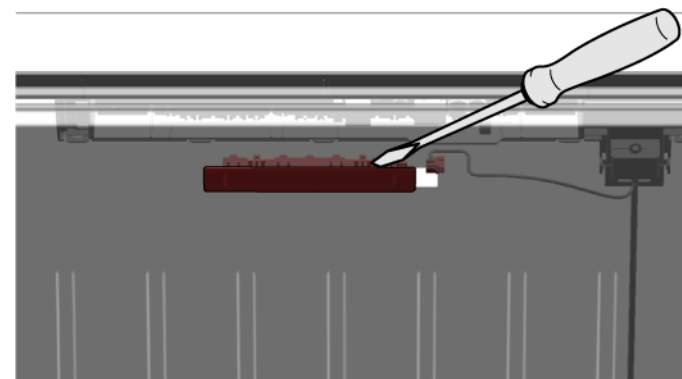

Repararea

3. Demontați lampa LED deplasând-o în față.

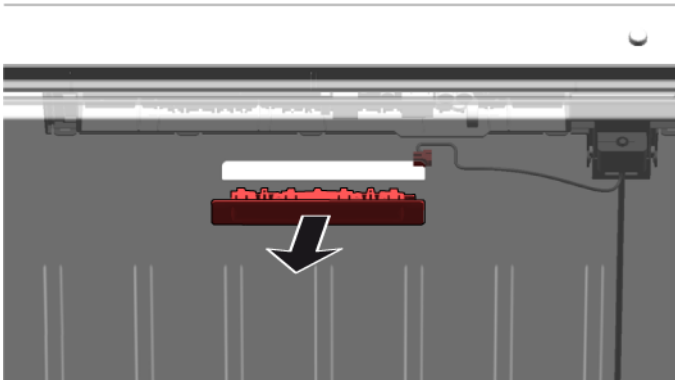

- ➔ Lampa LED este demontată.

4.15.2 Montarea lămpii LED de sus

- ▶ Montați urmând procedura de demontare în ordine inversă.

4.16 Înlocuirea lămpii LED de pe bara laterală

Scule speciale:

 Ventuză Ø50 mm [00342224]



Aparatul dumneavoastră este echipat cu o lampă LED care nu necesită întreținere.
Aceste lămpi pot fi înlocuite numai de către departamentul de service pentru clienți sau de către tehnicieni autorizați!



PERICOL

Pericol de electrocutare din cauza pieselor sub tensiune!

Pericol de moarte prin electrocutare în cazul unei reparații necorespunzătoare

- ▶ Componentele electrice trebuie reparate de către electricieni calificați.
- ▶ După reparație, este obligatorie efectuarea unei verificări de siguranță conform cu VDE 0701 sau cu reglementările naționale respective.



PERICOL

Pericol de electrocutare din cauza pieselor sub tensiune!

Deces prin electrocutare

- ▶ Deconectați aparatele de la sursa de alimentare cu tensiune cu cel puțin 60 de secunde înainte de a începe reparațiile.



ATENȚIONARE

Marginea ascuțite!

Rănire prin tăiere

- ▶ Purtați mănuși de protecție.

Cerință:

- ✓ Aparatul este deconectat de la sursa de energie electrică.
- ✓ Ușa este deschisă.
- ✓ Rafturile din compartimentul frigiderului sunt demontate.

4.16.1 Demontarea lămpii LED de pe bara laterală

1. Aplicați ventuză în treimea superioară a lămpii LED de pe bara laterală.



Repararea

- Trageți în față ventuza cu lampa LED de pe bara laterală, cu o mișcare de rotație.

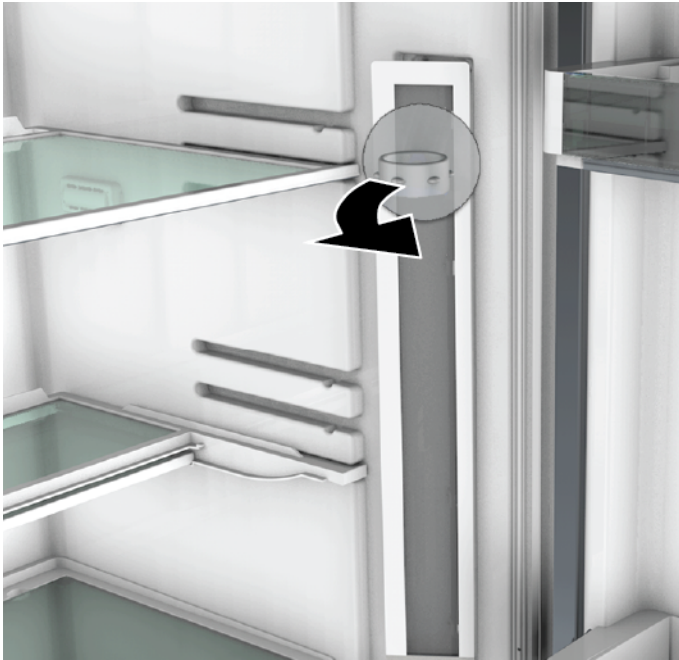

- Deconectați conexiunea electrică a lămpii LED de pe bara laterală.
➡ Lampa LED de pe bara laterală este demontată.

4.16.2 Montarea lămpii LED de pe bara laterală

- Conectați conexiunea electrică a lămpii LED de pe bara laterală.
 - Fixați lampa LED de pe bara laterală în locația sa de pe peretele compartimentului (cârligele se fixează cu un clic).
- ➡ Lampa LED de pe bara laterală este montată.

4.17 Înlocuirea spotului luminos LED

Scule speciale:

- 🔧 Instrument special [00342180]
- 🔧 Șurubelniță plată Lamă de 2,4 mm x 0,4 mm x 60 mm, în kitul [00341820]



Aparatul dumneavoastră este echipat cu o lampă LED care nu necesită întreținere. Aceste lămpi pot fi înlocuite numai de către departamentul de service pentru clienți sau de către tehnicieni autorizați!



⚠️ PERICOL

Pericol de electrocutare din cauza pieselor sub tensiune!

Pericol de moarte prin electrocutare în cazul unei reparații necorespunzătoare

- ▶ Componentele electrice trebuie reparate de către electricieni calificați.
- ▶ După reparație, este obligatorie efectuarea unei verificări de siguranță conform cu VDE 0701 sau cu reglementările naționale respective.



⚠️ PERICOL

Pericol de electrocutare din cauza pieselor sub tensiune!

Deces prin electrocutare

- ▶ Deconectați aparatele de la sursa de alimentare cu tensiune cu cel puțin 60 de secunde înainte de a începe reparațiile.



⚠️ ATENȚIONARE

Marginea ascuțite!

Rănire prin tăiere

- ▶ Purtați mănuși de protecție.

Cerință:

- ✔️ Aparatul este deconectat de la sursa de energie electrică.
- ✔️ Ușa este deschisă.
- ✔️ Rafturile din compartimentul frigiderului sunt demontate.

4.17.1 Demontarea spotului luminos LED

1. Eliberați capacul spotului luminos LED.

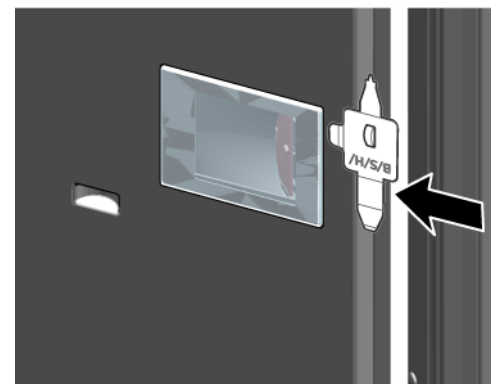

2. Trageți capacul spotului luminos LED în interior și simultan împingeți-l în față.

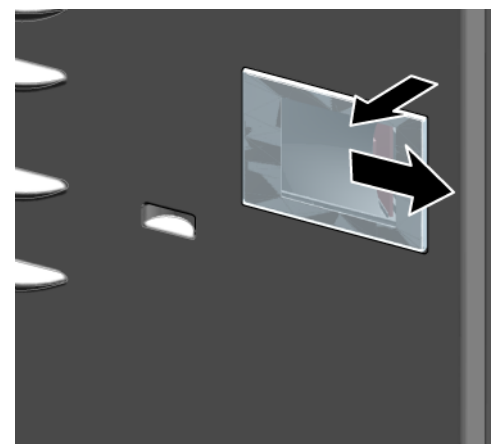

Repararea

3. Detașați modulul spotului luminos LED.

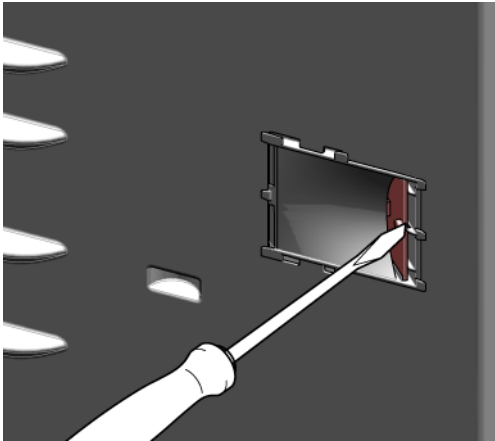

4. Deconectați conexiunea electrică a spotului luminos LED.

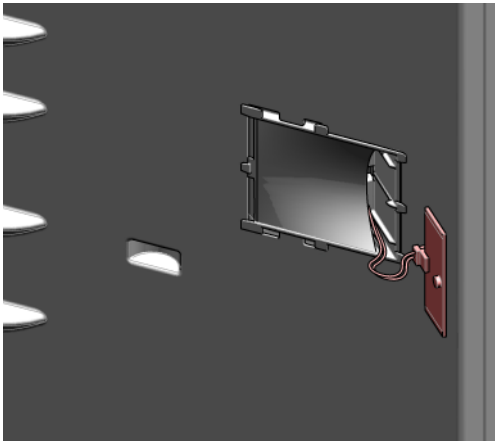





-  Sportul luminos LED este demontat.

4.17.2 Montarea spotului luminos LED

- ▶ Montați urmând procedura de demontare în ordine inversă.

Poznámky k opravám - Kombinácia chladničky a mrazničky

 O tomto dokumente	554	4.8	Výmena odkladacieho priestoru na fľaše	569
1.1 Dôležité informácie	554	4.8.1	Odobratie odkladacieho priestoru na fľaše	569
1.1.1 Účel	554	4.8.2	Montáž odkladacieho priestoru na fľaše	569
1.2 Vysvetlenie symbolov	554	4.9	Výmena poličky v dvierkach.....	570
1.2.1 Úrovne nebezpečenstva	554	4.9.1	Odobratie poličky v dvierkach.....	570
1.2.2 Symboly označujúce riziká.....	554	4.9.2	Montáž poličky do dvierok	570
1.2.3 Štruktúra varovaní.....	555	4.10	Výmena nastaviteľnej poličky v dvierkach	571
1.2.4 Všeobecné symboly	555	4.10.1	Odobratie nastaviteľnej poličky v dvierkach	571
 Bezpečnosť	556	4.10.2	Montáž nastaviteľnej poličky do dvierok	571
2.1 Všeobecné bezpečnostné pokyny	556	4.11	Výmena nádoby na zmrazené potraviny	572
2.1.1 Všetky domáce spotrebiče.....	556	4.11.1	Odobratie nádoby na zmrazené potraviny	572
 Nástroje a pomôcky	557	4.11.2	Montáž nádoby na zmrazené potraviny.....	572
 Oprava	558	4.12	Výmena nádoby.....	573
4.1 Výmena tesnenia dvierok	558	4.12.1	Odobratie nádoby.....	573
4.1.1 Odoberanie tesnenia dvierok	558	4.12.2	Montáž nádoby.....	573
4.1.2 Montáž tesnenia dvierok.....	558	4.13	Výmena výsuvnej nádoby.....	574
4.2 Výmena dverovej úchytky	561	4.13.1	Odobratie výsuvnej nádoby	574
4.2.1 Odoberanie dverovej úchytky.....	561	4.13.2	Montáž výsuvnej nádoby.....	574
4.2.2 Montáž dverovej úchytky	561	4.14	Výmena bodového LED svetla	575
4.3 Výmena horného závesu dverí	562	4.14.1	Odoberanie bodového LED svetla	575
4.3.1 Odoberanie horného závesu dvierok	562	4.14.2	Montáž bodového LED svetla	575
4.3.2 Montáž horného závesu dvierok.....	563	4.15	Výmena horného LED svetla	576
4.4 Výmena horného závesu dvierok (dvierka s displejom).....	564	4.15.1	Odobratie LED osvetlenia	576
4.4.1 Odoberanie horného závesu dvierok	564	4.15.2	Montáž horného LED svetla	577
4.4.2 Montáž horného závesu dvierok.....	565	4.16	Výmena bočného pásového LED svetla	578
4.5 Výmena prostredného závesu dverí.....	566	4.16.1	Odobratie bočného pásového LED svetla	578
4.5.1 Odoberanie prostredného závesu dverí	566	4.16.2	Montáž bočného pásového LED svetla	579
4.5.2 Montáž prostredného závesu dverí	566	4.17	Výmena bodového LED svetla	580
4.6 Výmena spodného závesu dvierok	567	4.17.1	Odoberanie bodového LED svetla	580
4.6.1 Odoberanie spodného závesu dverí	567	4.17.2	Montáž bodového LED svetla.....	581
4.6.2 Montáž spodného závesu dvierok	567			
4.7 Výmena odkladacej plochy.....	568			
4.7.1 Odobratie odkladacej plochy.....	568			
4.7.2 Montáž odkladacej plochy	568			

i O tomto dokumente

1.1 Dôležité informácie

1.1.1 Účel

Tieto pokyny pre opravu pomáhajú spotrebiteľovi pri vlastnej oprave spotrebičov podľa nariadenia o ekodizajne (z marca 2021).

Obsahujú informácie o výmene určených náhradných dielov vrátane varovaní a rizík.

Ak máte otázky, kontaktujte náš zákaznícky servis. Za poškodenia ručíme len vtedy, ak pokyny boli dodržané správne.

1.2 Vysvetlenie symbolov

1.2.1 Úrovne nebezpečenstva

Úroveň varovania obsahuje symbol a signalizačné slovo. Signalizačné slovo naznačuje mieru nebezpečenstva.





Úroveň varovania	Význam
 NEBEZPEČENSTVO	Následkom nerešpektovania varovného hlásenia je úmrtie alebo vážne zranenia.
 VAROVANIE	Možným následkom nerešpektovania varovného hlásenia je úmrtie alebo vážne zranenia.
 UPOZORNENIE	Možným následkom nerešpektovania varovného hlásenia sú mierne zranenia.
 POZOR!	Možným následkom nerešpektovania varovného hlásenia je poškodenie majetku.

Tabuľka 1: Úrovne nebezpečenstva



1.2.2 Symboly označujúce riziká

Symboly označujúce riziká sú symbolické znázornenia, ktoré naznačujú druh nebezpečenstva.

V tomto dokumente sa používajú nasledujúce symboly označujúce riziká:

Symbol označujúci riziko	Význam
	Všeobecné varovné hlásenie
	Nebezpečenstvo v súvislosti s elektrickým napätím
	Nebezpečenstvo výbuchu
	Nebezpečenstvo porezania
	Nebezpečenstvo pomliaždenia

i O tomto dokumente

Symbol označujúci riziko	Význam
	Nebezpečenstvo v súvislosti s horúcimi povrchmi
	Nebezpečenstvo v súvislosti s magnetickým poľom
	Nebezpečenstvo v súvislosti s neionizujúcou radiáciou

Tabuľka 2: Symboly označujúce riziká

1.2.3 Štruktúra varovaní

Varovania v tomto dokumente majú štandardný vzhľad a štandardnú štruktúru.



	<p>⚠ NEBEZPEČENSTVO</p> <p>Druh a zdroj nebezpečenstva! Možné následky pri ignorovaní nebezpečenstva/varovania.</p> <ul style="list-style-type: none"> ▶ Opatrenia a zákazy na zabránenie nebezpečenstvu.
--	--





Nasledujúci príklad znázorňuje varovanie pred zásahom elektrickým prúdom pri dotyku s časťami pod napätím. Je uvedené opatrenie na predídenie nebezpečenstvu.

	<p>⚠ NEBEZPEČENSTVO</p> <p>Nebezpečenstvo úrazu elektrickým prúdom pri dotyku s časťami pod napätím! Úmrtie v dôsledku zásahu elektrickým prúdom</p> <ul style="list-style-type: none"> ▶ Odpojte spotrebiče od elektrického zdroja aspoň 60 sekúnd pred začiatkom opráv.
---	--

1.2.4 Všeobecné symboly

V tomto dokumente sa používajú nasledujúce všeobecné symboly:

Všeob. symbol	Význam
	Označenie špeciálneho pokynu (textové a/alebo grafické)
	Označenie jednoduchého pokynu (len textové)

Všeob. symbol	Význam
	Označenie prepojenia na videonávod
	Označenie požadovaných nástrojov
	Označenie požadovaných podmienok
	Označenie podmienky (ak ..., potom ...)
	Označenie výsledku
[Spustenie]	Označenie klávesu alebo tlačidla
[00123456]	Označenie čísla materiálu
Stav	Označenie zobrazeného textu/okna (na displeji spotrebiča)

Tabuľka 3: Všeobecné symboly

2.1 Všeobecné bezpečnostné pokyny

2.1.1 Všetky domáce spotrebiče

Nebezpečenstvo úrazu elektrickým prúdom pri dotyku s časťami pod napätím!

- Chyby pri opravách na elektrických komponentoch môžu spôsobiť zásah elektrickým prúdom!
- Odpojte spotrebič od elektrickej siete aspoň 60 sekúnd pred začiatkom práce.
- Po oprave zariadenia vykonajte bezpečnostný test v súlade s nariadením VDE 0701 alebo s miestnymi nariadeniami.

Riziko poranenia na ostrých hranách!

- Noste ochranné rukavice.

Riziko pomliaždenia počas opravy, údržby, riešenia problémov a servisu na ťažkých a pohybujúcich sa komponentoch

- Noste ochrannú obuv.
- Zaisťujte ťažké komponenty proti pádu.
- Nesiahajte končatinami do pohybujúcich sa komponentov.





Riziko ohrozenia bezpečnosti/funkčnosti spotrebiča!

- Používajte len originálne náhradné diely.

Riziko poškodenia elektrostaticky citlivých komponentov (ESD)!

- Nedotýkajte sa modulov vrátane prípojok a vedení vodičov.

Nástroje a pomôcky

Označenie	Detaily	Snímky
Ochranná látka [00342013]	60 cm x 50 cm	
Plochý skrutkovač	Čepeľ 2,4 mm x 0,4 mm x 60 mm, v sade [00341820]	
Špeciálny nástroj [00342180]		
Prísavný držiak [00342224]	Ø50 mm	
Bit Torx TX20 [00340865]	6,3 mm (1/4")	
Plochý skrutkovač	Čepeľ 10 mm x 1,6 mm x 200 mm	

4.1 Výmena tesnenia dvierok

Požiadavka:

- ✔ Dvierka sú otvorené.

4.1.1 Odoberanie tesnenia dvierok

1. Uvoľnite tesnenie dvierok z drážky na pravom a ľavom rohu.



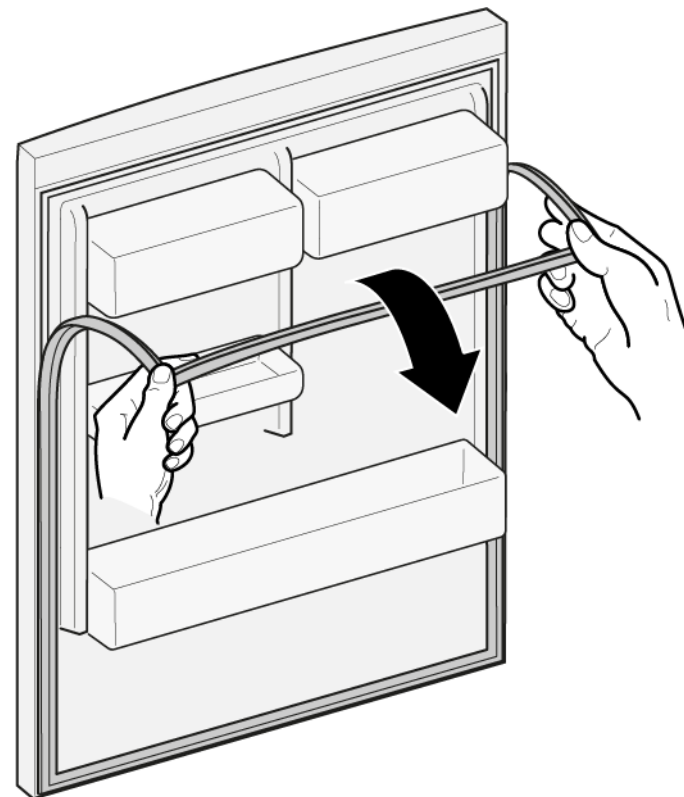

2. Vytiahnite tesnenie z drážky.



- ➡ Tesnenie dvierok je odobraté.

4.1.2 Montáž tesnenia dvierok

	Hrúbka nového tesnenia dvierok sa môže mierne odlišovať od hrúbky starého tesnenia dvierok. Neovplyvní to zatváranie ani funkčnosť z dlhodobého hľadiska.
	Ak má váš spotrebič nastaviteľné závesy alebo závesové úchytky, postupne môžete optimalizovať spôsob zatvárania.
	Malé bočné dierky v tesnení dvierok majú svoju funkciu (sú potrebné na vetranie). Nie sú výrobnou chybou.

1. Skontrolujte poškodenie drážky na tesnenie.

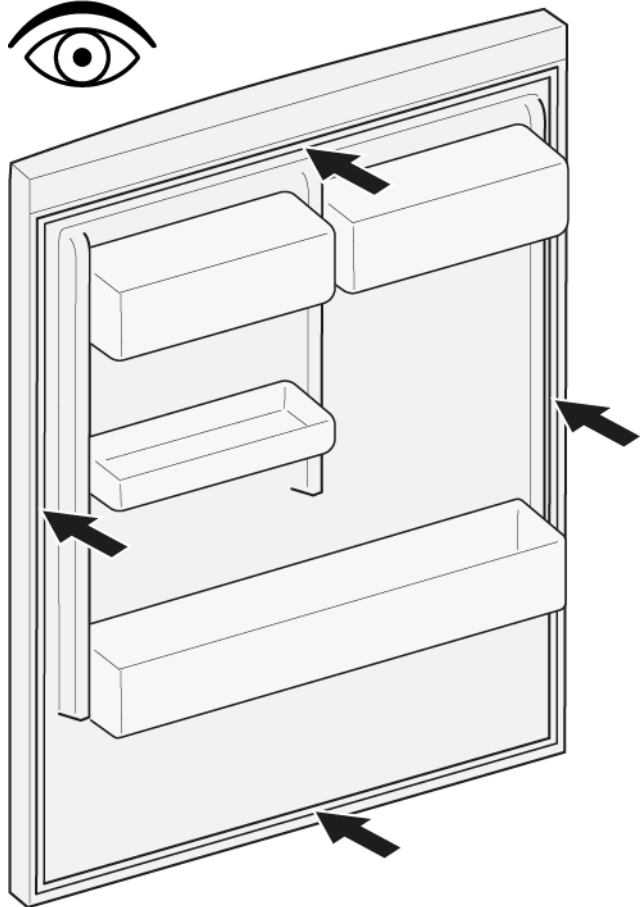

4. Hore a dole vtláčte rohy tesnenia do drážky.

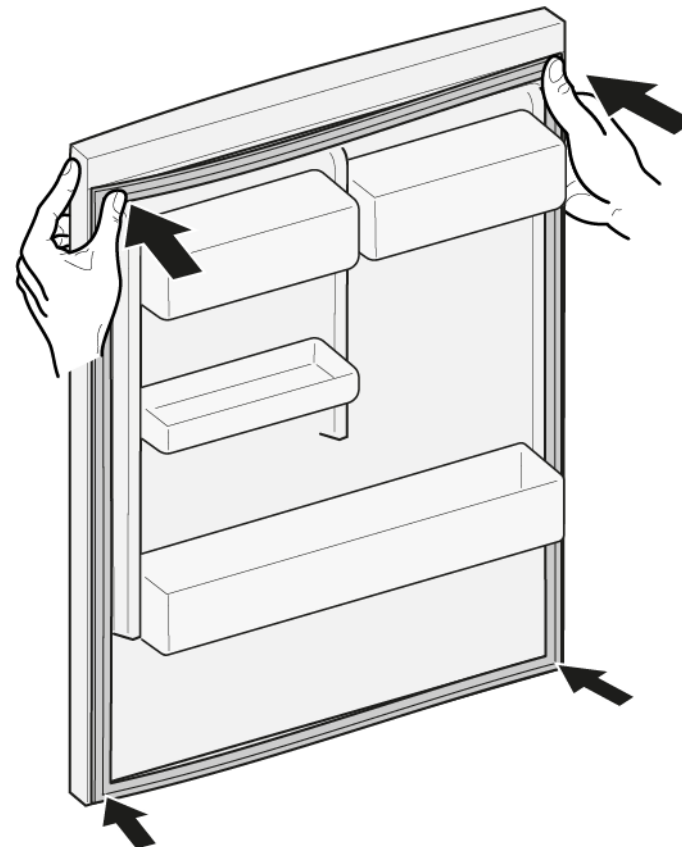

2.  Ak je drážka tesnenia je poškodená.
- Kontaktujte zákaznícky servis.

3.  Mierna deformácia tesnenia dvierok je normálna a neovplyvňuje jeho funkciu. Odporúča sa vyrovnať tesnenie pred jeho vloženíom do spotrebiča.

Nahrejte tesnenie dvierok použitím fénu alebo horúcej vody a manuálne ho vytvarujte.

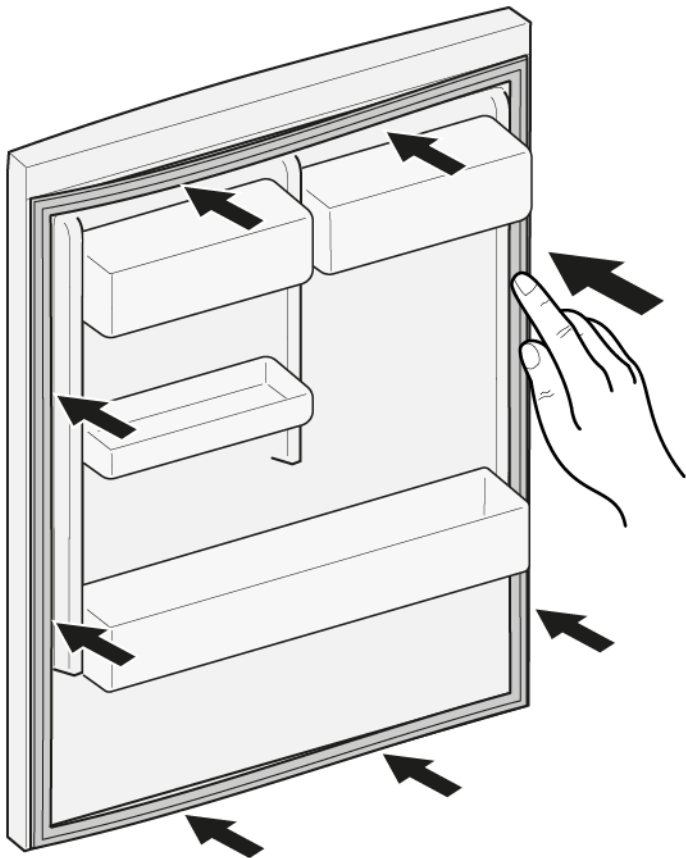

5. Jedno miesto po druhom vtlačte celé tesnenie do drážky.





-  Tesnenie dvierok je namontované.

4.2 Výmena dverovej úchytky

Špeciálne nástroje:

-  Bit Torx TX20 6,3 mm (1/4") [00340865]
-  Plochý skrutkovač Čepel' 10 mm x 1,6 mm x 200 mm

Požiadavka:

-  Spotrebič je odpojený od elektrického napájania.
-  Dvierka sú otvorené.

4.2.1 Odoberanie dverovej úchytky

- ▶ 1. Odoberte dve krytky skrutiek (1).
- ▶ 2. Odskrutkujte dve skrutky (2).
- ▶ 3. Odoberte dverovú úchytку (3).

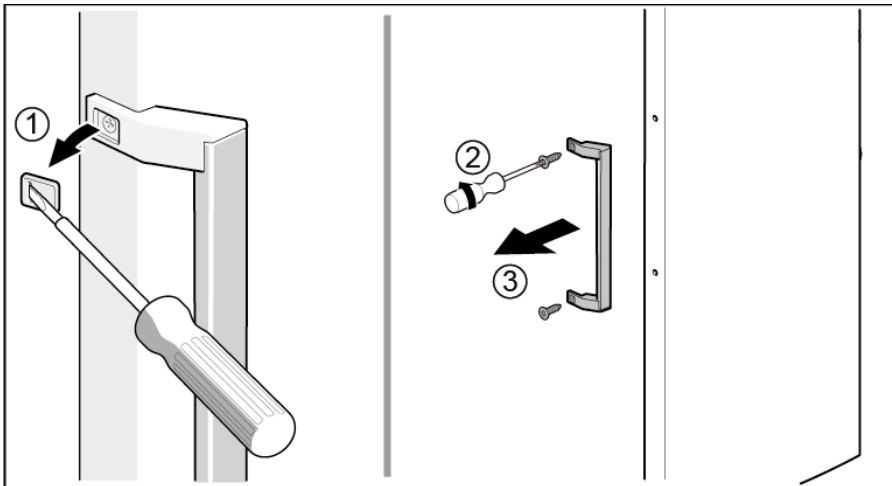

 Dverová úchytka je odobratá.



Dverová úchytka druhých dvierok sa dá odobrať rovnakým spôsobom.

4.2.2 Montáž dverovej úchytky

- ▶ Pri montáži postupujte v opačnom poradí krokov demontáže.

4.3 Výmena horného závesu dverí

Špeciálne nástroje:

 Bit Torx TX20 6,3 mm (1/4") [00340865]

	<p style="text-align: center;">VAROVANIE</p> <p>Ťažké, objemné spotrebiče! Poranenie chrbta a svalov</p> <ul style="list-style-type: none"> ▶ Proces odoberania dverí spotrebiča by mal vykonávať školený odborník. ▶ Na presunutie spotrebiča sa vyžadujú dve osoby. ▶ Použite vhodné nástroje a vybavenie.
--	---



	<p style="text-align: center;">UPOZORNENIE</p> <p>Ostré hrany! Rezné poranenia</p> <ul style="list-style-type: none"> ▶ Noste ochranné rukavice.
--	---

	<p style="text-align: center;">VAROVANIE</p> <p>Zošmyknutie naklonených spotrebičov! Zlomeniny/pomliaždenia</p> <ul style="list-style-type: none"> ▶ Zaistite spotrebiče proti zošmyknutiu.
--	--

	<p style="text-align: center;">UPOZORNENIE</p> <p>Riziko pádu dielov po uvoľnení skrutiek! Zranenie padajúcimi dielmi.</p> <ul style="list-style-type: none"> ▶ Zaistite komponent proti pádu.
---	---

	<p style="text-align: center;">POZOR!</p> <p>Riziko pádu dielov po uvoľnení skrutiek! Poškodenie iných častí spotrebiča alebo domácnosti zákazníka, napr. podlahy.</p> <ul style="list-style-type: none"> ▶ Zaistite komponent proti pádu.
--	---

Požiadavka:

-  Spotrebič je odpojený od elektrického napájania.
-  Tvarovky z interiéru spotrebiča sú odobraté.

4.3.1 Odoberanie horného závesu dverí

1. Spotrebič dajte na zadnú stranu.

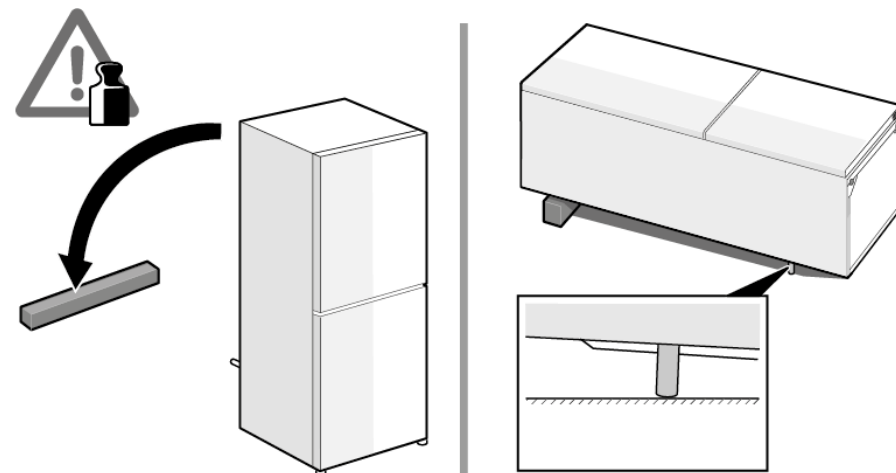

2. 1. Na oboch stranách stlačte kryt horného závesu (1).
2. Vytiahnite kryt horného závesu (2).
3. Otočte kryt závesu (3).
4. Odoberte kryt horného závesu (4).
5. Odskrutkujte dve skrutky (5).
6. Odoberte horný záves (6)

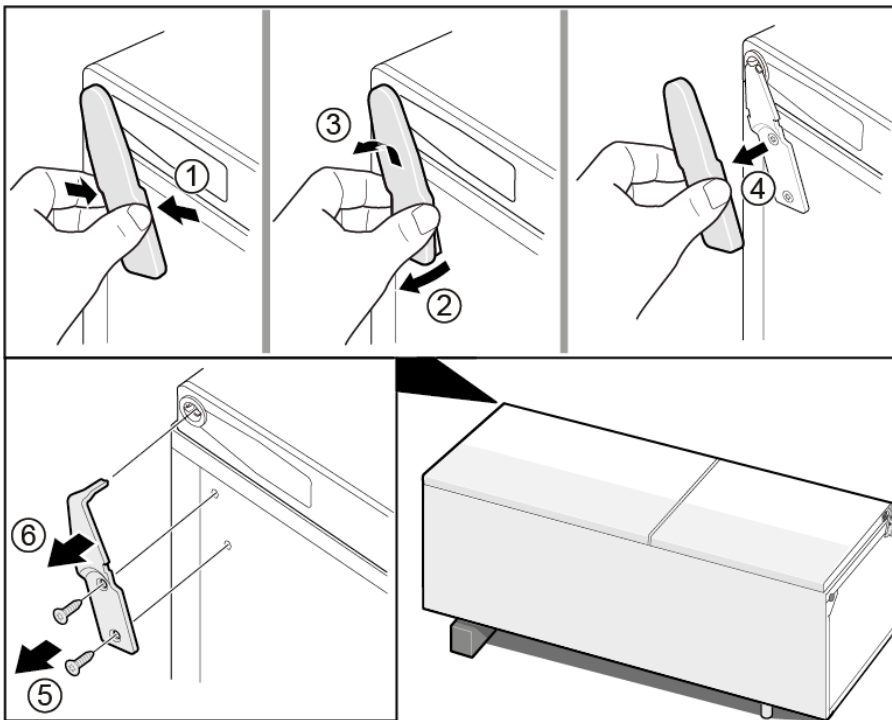

 Horný záves je odobratý.

4.3.2 Montáž horného závesu dvierok

- ▶ Pri montáži postupujte v opačnom poradí krokov demontáže.

4.4 Výmena horného závesu dvierok (dvierka s displejom)

Špeciálne nástroje:

 Bit Torx TX20 6,3 mm (1/4") [00340865]

	VAROVANIE
	<p>Ťažké, objemné spotrebiče! Poranenie chrbta a svalov</p> <ul style="list-style-type: none"> ▶ Proces odoberania dvierok spotrebiča by mal vykonávať školený odborník. ▶ Na presunutie spotrebiča sa vyžadujú dve osoby. ▶ Použite vhodné nástroje a vybavenie.

	UPOZORNENIE
	<p>Ostré hrany! Rezné poranenia</p> <ul style="list-style-type: none"> ▶ Noste ochranné rukavice.

	VAROVANIE
	<p>Zošmyknutie naklonených spotrebičov! Zlomeniny/pomliaždenia</p> <ul style="list-style-type: none"> ▶ Zaistite spotrebiče proti zošmyknutiu.



	UPOZORNENIE
	<p>Riziko pádu dielov po uvoľnení skrutiek! Zranenie padajúcimi dielmi.</p> <ul style="list-style-type: none"> ▶ Zaistite komponent proti pádu.

	POZOR!
	<p>Riziko pádu dielov po uvoľnení skrutiek! Poškodenie iných častí spotrebiča alebo domácnosti zákazníka, napr. podlahy.</p> <ul style="list-style-type: none"> ▶ Zaistite komponent proti pádu.

	NEBEZPEČENSTVO
	<p>Nebezpečenstvo úrazu elektrickým prúdom pri dotyku s časťami pod napätím! Ohrozenie života spôsobené elektrickým zásahom v prípade nesprávnej opravy</p> <ul style="list-style-type: none"> ▶ Elektrické diely má opravovať kvalifikovaný elektrikár. ▶ Po oprave zariadenie vykonanie bezpečnostného testu v súlade s nariadením VDE 0701 alebo s miestnymi nariadeniami.

	NEBEZPEČENSTVO
	<p>Nebezpečenstvo úrazu elektrickým prúdom pri dotyku s časťami pod napätím! Úmrtie v dôsledku zásahu elektrickým prúdom</p> <ul style="list-style-type: none"> ▶ Odpojte spotrebiče od elektrického zdroja aspoň 60 sekúnd pred začiatkom opráv.

Požiadavka:

-  Spotrebič je odpojený od elektrického napájania.
-  Tvarovky z interiéru spotrebiča sú odobraté.

4.4.1 Odoberanie horného závesu dvierok

- Spotrebič dajte na zadnú stranu.

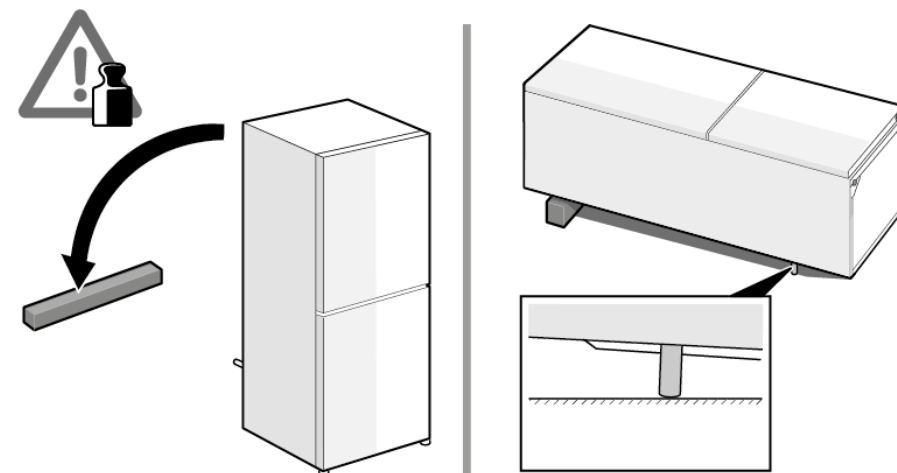

2. 1. Odoberte kryt horného závesu (1).
2. Odoberte kryt priestoru na káble (2).
3. Odpojte elektrické pripojenie (3).
4. Odskrutkujte skrutku uzemňovacieho pripojenia (4).
5. Odoberte ochranu kábla (5).
6. Odskrutkujte skrutku (6)

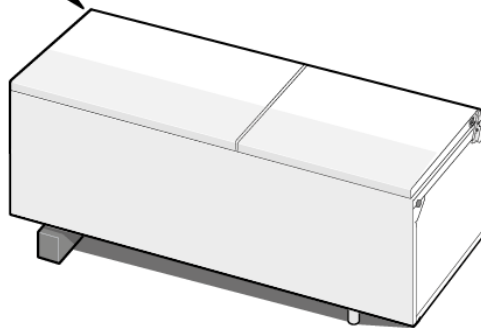
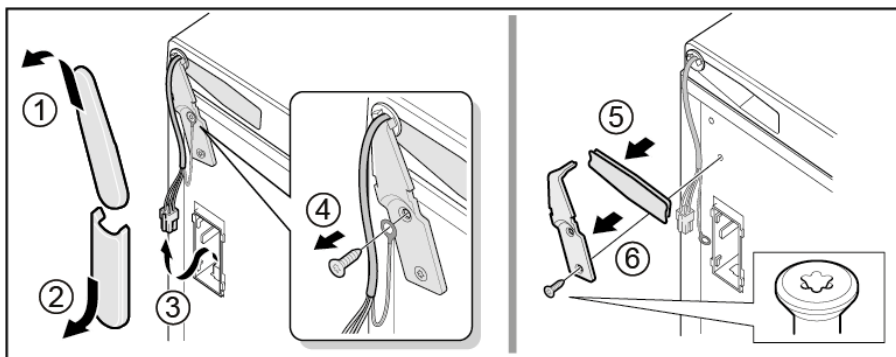

 Horný záves je odobratý.

4.4.2 Montáž horného závesu dverok

- ▶ Pri montáži postupujte v opačnom poradí krokov demontáže.

4.5 Výmena prostredného závesu dverí

Špeciálne nástroje:

 Bit Torx TX20 6,3 mm (1/4") [00340865]

	VAROVANIE
	<p>Ťažké, objemné spotrebiče! Poranenie chrbta a svalov</p> <ul style="list-style-type: none"> ▶ Proces odobrania dvierok spotrebiča by mal vykonávať školený odborník. ▶ Na presunutie spotrebiča sa vyžadujú dve osoby. ▶ Použite vhodné nástroje a vybavenie.



	UPOZORNENIE
	<p>Ostré hrany! Rezné poranenia</p> <ul style="list-style-type: none"> ▶ Noste ochranné rukavice.

	VAROVANIE
	<p>Zošmyknutie naklonených spotrebičov! Zlomeniny/pomliaždenia</p> <ul style="list-style-type: none"> ▶ Zaistite spotrebiče proti zošmyknutiu.

	UPOZORNENIE
	<p>Riziko pádu dielov po uvoľnení skrutiek! Zranenie padajúcimi dielmi.</p> <ul style="list-style-type: none"> ▶ Zaistite komponent proti pádu.

	POZOR!
	<p>Riziko pádu dielov po uvoľnení skrutiek! Poškodenie iných častí spotrebiča alebo domácnosti zákazníka, napr. podlahy.</p> <ul style="list-style-type: none"> ▶ Zaistite komponent proti pádu.

Požiadavka:

-  Spotrebič je odpojený od elektrického napájania.
-  Tvarovky z interiéru spotrebiča sú odobraté.
-  Horný záves dvierok je odobratý.

4.5.1 Odoberanie prostredného závesu dverí

- ▶ 1. Odoberte dvierka z chladiaceho priestoru (1).
- ▶ 2. Odskrutkujte dve skrutky (2).
- ▶ 3. Odoberte prostredný záves (3).

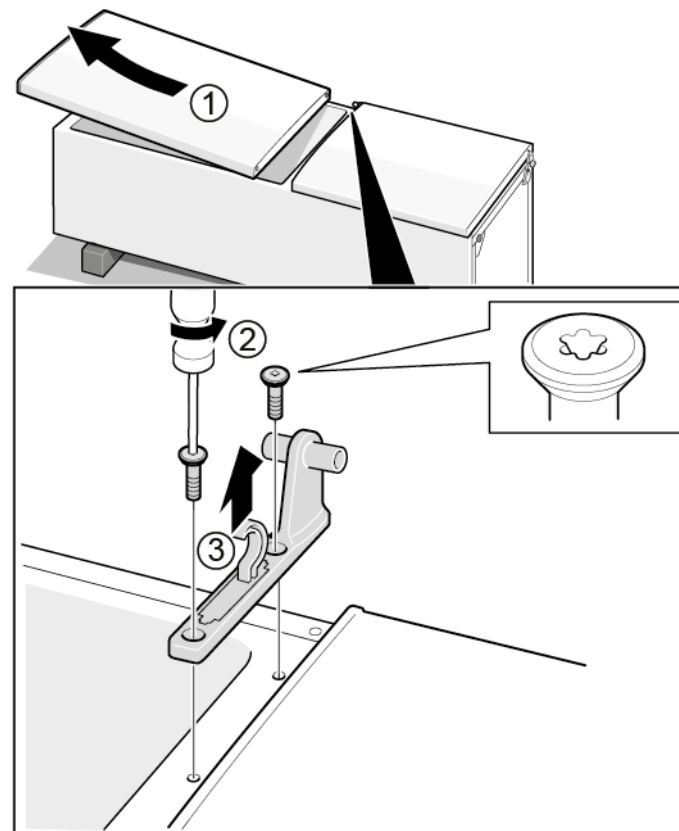

 Prostredný záves je odobratý.

4.5.2 Montáž prostredného závesu dverí

- ▶ Pri montáži postupujte v opačnom poradí krokov demontáže.

4.6 Výmena spodného závesu dvierok

Špeciálne nástroje:

Bit Torx TX20 6,3 mm (1/4") [00340865]

	VAROVANIE
	<p>Ťažké, objemné spotrebiče! Poranenie chrbta a svalov</p> <ul style="list-style-type: none"> ▶ Proces odobrania dvierok spotrebiča by mal vykonávať školený odborník. ▶ Na presunutie spotrebiča sa vyžadujú dve osoby. ▶ Použite vhodné nástroje a vybavenie.

	UPOZORNENIE
	<p>Ostré hrany! Rezné poranenia</p> <ul style="list-style-type: none"> ▶ Noste ochranné rukavice.

	VAROVANIE
	<p>Zošmyknutie naklonených spotrebičov! Zlomeniny/pomliaždenia</p> <ul style="list-style-type: none"> ▶ Zaistite spotrebiče proti zošmyknutiu.

	UPOZORNENIE
	<p>Riziko pádu dielov po uvoľnení skrutiek! Zranenie padajúcimi dielmi.</p> <ul style="list-style-type: none"> ▶ Zaistite komponent proti pádu.

	POZOR!
	<p>Riziko pádu dielov po uvoľnení skrutiek! Poškodenie iných častí spotrebiča alebo domácnosti zákazníka, napr. podlahy.</p> <ul style="list-style-type: none"> ▶ Zaistite komponent proti pádu.

Požiadavka:

- ✔ Spotrebič je odpojený od elektrického napájania.
- ✔ Tvarovky z interiéru spotrebiča sú odobraté.
- ✔ Horný záves je odobratý.

✔ Prostredný záves je odobratý.

4.6.1 Odoberanie spodného závesu dverí

- ▶ 1. Odoberte dverka z mraziaceho priestoru (1).
- ▶ 2. Odskrutkujte skrutku (2).
- ▶ 3. Otočením vyberte spodný záves (3).
- ▶ 4. Odoberte spodný záves (4).

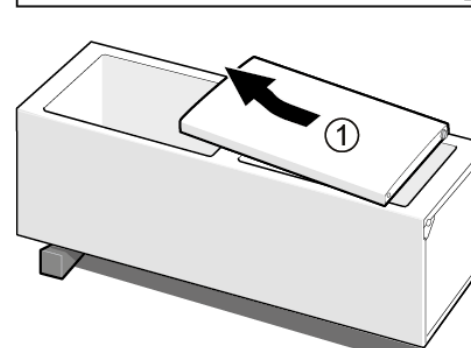
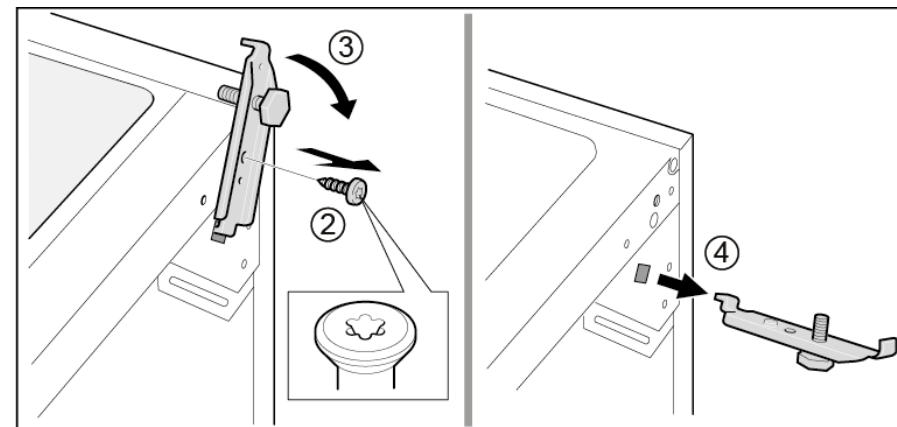

➡ Spodný záves dvierok je odobratý.

4.6.2 Montáž spodného závesu dvierok

- ▶ Pri montáži postupujte v opačnom poradí krokov demontáže.

4.7 Výmena odkladacej plochy

Požiadavka:

- ✔ Dvierka sú otvorené.

4.7.1 Odobratie odkladacej plochy

- ▶ Vytiahnite odkladaciu plochu.

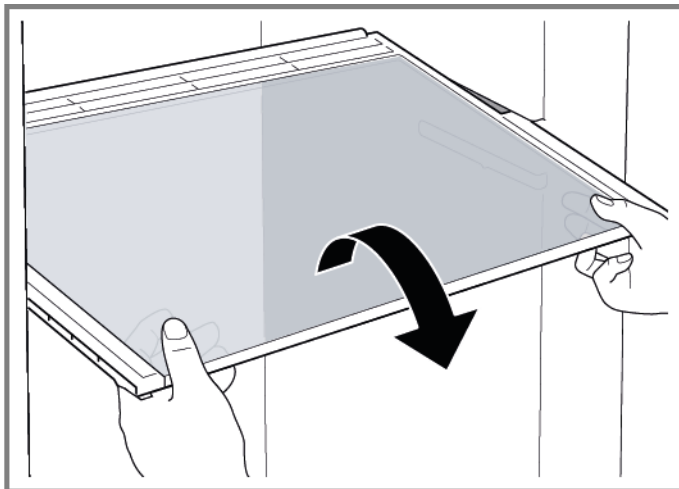

- ➡ Odkladacia plocha je odobratá.

4.7.2 Montáž odkladacej plochy

- ▶ Pri montáži postupujte v opačnom poradí krokov demontáže.

4.8 Výmena odkladacieho priestoru na fľaše

Požiadavka:

- ✔ Dvierka sú otvorené.

4.8.1 Odobratie odkladacieho priestoru na fľaše

- ▶ Vytiahnite odkladací priestor na fľaše.

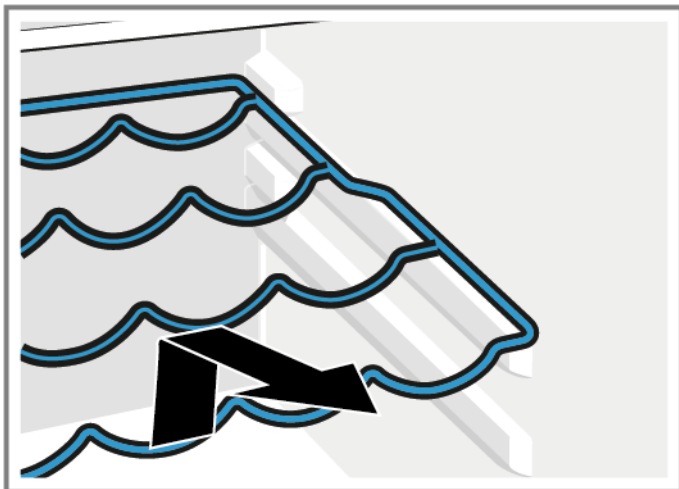

- ➡ Odkladací priestor na fľaše je odobratý.

4.8.2 Montáž odkladacieho priestoru na fľaše

- ▶ Pri montáži postupujte v opačnom poradí krokov demontáže.

4.9 Výmena poličky v dvierkach

Požiadavka:

- ✔ Dvierka sú otvorené.

4.9.1 Odobratie poličky v dvierkach

- ▶ Poličku v dvierkach zodvihnite smerom nahor.

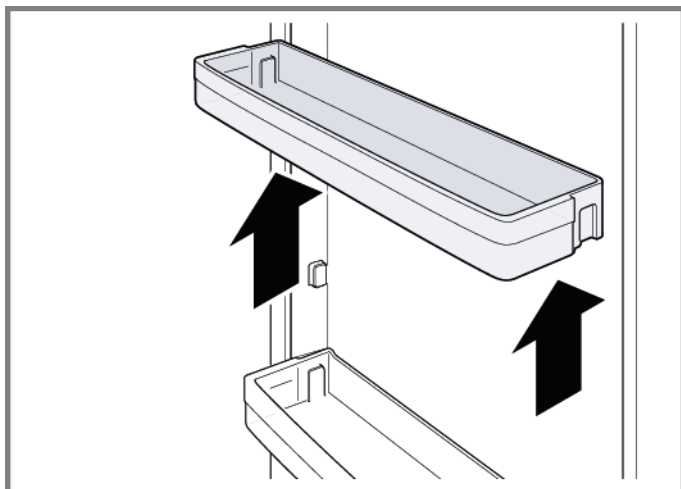

- ➡ Polička v dvierkach je odobratá.

4.9.2 Montáž poličky do dvierok

- ▶ Pri montáži postupujte v opačnom poradí krokov demontáže.

4.10 Výmena nastaviteľnej poličky v dverkach

Požiadavka:

- ✔ Dvierka sú otvorené.

4.10.1 Odobratie nastaviteľnej poličky v dverkach

- ▶ Presuňte výškovo nastaviteľnú poličku v dverkach nahor, aby sa polička uvoľnila z držiaka.

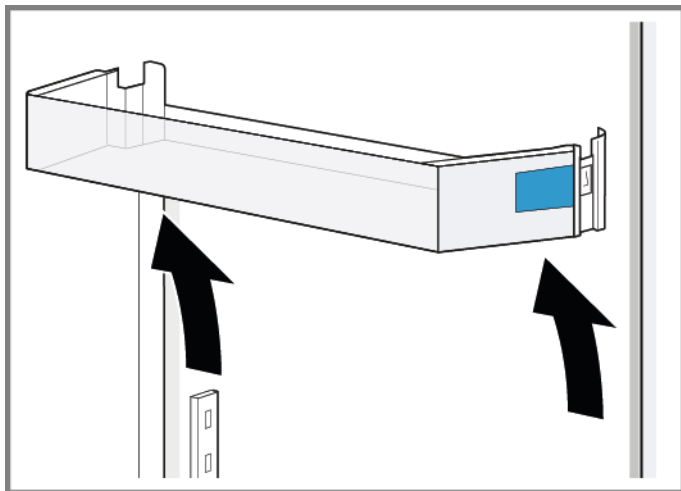

- ➡ Nastaviteľná polička v dverkach je odobratá.

4.10.2 Montáž nastaviteľnej poličky do dvierok

- ▶ Pri montáži postupujte v opačnom poradí krokov demontáže.

4.11 Výmena nádoby na zmrazené potraviny

Požiadavka:

- ✔ Dvierka sú otvorené.

4.11.1 Odobratie nádoby na zmrazené potraviny

- ▶ 1. Úplne vytiahnite nádobu na zmrazené potraviny (1).
- ▶ 2. Odoberte nádobu na varené potraviny (2).

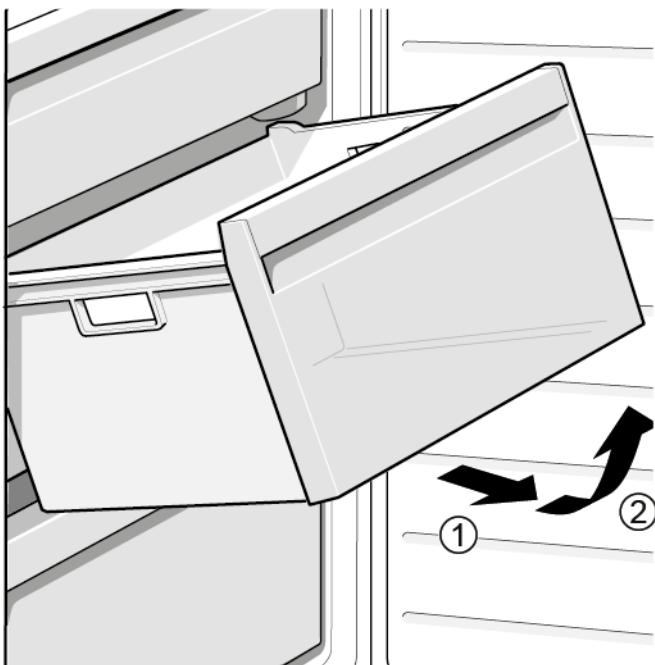

- ➡ Nádobu na zmrazené potraviny je odobratá.

4.11.2 Montáž nádoby na zmrazené potraviny

- ▶ Pri montáži postupujte v opačnom poradí krokov demontáže.

4.12 Výmena nádoby

Požiadavka:

- ✔ Dvierka sú otvorené.

4.12.1 Odobratie nádoby

- ▶ 1. Vyberte spodnú nádobu chladničky (1).
- ▶ 2. Vyberte hornú nádobu chladničky (2).

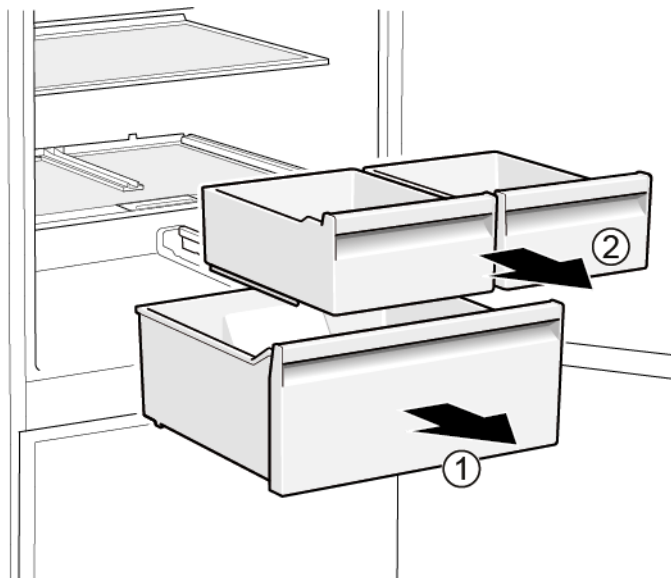

- ➡ Nádoby sú odstránené.

4.12.2 Montáž nádoby

- ▶ Pri montáži postupujte v opačnom poradí krokov demontáže.

4.13 Výmena výsuvnej nádoby

Požiadavka:

- ✔ Dvierka sú otvorené.

4.13.1 Odobratie výsuvnej nádoby

- ▶ 1. Úplne vytiahnite vysúvateľnú nádobu (1).
- ▶ 2. Odoberte výsuvnú nádobu (2).

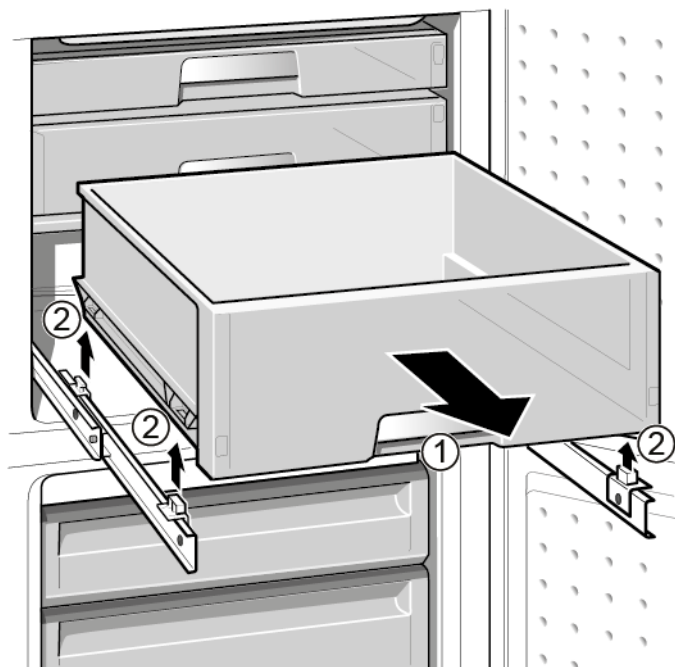

- ➡ Výsuvná nádoba je odobratá.

4.13.2 Montáž výsuvnej nádoby

- ▶ Pri montáži postupujte v opačnom poradí krokov demontáže.

4.14 Výmena bodového LED svetla

Špeciálne nástroje:

 Špeciálny nástroj [00342180]



 Vo výbave vášho spotrebiča je bezúdržbové LED svetlo. Tieto svetlá môže opravovať len zákaznícky servis alebo oprávnený technik!

 **NEBEZPEČENSTVO**
Nebezpečenstvo úrazu elektrickým prúdom pri dotyku s časťami pod napätím!
 Ohrozenie života spôsobené elektrickým zásahom v prípade nesprávnej opravy
 ▶ Elektrické diely má opravovať kvalifikovaný elektrikár.
 ▶ Po oprave zariadenie vykonať bezpečnostného testu v súlade s nariadením VDE 0701 alebo s miestnymi nariadeniami.

 **NEBEZPEČENSTVO**
Nebezpečenstvo úrazu elektrickým prúdom pri dotyku s časťami pod napätím!
 Úmrtie v dôsledku zásahu elektrickým prúdom
 ▶ Odpojte spotrebiče od elektrického zdroja aspoň 60 sekúnd pred začiatkom opráv.

 **UPOZORNENIE**
Ostré hrany!
 Rezné poranenia
 ▶ Noste ochranné rukavice.

Požiadavka:

-  Spotrebič je odpojený od elektrického napájania.
-  Dvierka sú otvorené.

4.14.1 Odoberanie bodového LED svetla

1. Na vytiahnutie bodového LED svetla použite špeciálny nástroj (1).

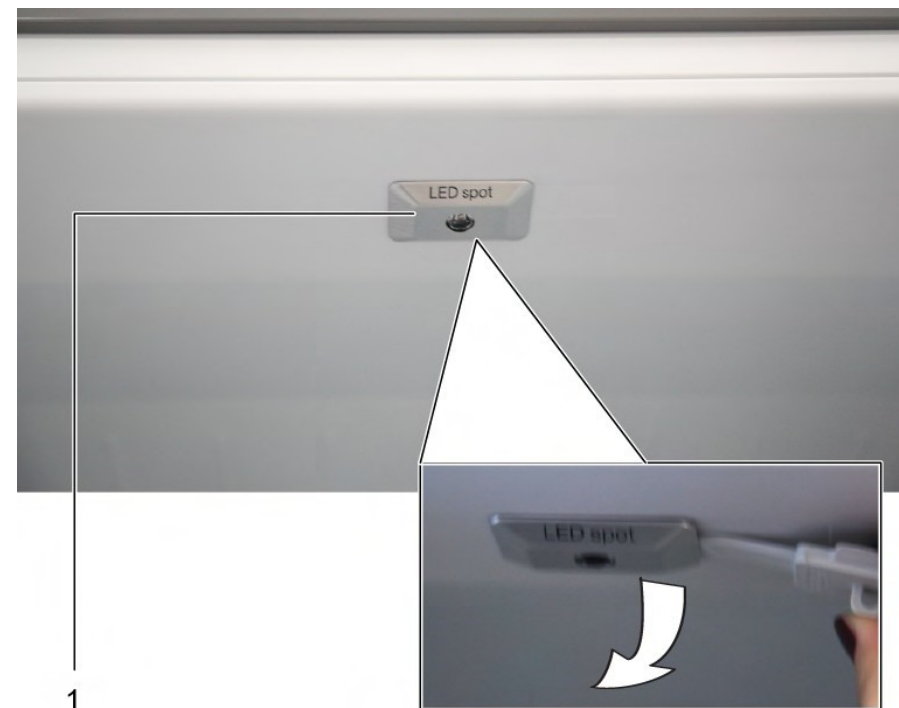

2. Odpojte elektrické pripojenia bodového LED svetla.
-  Bodové LED svetlo je odobraté.

4.14.2 Montáž bodového LED svetla

- ▶ Pri montáži postupujte v opačnom poradí krokov demontáže.

4.15 Výmena horného LED svetla

Špeciálne nástroje:

-  Plochý skrutkovač
- Čepeľ 2,4 mm x 0,4 mm x 60 mm, v sade [00341820]



	Vo výbave vášho spotrebiča je bezúdržbové LED svetlo. Tieto svetlá môže opravovať len zákaznicky servis alebo oprávnený technik!
---	--

	⚠ NEBEZPEČENSTVO
	Nebezpečenstvo úrazu elektrickým prúdom pri dotyku s časťami pod napätím! Ohrozenie života spôsobené elektrickým zásahom v prípade nesprávnej opravy
	<ul style="list-style-type: none"> ▶ Elektrické diely má opravovať kvalifikovaný elektrikár. ▶ Po oprave zariadenie vykonanie bezpečnostného testu v súlade s nariadením VDE 0701 alebo s miestnymi nariadeniami.

	⚠ NEBEZPEČENSTVO
	Nebezpečenstvo úrazu elektrickým prúdom pri dotyku s časťami pod napätím! Úmrtie v dôsledku zásahu elektrickým prúdom
	<ul style="list-style-type: none"> ▶ Odpojte spotrebiče od elektrického zdroja aspoň 60 sekúnd pred začiatkom opráv.

	⚠ UPOZORNENIE
	Ostré hrany! Rezné poranenia
	<ul style="list-style-type: none"> ▶ Noste ochranné rukavice.

Požiadavka:

-  Spotrebič je odpojený od elektrického napájania.
-  Dvierka sú otvorené.
-  Horné tvarovky z interiéru sú odobraté.

4.15.1 Odobratie LED osvetlenia

1. Posuňte LED svetlo na ľavú stranu.



-  Elektrické pripojenie LED svetla je odpojené.

2. Uvoľnite háčiky LED svetla.

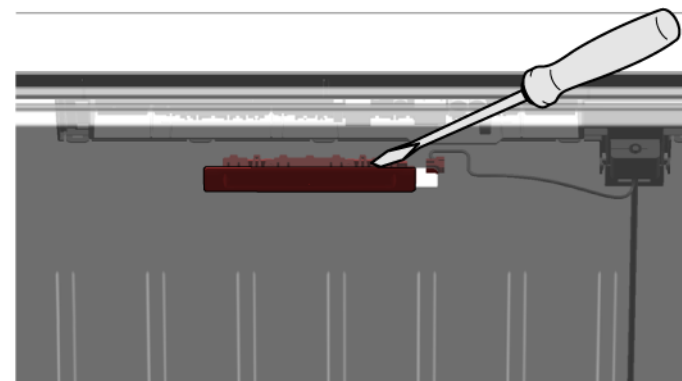

3. Presuňte LED svetlo posunutím dopredu.

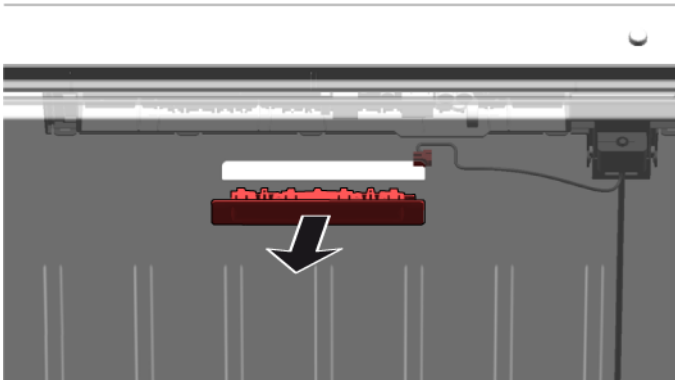

- ➔ LED svetlo je odobraté.

4.15.2 Montáž horného LED svetla

- ▶ Pri montáži postupujte v opačnom poradí krokov demontáže.

4.16 Výmena bočného pásového LED svetla

Špeciálne nástroje:

Prísavný držiak Ø50 mm [00342224]



Vo výbave vášho spotrebiča je bezúdržbové LED svetlo. Tieto svetlá môže opravovať len zákaznícky servis alebo oprávnený technik!



NEBEZPEČENSTVO

Nebezpečenstvo úrazu elektrickým prúdom pri dotyku s časťami pod napätím!
Ohrozenie života spôsobené elektrickým zásahom v prípade nesprávnej opravy

- ▶ Elektrické diely má opravovať kvalifikovaný elektrikár.
- ▶ Po oprave zariadenie vykonať bezpečnostného testu v súlade s nariadením VDE 0701 alebo s miestnymi nariadeniami.



NEBEZPEČENSTVO

Nebezpečenstvo úrazu elektrickým prúdom pri dotyku s časťami pod napätím!

Úmrtie v dôsledku zásahu elektrickým prúdom

- ▶ Odpojte spotrebiče od elektrického zdroja aspoň 60 sekúnd pred začiatkom opráv.



UPOZORNENIE

Ostré hrany!

Rezné poranenia

- ▶ Noste ochranné rukavice.

Požiadavka:

- ✔ Spotrebič je odpojený od elektrického napájania.
- ✔ Dvierka sú otvorené.
- ✔ Poličky chladiaceho priestoru sú odobraté.

4.16.1 Odobratie bočného pásového LED svetla

1. Nalepte prísavný držiak na hornú tretinu bočného pásového LED svetla.



2. Potiahnite prísavný držiak dopredu s bočným pásovým LED svetlom jedným otočným pohybom.

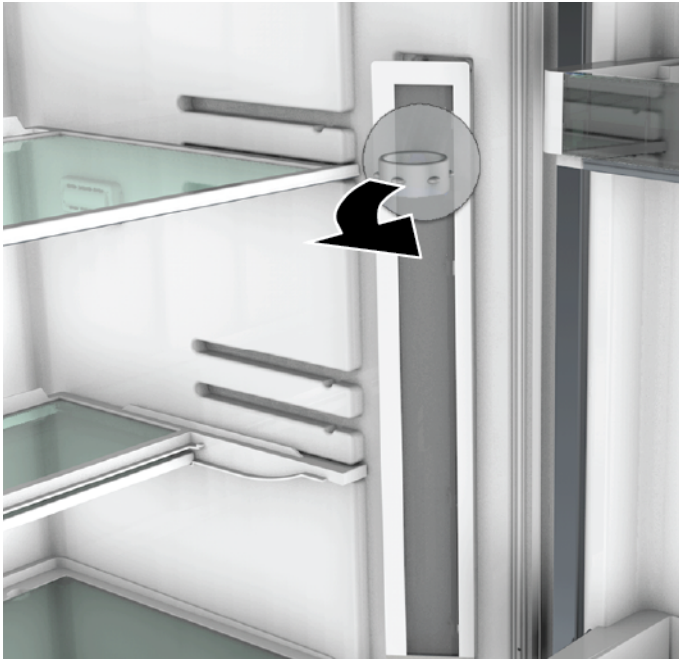

3. Odpojte elektrické pripojenie bočného pásového LED svetla.
➡ Bočné pásové LED svetlo je odobraté.

4.16.2 Montáž bočného pásového LED svetla

1. Pripojte elektrické pripojenie bočného pásového LED svetla.
 2. Pripevnite bočné pásové LED svetlo na svoje miesto na stene priestoru (háčiky zacvaknú).
- ➡ Bočné pásové LED svetlo je namontované.

4.17 Výmena bodového LED svetla

Špeciálne nástroje:

- 🔧 Špeciálny nástroj [00342180]
- 🔧 Plochý skrutkovač Čepel' 2,4 mm x 0,4 mm x 60 mm, v sade [00341820]

i Vo výbave vášho spotrebiča je bezúdržbové LED svetlo. Tieto svetlá môže opravovať len zákaznícky servis alebo oprávnený technik!

⚠ NEBEZPEČENSTVO
Nebezpečenstvo úrazu elektrickým prúdom pri dotyku s časťami pod napätím!
 Ohrozenie života spôsobené elektrickým zásahom v prípade nesprávnej opravy

- ▶ Elektrické diely má opravovať kvalifikovaný elektrikár.
- ▶ Po oprave zariadenie vykonanie bezpečnostného testu v súlade s nariadením VDE 0701 alebo s miestnymi nariadeniami.

⚠ NEBEZPEČENSTVO
Nebezpečenstvo úrazu elektrickým prúdom pri dotyku s časťami pod napätím!
 Úmrtie v dôsledku zásahu elektrickým prúdom

- ▶ Odpojte spotrebiče od elektrického zdroja aspoň 60 sekúnd pred začiatkom opráv.

⚠ UPOZORNENIE
Ostré hrany!
 Rezné poranenia

- ▶ Noste ochranné rukavice.

Požiadavka:

- ✔ Spotrebič je odpojený od elektrického napájania.
- ✔ Dvierka sú otvorené.
- ✔ Poličky chladiaceho priestoru sú odobraté.

4.17.1 Odoberanie bodového LED svetla

1. Uvoľnite kryt bodového LED svetla.

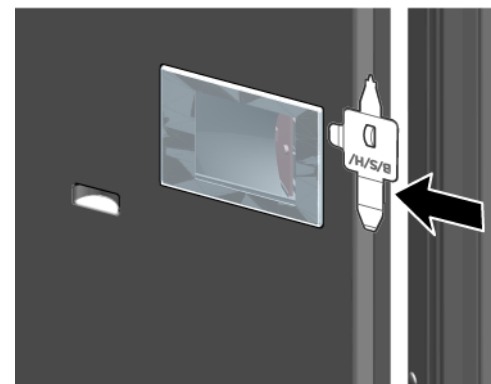

2. Potiahnite kryt bodového LED svetla dovnútra a zároveň zatlačte dopredu.

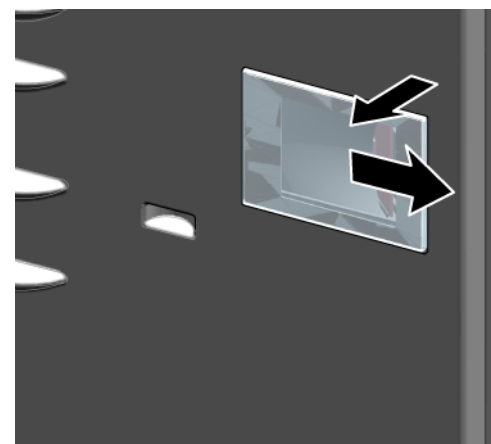

3. Odpojte modul bodového LED svetla.

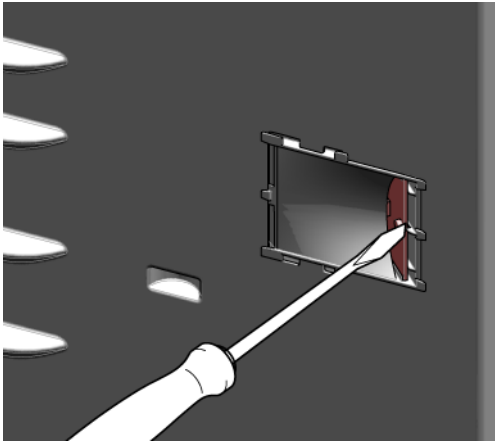

4. Odpojte elektrické pripojenie bodového LED svetla.

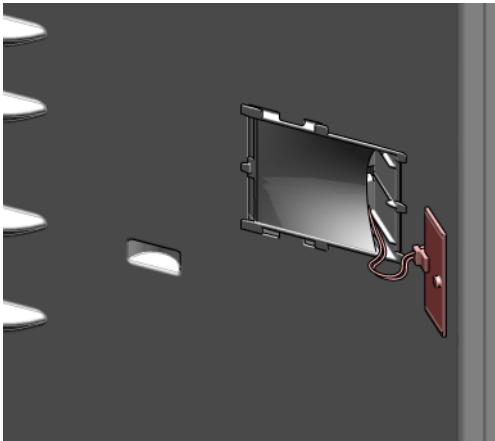





-  Bodové LED svetlo je odobraté.

4.17.2 Montáž bodového LED svetla

- ▶ Pri montáži postupujte v opačnom poradí krokov demontáže.

Nasveti za popravilo - Hladilno-zamrzovalna kombinacija

 V zvezi s tem dokumentom	583		
1.1 Pomembne informacije	583		
1.1.1 Namen	583		
1.2 Razlaga simbolov	583		
1.2.1 Stopnje nevarnosti	583		
1.2.2 Simboli za nevarnost	583		
1.2.3 Struktura opozoril	584		
1.2.4 Splošni simboli	584		
 Varnost.....	585		
2.1 Splošna varnostna navodila	585		
2.1.1 Vsi gospodinjski aparati	585		
 Orodja in pripomočki.....	586		
 Popravilo	587		
4.1 Zamenjava tesnila vrat.....	587		
4.1.1 Odstranjevanje tesnila vrat	587		
4.1.2 Namestitev tesnila vrat	587		
4.2 Zamenjava ročaja vrat	590		
4.2.1 Odstranjevanje ročaja vrat	590		
4.2.2 Namestitev ročaja vrat.....	590		
4.3 Zamenjava zgornjega tečaja vrat.....	591		
4.3.1 Odstranjevanje zgornjega tečaja vrat	591		
4.3.2 Namestitev zgornjega tečaja vrat	592		
4.4 Zamenjava zgornjega tečaja vrat (vrata s prikazovalnikom).....	593		
4.4.1 Odstranjevanje zgornjega tečaja vrat	593		
4.4.2 Namestitev zgornjega tečaja vrat	594		
4.5 Zamenjava srednjega tečaja vrat.....	595		
4.5.1 Odstranjevanje srednjega tečaja vrat	595		
4.5.2 Namestitev srednjega tečaja vrat	595		
4.6 Zamenjava spodnjega tečaja vrat	596		
4.6.1 Odstranjevanje spodnjega tečaja vrat.....	596		
4.6.2 Namestitev spodnjega tečaja vrat	596		
4.7 Zamenjava police	597		
4.7.1 Odstranjevanje police.....	597		
4.7.2 Namestitev police.....	597		
4.8 Zamenjava nosilca za steklenice	598		
4.8.1 Odstranjevanje nosilca za steklenice	598		
4.8.2 Namestitev nosilca za steklenice	598		
4.9 Zamenjava vratnega predala	599		
4.9.1 Odstranjevanje vratnega predala	599		
4.9.2 Namestitev vratnega predala.....	599		
4.10 Zamenjava nastavljivega vratnega predala	600		
4.10.1 Odstranjevanje nastavljivega vratnega predala.....	600		
4.10.2 Namestitev nastavljivega vratnega predala	600		
4.11 Zamenjava predala za zamrznjena živila	601		
4.11.1 Odstranjevanje predala za zamrznjena živila.....	601		
4.11.2 Namestitev predala za zamrznjena živila.....	601		
4.12 Zamenjava predala	602		
4.12.1 Odstranjevanje predala	602		
4.12.2 Namestitev predala.....	602		
4.13 Zamenjava razširljivega predala	603		
4.13.1 Odstranjevanje razširljivega predala	603		
4.13.2 Namestitev razširljivega predala	603		
4.14 Zamenjava točkovne lučke LED	604		
4.14.1 Odstranjevanje točkovne lučke LED	604		
4.14.2 Namestitev točkovne lučke LED	604		
4.15 Zamenjava zgornje lučke LED	605		
4.15.1 Odstranjevanje lučke LED	605		
4.15.2 Namestitev zgornje lučke LED.....	606		
4.16 Zamenjava stranske svetlobne letve LED	607		
4.16.1 Odstranjevanje stranske svetlobne letve LED.....	607		
4.16.2 Namestitev stranske svetlobne letve LED	608		
4.17 Zamenjava točkovne lučke LED	609		
4.17.1 Odstranjevanje točkovne lučke LED	609		
4.17.2 Namestitev točkovne lučke LED	610		

i V zvezi s tem dokumentom

1.1 Pomembne informacije

1.1.1 Namen

Ti namigi za popravila uporabnika podpirajo pri lastnoročnem popravilu aparatov skladno z veljavno direktivo glede okoljsko primerne zasnove (od marca 2021).

Vsebujejo informacije o tem, kako zamenjati določene rezervne dele, vključno z opozorili in tveganji.

Če imate kakšna vprašanja, se obrnite na našo servisno službo. Za škodo bomo odgovorni le, če ste namige za popravila upoštevali pravilno.

1.2 Razlaga simbolov

1.2.1 Stopnje nevarnosti

Stopnje opozoril so sestavljene iz simbola in signalne besede. Signalna beseda označuje stopnjo nevarnosti.





Stopnja opozorila	Pomen
 NEVARNOST	Neupoštevanje opozorilnega sporočila bo povzročilo smrt ali hude poškodbe.
 OPOZORILO	Neupoštevanje opozorilnega sporočila lahko povzroči smrt ali hude poškodbe.
 PREVIDNO	Neupoštevanje opozorilnega sporočila lahko povzroči manjše poškodbe.
 POZOR!	Neupoštevanje opozorilnega sporočila lahko povzroči škodo na lastnini.

Preglednica 1: Stopnje nevarnosti



1.2.2 Simboli za nevarnost

Simboli za nevarnost so simbolni prikazi, ki podajajo informacije o vrsti nevarnosti.

V tem dokumentu so uporabljeni naslednji simboli za nevarnost:

Simbol za nevarnost	Pomen
	Splošno opozorilno sporočilo
	Nevarnost zaradi električne napetosti
	Nevarnost eksplozije
	Nevarnost ureznin
	Nevarnost zmečkanin

i V zvezi s tem dokumentom

Simbol za nevarnost	Pomen
	Nevarnost zaradi vročih površin
	Nevarnost zaradi močnega magnetnega polja
	Nevarnost zaradi neionizirajočega sevanja

Preglednica 2: Simboli za nevarnost

1.2.3 Struktura opozoril

Opozorila v tem dokumentu imajo standardiziran videz in standardizirano strukturo.



	<div style="background-color: red; color: white; padding: 2px; text-align: center;">⚠ NEVARNOST</div> <p>Vrsta in vir nevarnosti! Morebitne posledice ob neupoštevanju nevarnosti/opozorila.</p> <ul style="list-style-type: none"> ▶ Ukrepi in prepovedi za preprečevanje nevarnosti.
--	---





V naslednjem primeru je prikazano opozorilo, ki opozarja pred električnim udarom zaradi delov pod napetostjo. Naveden je ukrep za preprečevanje nevarnosti.

	<div style="background-color: red; color: white; padding: 2px; text-align: center;">⚠ NEVARNOST</div> <p>Nevarnost električnega udara zaradi delov pod napetostjo! Smrt zaradi električnega udara</p> <ul style="list-style-type: none"> ▶ Izključite aparate iz električnega omrežja vsaj 60 sekund pred začetkom popravil.
---	---

1.2.4 Splošni simboli

V tem dokumentu so uporabljeni naslednji splošni simboli:

Splošni simbol	Pomen
	Identifikacija posebnega nasveta (besedilo in/ali slika)
	Identifikacija preprostega nasveta (samo besedilo)
	Identifikacija povezave na video vadnico

Splošni simbol	Pomen
	Identifikacija potrebnih orodij
	Identifikacija potrebnih predpogojev
	Identifikacija pogoja (če ..., potem ...)
	Identifikacija rezultata
Začetek	Identifikacija tipke ali gumba
[00123456]	Identifikacija številke dela
Stanje	Identifikacija prikazanega besedila/okna (na zaslonu aparata)

Preglednica 3: Splošni simboli

2.1 Splošna varnostna navodila

2.1.1 Vsi gospodinjski aparati

Nevarnost električnega udara zaradi delov pod napetostjo!

- Napake zaradi popravil električnih komponent lahko povzročijo električni udar!
- Aparat izključite iz električnega omrežja vsaj 60 sekund pred začetkom del.
- Po popravilu je treba izvesti preizkus varnosti v skladu z VDE 0701 ali predpisi, ki veljajo za posamezno državo.

Nevarnost poškodb zaradi ostrih robov!

- Uporabljajte zaščitne rokavice.

Nevarnost zmečkanin med popravili, vzdrževanjem, odpravljanjem težav ali servisom zaradi težkih in premikajočih se komponent

- Uporabljajte zaščitne čevlje.
- Težke komponente zavarujte pred padanjem.
- Delov telesa ne vstavljajte v premikajoče se komponente.





Tveganje za varnost/delovanje aparata!

- Uporabljajte le originalne nadomestne dele.

Tveganje poškodb elektrostatično občutljivih komponent (ESD)!

- Ne dotikajte se modulov, vključno s povezavami in potmi vodnika.

Orodja in pripomočki

Oznaka	Podrobnosti	Slike
Zaščitna krpa [00342013]	60 cm x 50 cm	
Ploščati izvijač	Steblo 2,4 mm x 0,4 mm x 60 mm, v kompletu [00341820]	
Posebno orodje [00342180]		
Vakuumski prisesek [00342224]	Ø50 mm	
Nastavek Torx TX20 [00340865]	6,3 mm (1/4")	
Ploščati izvijač	Steblo 10 mm x 1,6 mm x 200 mm	

4.1 Zamenjava tesnila vrat

Zahteva:

- ✔ Vrata so odprta.

4.1.1 Odstranjevanje tesnila vrat

1. V levem in desnem kotu sprostite tesnilo vrat iz utora.

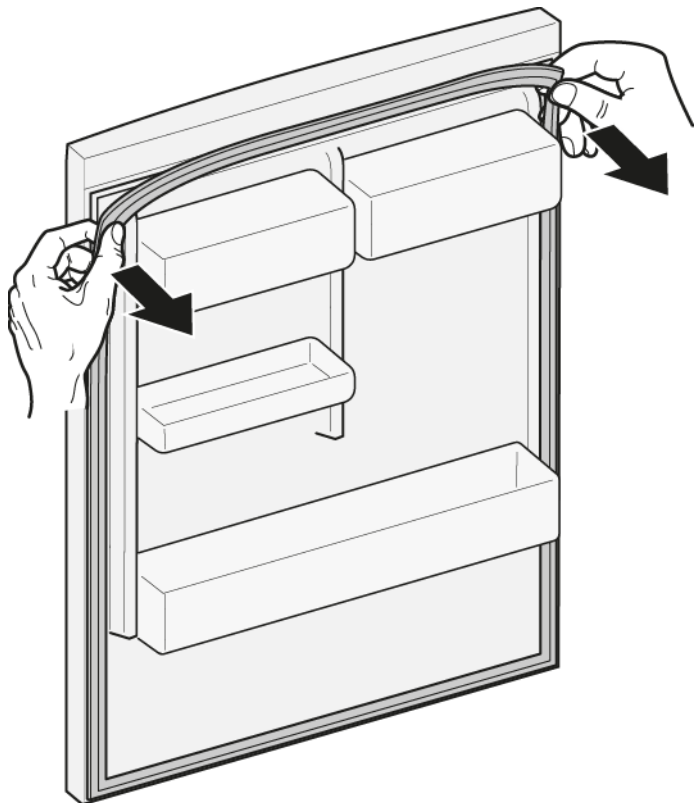



2. Tesnilo vrat izvlecite iz utora.



- ➡ Tesnilo vrat je odstranjeno.

4.1.2 Namestitev tesnila vrat

	Debelina novega tesnila vrat se lahko nekoliko razlikuje od starega tesnila vrat. To ne vpliva na zapiranje in dolgoročno delovanje aparata.
	Če ima aparat nastavljive tečaje ali priključke tečajev, lahko zapiranje naknadno tudi prilagodite.
	Majhne stranske luknje v tesnilu vrat imajo svoj namen (potrebne so za prezračevanje). Ne gre za proizvodne napake.

Popravilo

1. Preverite, ali je utor za tesnilo poškodovan.



4. Vogale tesnila zgoraj in spodaj potisnite v utor.

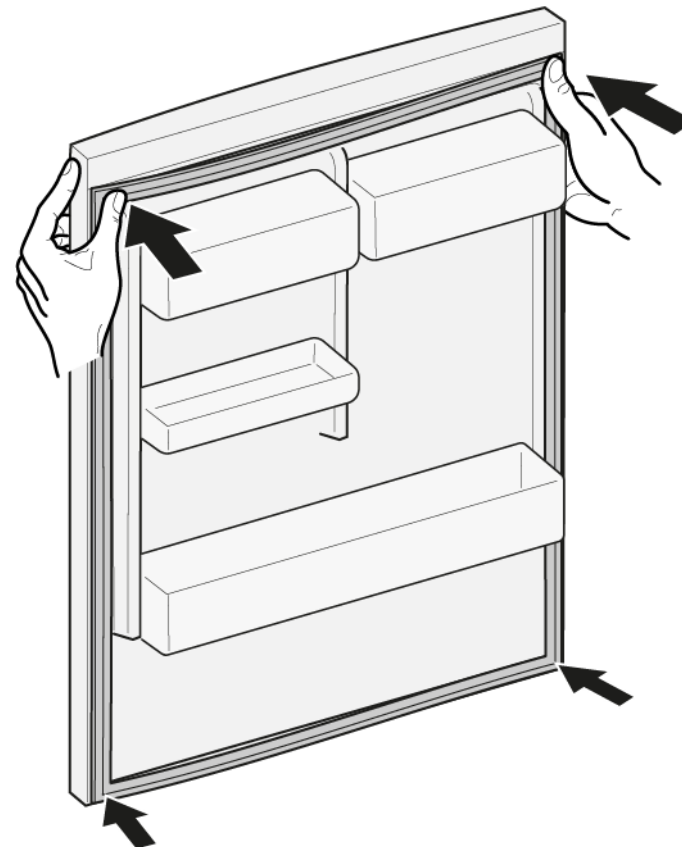

2.  Če je utor za tesnilo poškodovan:
 - se obrnite na našo servisno službo.

3.  Majhna deformacija tesnila vrat je običajna in ne vpliva na njegovo delovanje. Priporočljivo je, da tesnilo vrat pred namestitvijo v aparat poravnate.

Tesnilo vrat lahko segrejete s sušilnikom za lase ali toplo vodo, da ga ročno preoblikujete.

Popravilo

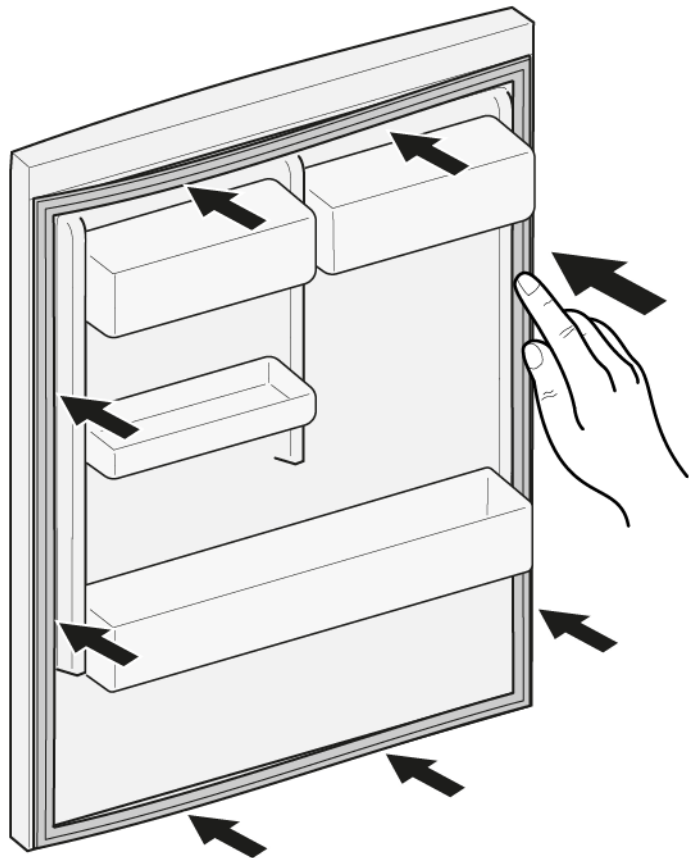

5. Celotno tesnilo korak po koraku potisnite v utor.





 Tesnilo vrat je nameščeno.

4.2 Zamenjava ročaja vrat

Posebna orodja:

-  Nastavek Torx TX20 6,3 mm (1/4") [00340865]
-  Ploščati izvijač Steblo 10 mm x 1,6 mm x 200 mm

Zahteva:

-  Aparat je odklopljen iz omrežne napetosti.
-  Vrata so odprta.

4.2.1 Odstranjevanje ročaja vrat

- ▶ 1. Odstranite dva pokrovčka vijakov (1).
- ▶ 2. Odvijte vijaka (2).
- ▶ 3. Odstranite ročaj vrat (3).

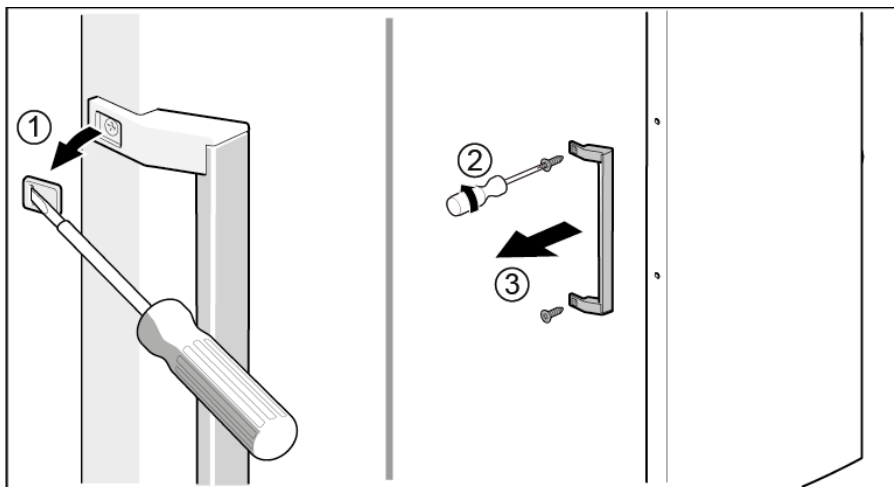

 Ročaj vrat je odstranjen.



Ročaj vrat za druga vrata lahko odstranite na enak način.

4.2.2 Namestitev ročaja vrat

- ▶ Namestite v obratnem vrstnem redu.

4.3 Zamenjava zgornjega tečaja vrat

Posebna orodja:

🌀 Nastavek Torx TX20 6,3 mm (1/4") [00340865]

	<p>⚠️ OPOZORILO</p> <p>Težki, veliki aparati! Poškodbe hrbta in mišic</p> <ul style="list-style-type: none">▶ Postopek odstranjevanja vrat aparata naj izvaja samo pooblašče-no strokovno osebje.▶ Za premikanje aparata sta potrebni dve osebi.▶ Uporabite samo ustrezno orodje in opremo.
--	---

	<p>⚠️ PREVIDNO</p> <p>Ostri robovi! Ureznine</p> <ul style="list-style-type: none">▶ Uporabljajte zaščitne rokavice.
--	--

	<p>⚠️ OPOZORILO</p> <p>Zdrs nagnjenih aparatov! Zlomi kosti/zmečkanine</p> <ul style="list-style-type: none">▶ Aparate zaščitite pred zdrsavanjem.
--	--

	<p>⚠️ PREVIDNO</p> <p>Nevarnost padajočih delov zaradi zrahljanih vijakov! Poškodbe zaradi padajočih delov.</p> <ul style="list-style-type: none">▶ Komponento zaščitite pred padcem.
---	---

	<p>POZOR!</p> <p>Nevarnost padajočih delov zaradi zrahljanih vijakov! Škoda na drugih delih aparata ali pri uporabniku doma, npr. na tleh.</p> <ul style="list-style-type: none">▶ Komponento zaščitite pred padcem.
--	--

Zahteva:

- ✔ Aparat je odklopljen iz omrežne napetosti.
- ✔ Notranji elementi aparata so odstranjeni.

4.3.1 Odstranjevanje zgornjega tečaja vrat

1. Aparat postavite na zadnjo stran.

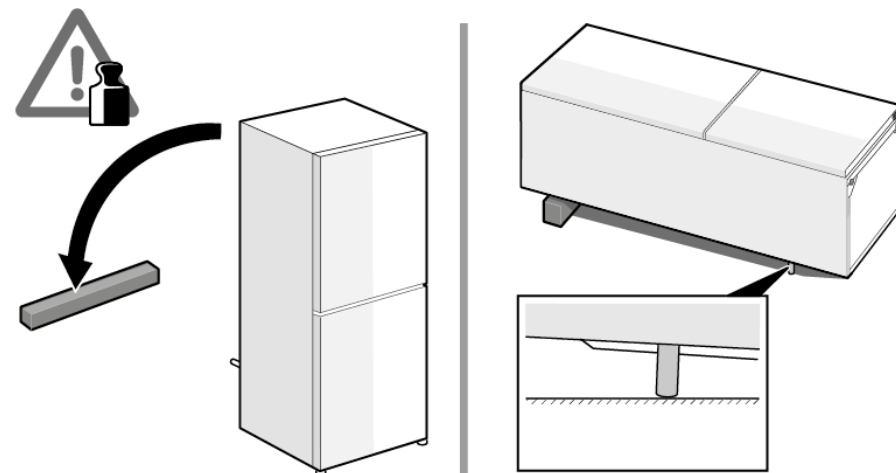

Popravilo

1. Pokrovček zgornjega tečaja pritisnite na obeh straneh (1).
2. Pokrovček zgornjega tečaja povlecite stran (2).
3. Zavrtite pokrovček tečaja (3).
4. Odstranite pokrovček zgornjega tečaja (4).
5. Odvijte vijaka (5).
6. Odstranite zgornji tečaj (6).

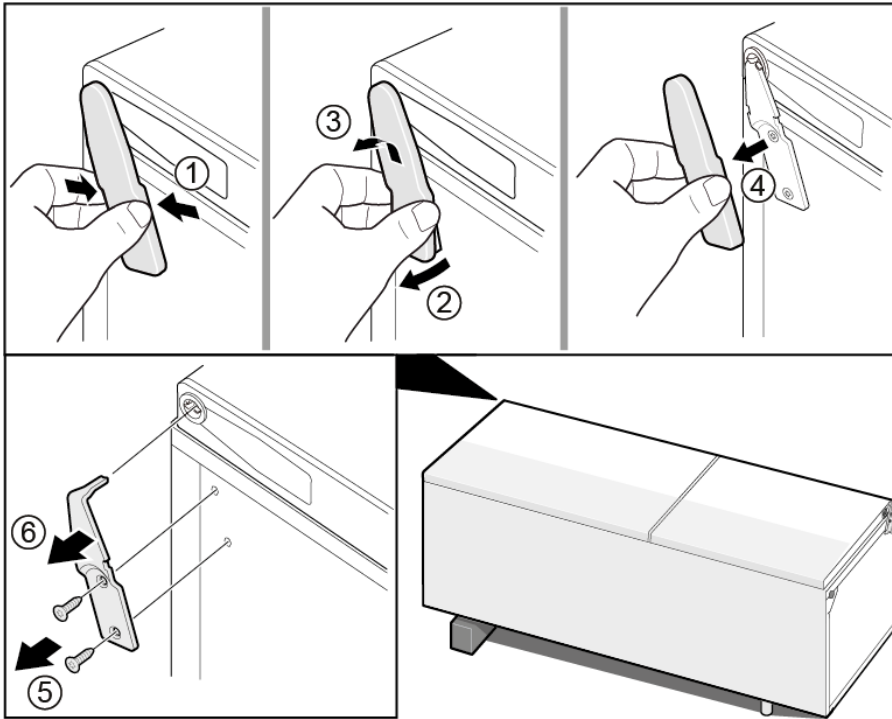

 Zgornji tečaj je odstranjen.

4.3.2 Namestitev zgornjega tečaja vrat

- ▶ Namestite v obratnem vrstnem redu.

4.4 Zamenjava zgornjega tečaja vrat (vrata s prikazovalnikom)

Posebna orodja:

🌀 Nastavek Torx TX20 6,3 mm (1/4") [00340865]

	⚠️ OPOZORILO
	<p>Težki, veliki aparati! Poškodbe hrbta in mišic</p> <ul style="list-style-type: none"> ▶ Postopek odstranjevanja vrat aparata naj izvaja samo pooblaščen strokovno osebje. ▶ Za premikanje aparata sta potrebni dve osebi. ▶ Uporabite samo ustrezno orodje in opremo.

	⚠️ PREVIDNO
	<p>Ostri robovi! Ureznine</p> <ul style="list-style-type: none"> ▶ Uporabljajte zaščitne rokavice.

	⚠️ OPOZORILO
	<p>Zdrs nagnjenih aparatov! Zlomi kosti/zmečkanine</p> <ul style="list-style-type: none"> ▶ Aparate zaščitite pred zdrsavanjem.

	⚠️ PREVIDNO
	<p>Nevarnost padajočih delov zaradi zrahljanih vijakov! Poškodbe zaradi padajočih delov.</p> <ul style="list-style-type: none"> ▶ Komponento zaščitite pred padcem.

	POZOR!
	<p>Nevarnost padajočih delov zaradi zrahljanih vijakov! Škoda na drugih delih aparata ali pri uporabniku doma, npr. na tleh.</p> <ul style="list-style-type: none"> ▶ Komponento zaščitite pred padcem.

	⚠️ NEVARNOST
	<p>Nevarnost električnega udara zaradi delov pod napetostjo! Življenjska nevarnost zaradi električnega udara v primeru nepravilnega popravila</p> <ul style="list-style-type: none"> ▶ Električne dele mora popraviti kvalificiran električar. ▶ Po popravilu je treba izvesti preizkus varnosti v skladu z VDE 0701 ali predpisi, ki veljajo za posamezno državo.

	⚠️ NEVARNOST
	<p>Nevarnost električnega udara zaradi delov pod napetostjo! Smrt zaradi električnega udara</p> <ul style="list-style-type: none"> ▶ Izključite aparate iz električnega omrežja vsaj 60 sekund pred začetkom popravil.

Zahteva:

- ✓ Aparat je odklopljen iz omrežne napetosti.
- ✓ Notranji elementi aparata so odstranjeni.

4.4.1 Odstranjevanje zgornjega tečaja vrat

1. Aparat postavite na zadnjo stran.

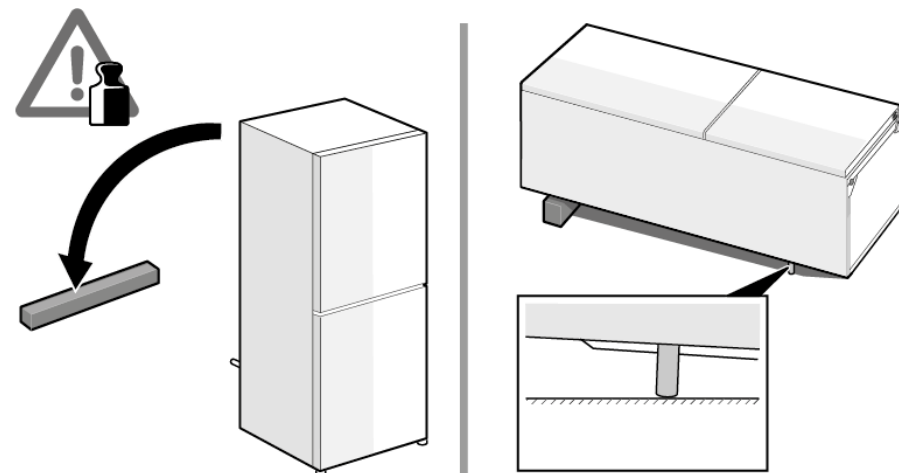

Popravilo

2. 1. Odstranite pokrovček zgornjega tečaja (1).
2. Odstranite pokrovček odprtine za kable (2).
3. Odklopite električno povezavo (3)
4. Odvijte vijak za ozemljitev (4).
5. Odstranite kabelsko zaščito (5).
6. Odvijte vijak (6)

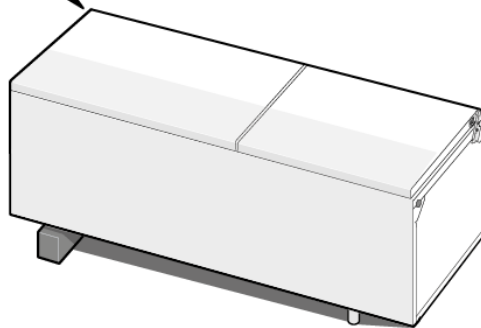
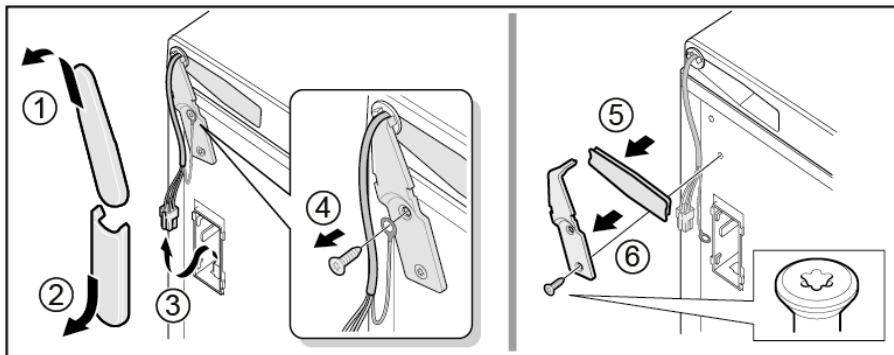

 Zgornji tečaj je odstranjen.

4.4.2 Namestitev zgornjega tečaja vrat

- ▶ Namestite v obratnem vrstnem redu.

4.5 Zamenjava srednjega tečaja vrat

Posebna orodja:

🌀 Nastavek Torx TX20 6,3 mm (1/4") [00340865]

	⚠️ OPOZORILO
Težki, veliki aparati!	
Poškodbe hrbta in mišic	
<ul style="list-style-type: none"> ▶ Postopek odstranjevanja vrat aparata naj izvaja samo pooblašče-no strokovno osebje. ▶ Za premikanje aparata sta potrebni dve osebi. ▶ Uporabite samo ustrezno orodje in opremo. 	

	⚠️ PREVIDNO
Ostri robovi!	
Ureznine	
<ul style="list-style-type: none"> ▶ Uporabljajte zaščitne rokavice. 	

	⚠️ OPOZORILO
Zdrs nagnjenih aparatov!	
Zlomi kosti/zmečkanine	
<ul style="list-style-type: none"> ▶ Aparate zaščitite pred zdrsavanjem. 	

	⚠️ PREVIDNO
Nevarnost padajočih delov zaradi zrahljanih vijakov!	
Poškodbe zaradi padajočih delov.	
<ul style="list-style-type: none"> ▶ Komponento zaščitite pred padcem. 	

	POZOR!
Nevarnost padajočih delov zaradi zrahljanih vijakov!	
Škoda na drugih delih aparata ali pri uporabniku doma, npr. na tleh.	
<ul style="list-style-type: none"> ▶ Komponento zaščitite pred padcem. 	

Zahteva:

- ✔️ Aparat je odklopljen iz omrežne napetosti.
- ✔️ Notranji elementi aparata so odstranjeni.
- ✔️ Zgornji tečaj vrat je odstranjen.

4.5.1 Odstranjevanje srednjega tečaja vrat

- ▶ 1. Odstranite vrata hladilnega dela (1).
- ▶ 2. Odvijte vijaka (2).
- ▶ 3. Odstranite srednji tečaj (3).

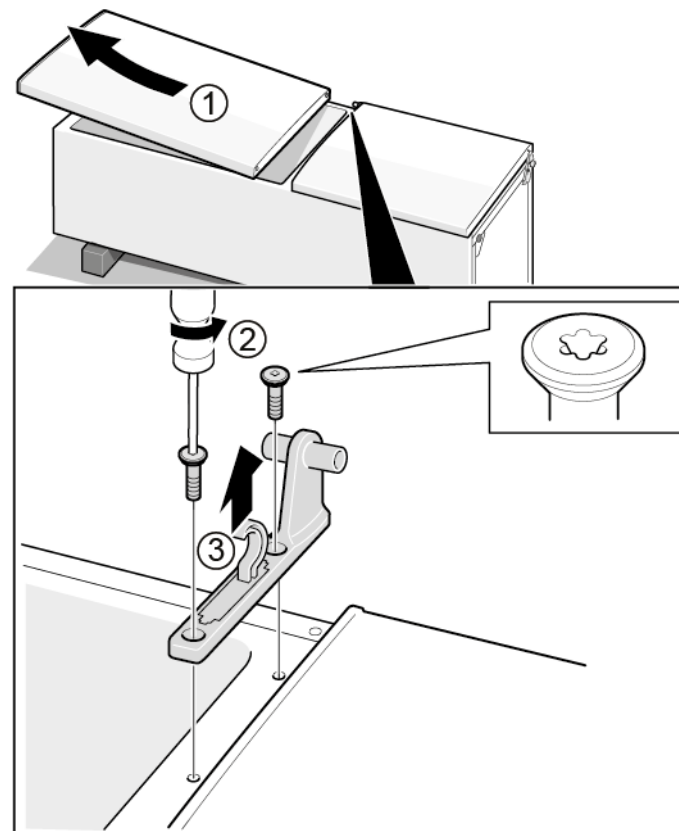

➡ Srednji tečaj je odstranjen.

4.5.2 Namestitev srednjega tečaja vrat

- ▶ Namestite v obratnem vrstnem redu.

4.6 Zamenjava spodnjega tečaja vrat

Posebna orodja:

🌀 Nastavek Torx TX20 6,3 mm (1/4") [00340865]

	⚠️ OPOZORILO
Težki, veliki aparati!	
Poškodbe hrbta in mišic	
<ul style="list-style-type: none"> ▶ Postopek odstranjevanja vrat aparata naj izvaja samo pooblašče-no strokovno osebje. ▶ Za premikanje aparata sta potrebni dve osebi. ▶ Uporabite samo ustrezno orodje in opremo. 	

	⚠️ PREVIDNO
Ostri robovi!	
Ureznine	
<ul style="list-style-type: none"> ▶ Uporablajte zaščitne rokavice. 	

	⚠️ OPOZORILO
Zdrs nagnjenih aparatov!	
Zlomi kosti/zmečkanine	
<ul style="list-style-type: none"> ▶ Aparate zaščitite pred zdrsavanjem. 	

	⚠️ PREVIDNO
Nevarnost padajočih delov zaradi zrahljanih vijakov!	
Poškodbe zaradi padajočih delov.	
<ul style="list-style-type: none"> ▶ Komponento zaščitite pred padcem. 	

	POZOR!
Nevarnost padajočih delov zaradi zrahljanih vijakov!	
Škoda na drugih delih aparata ali pri uporabniku doma, npr. na tleh.	
<ul style="list-style-type: none"> ▶ Komponento zaščitite pred padcem. 	

Zahteva:

- ✔️ Aparat je odklopljen iz omrežne napetosti.
- ✔️ Notranji elementi aparata so odstranjeni.
- ✔️ Zgornji tečaj je odstranjen.
- ✔️ Srednji tečaj je odstranjen.

4.6.1 Odstranjevanje spodnjega tečaja vrat

- ▶ 1. Odstranite vrata zamrzovalnega dela (1).
- ▶ 2. Odvijte vijak (2).
- ▶ 3. Spodnji tečaj zavrtite navzven (3).
- ▶ 4. Odstranite spodnji tečaj (4).

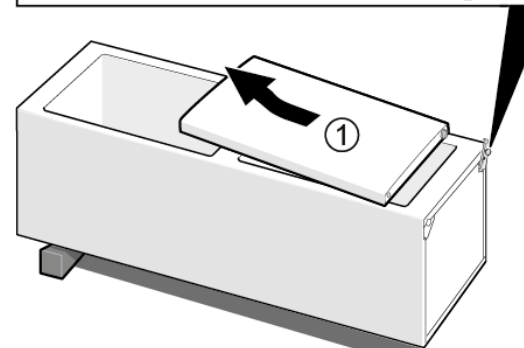
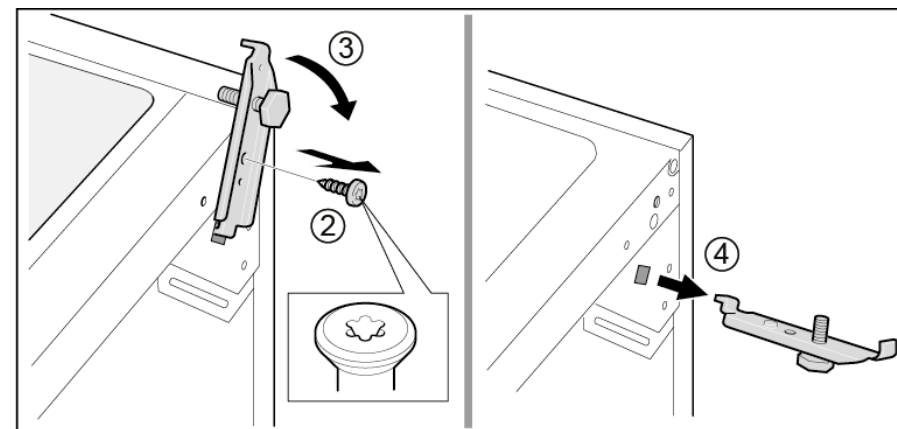

- ➡ Spodnji tečaj vrat je odstranjen.

4.6.2 Namestitev spodnjega tečaja vrat

- ▶ Namestite v obratnem vrstnem redu.

4.7 Zamenjava police

Zahteva:

- ✔ Vrata so odprta.

4.7.1 Odstranjevanje police

- ▶ Izvlecite polico.

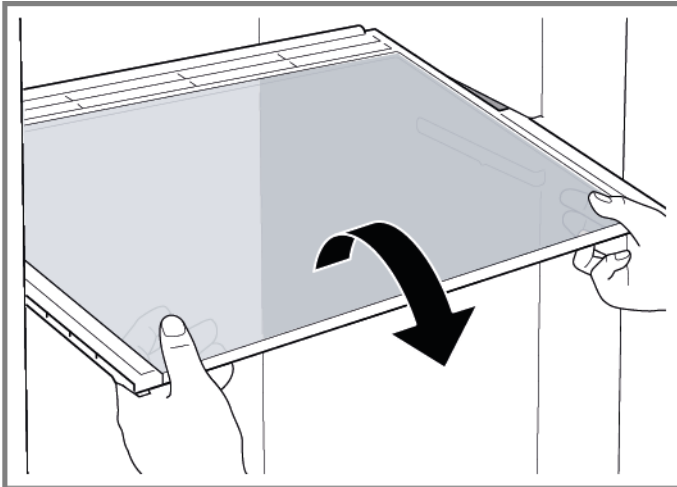

- ➡ Polica je odstranjena.

4.7.2 Namestitev police

- ▶ Namestite v obratnem vrstnem redu.

4.8 Zamenjava nosilca za steklenice

Zahteva:

- ✔ Vrata so odprta.

4.8.1 Odstranjevanje nosilca za steklenice

- ▶ Izvlecite nosilec za steklenice.

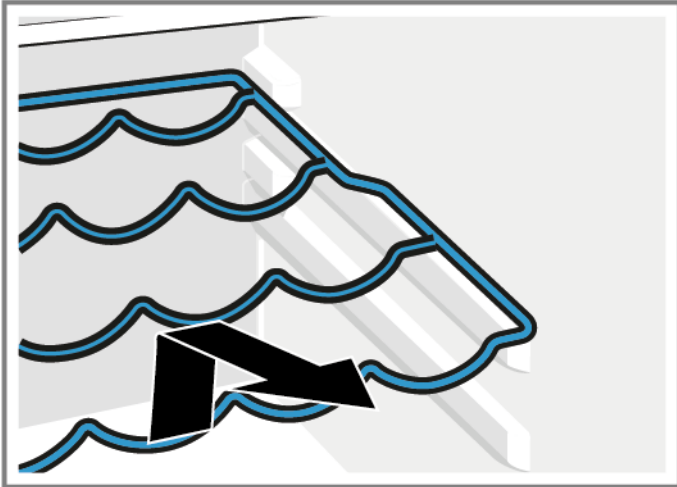

- ➔ Nosilec za steklenice je odstranjen.

4.8.2 Namestitev nosilca za steklenice

- ▶ Namestite v obratnem vrstnem redu.

4.9 Zamenjava vratnega predala

Zahteva:

- ✔ Vrata so odprta.

4.9.1 Odstranjevanje vratnega predala

- ▶ Dvignite vrtni predal navzgor.

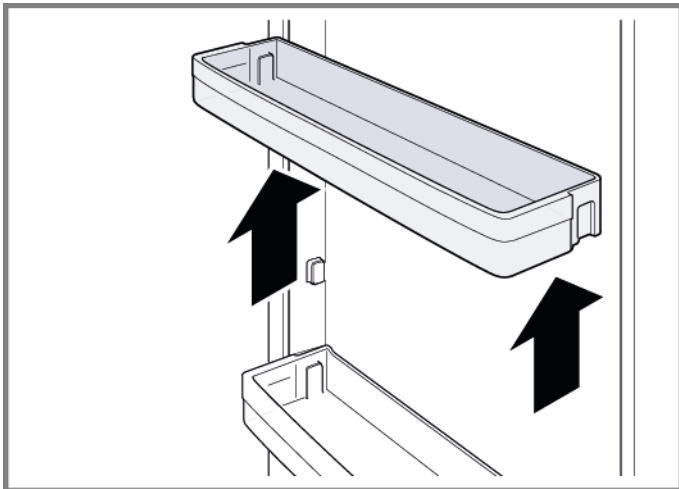

➡ Vratni predal je odstranjen.

4.9.2 Namestitev vratnega predala

- ▶ Namestite v obratnem vrstnem redu.

4.10 Zamenjava nastavljivega vratnega predala

Zahteva:

- ✔ Vrata so odprta.

4.10.1 Odstranjevanje nastavljivega vratnega predala

- ▶ Vratni predal, nastavljen po višini, pomikajte navzgor, dokler se ne sprosti iz držala.

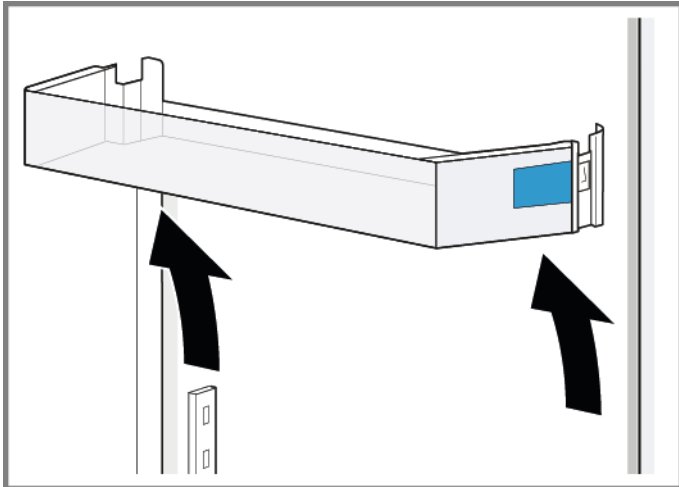

- ➡ Nastavljen vratni predal je odstranjen.

4.10.2 Namestitev nastavljivega vratnega predala

- ▶ Namestite v obratnem vrstnem redu.

4.11 Zamenjava predala za zamrznjena živila

Zahteva:

- ✔ Vrata so odprta.

4.11.1 Odstranjevanje predala za zamrznjena živila

- ▶ 1. Predal za zamrznjena živila izvlecite do konca (1).
- ▶ 2. Odstranite predal za živila (2).

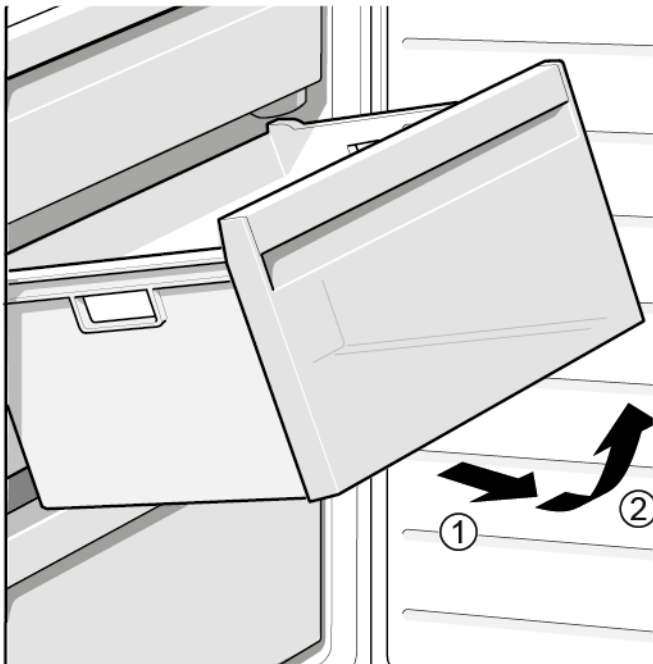

- ➡ Predal za zamrznjena živila je odstranjen.

4.11.2 Namestitev predala za zamrznjena živila

- ▶ Namestite v obratnem vrstnem redu.

4.12 Zamenjava predala

Zahteva:

- ✔ Vrata so odprta.

4.12.1 Odstranjanje predala

- ▶ 1. Izvlecite spodnji predal hladilnika (1).
- ▶ 2. Izvlecite zgornji predal hladilnika (2).

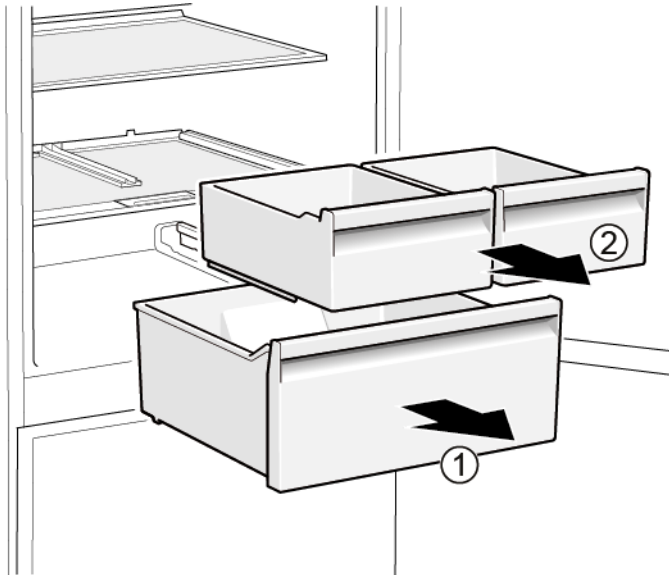

- ➡ Predala sta odstranjena.

4.12.2 Namestitev predala

- ▶ Namestite v obratnem vrstnem redu.

4.13 Zamenjava razširljivega predala

Zahteva:

- ✔ Vrata so odprta.

4.13.1 Odstranjevanje razširljivega predala

- ▶ 1. Razširljivi predal izvlecite do konca (1).
- ▶ 2. Odstranite razširljivi predal (2).

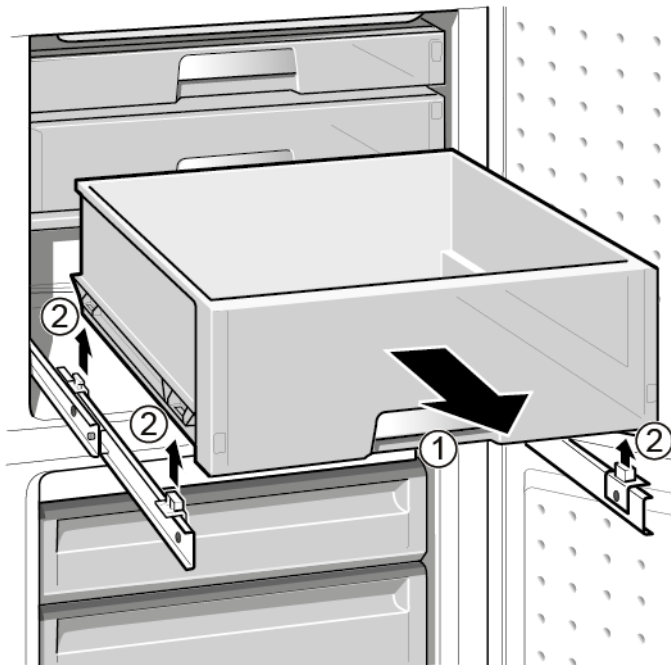

- ➡ Razširljivi predal je odstranjen.

4.13.2 Namestitev razširljivega predala

- ▶ Namestite v obratnem vrstnem redu.

4.14 Zamenjava točkovne lučke LED

Posebna orodja:

🔧 Posebno orodje [00342180]



Vaš aparat je opremljen z osvetlitvijo LED, ki ne potrebuje vzdrževanja. To vrsto osvetlitve lahko popravi samo servisna služba ali pooblaščen strokovno osebje!



⚠️ NEVARNOST

Nevarnost električnega udara zaradi delov pod napetostjo!

Življenjska nevarnost zaradi električnega udara v primeru nepravilnega popravila

- ▶ Električne dele mora popraviti kvalificiran električar.
- ▶ Po popravilu je treba izvesti preizkus varnosti v skladu z VDE 0701 ali predpisi, ki veljajo za posamezno državo.



⚠️ NEVARNOST

Nevarnost električnega udara zaradi delov pod napetostjo!

Smrt zaradi električnega udara

- ▶ Izključite aparate iz električnega omrežja vsaj 60 sekund pred začetkom popravil.



⚠️ PREVIDNO

Ostri robovi!

Ureznine

- ▶ Uporabljajte zaščitne rokavice.

Zahteva:

- ✔ Aparat je odklopljen iz omrežne napetosti.
- ✔ Vrata so odprta.

4.14.1 Odstranjevanje točkovne lučke LED

1. Točkovno lučko LED izvalcite s posebnim orodjem (1).

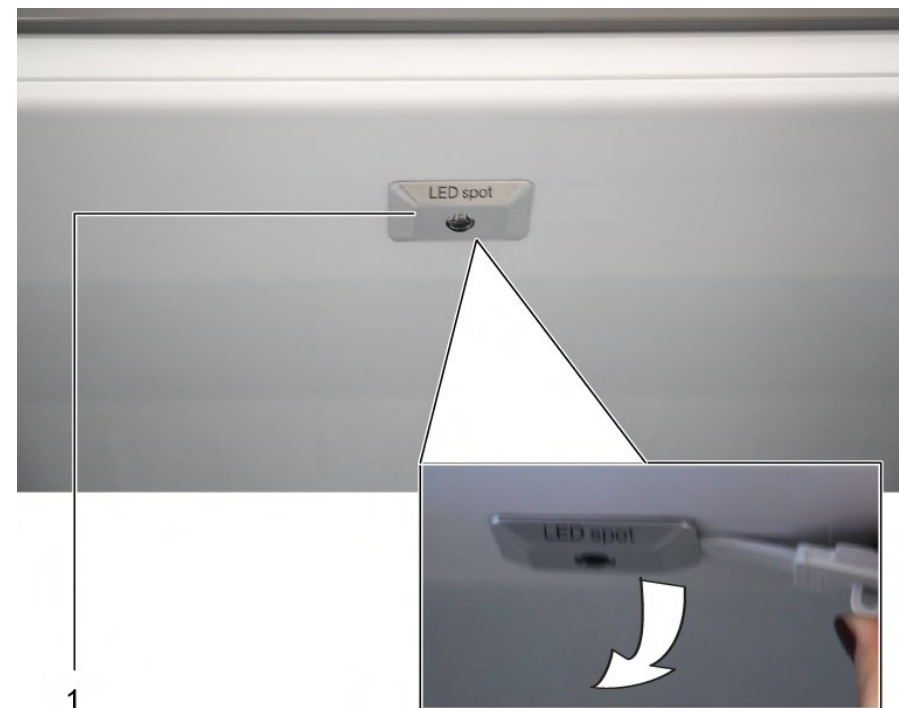

2. Odklopite električne priključke točkovne lučke LED.
- ➡ Točkovna lučka LED je odstranjena.

4.14.2 Namestitev točkovne lučke LED

- ▶ Namestite v obratnem vrstnem redu.

4.15 Zamenjava zgornje lučke LED

Posebna orodja:

🔗 Ploščati izvijač

Steblo 2,4 mm x 0,4 mm x 60 mm, v kompletu [00341820]



Vaš aparat je opremljen z osvetlitvijo LED, ki ne potrebuje vzdrževanja. To vrsto osvetlitve lahko popravi samo servisna služba ali pooblaščen strokovno osebje!



⚠️ NEVARNOST

Nevarnost električnega udara zaradi delov pod napetostjo!

Življenjska nevarnost zaradi električnega udara v primeru nepravilnega popravila

- ▶ Električne dele mora popraviti kvalificiran električar.
- ▶ Po popravilu je treba izvesti preizkus varnosti v skladu z VDE 0701 ali predpisi, ki veljajo za posamezno državo.



⚠️ NEVARNOST

Nevarnost električnega udara zaradi delov pod napetostjo!

Smrt zaradi električnega udara

- ▶ Izključite aparate iz električnega omrežja vsaj 60 sekund pred začetkom popravil.



⚠️ PREVIDNO

Ostri robovi!

Ureznine

- ▶ Uporabljajte zaščitne rokavice.

Zahteva:

- ✔️ Aparat je odklopljen iz omrežne napetosti.
- ✔️ Vrata so odprta.
- ✔️ Odstranjeni so zgornji notranji elementi aparata.

4.15.1 Odstranjevanje lučke LED

1. Lučko LED premaknite v levo.

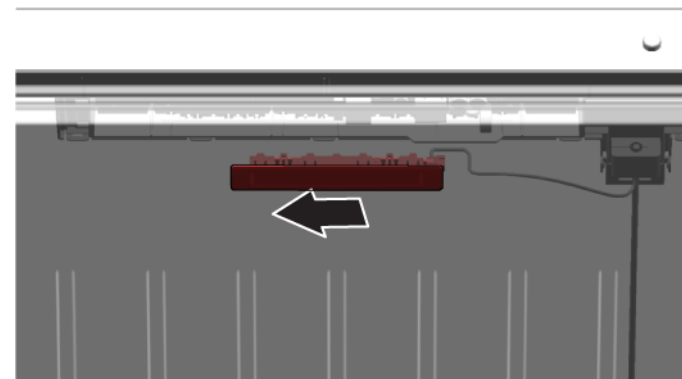

- ➡️ Električni priključek lučke LED je odklopljen.

2. Sprostite zatiče lučke LED.

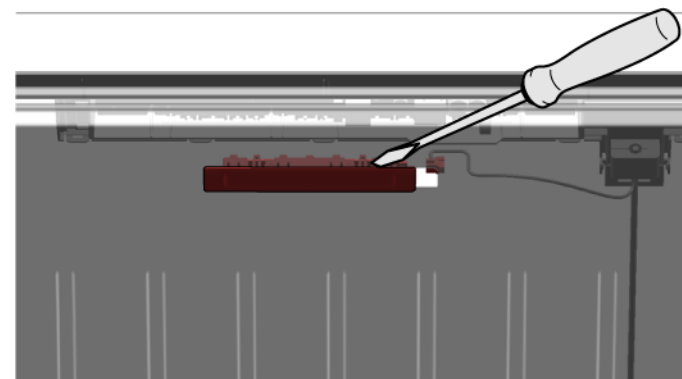

Popravilo

3. Lučko LED premaknite naprej in jo odstranite.

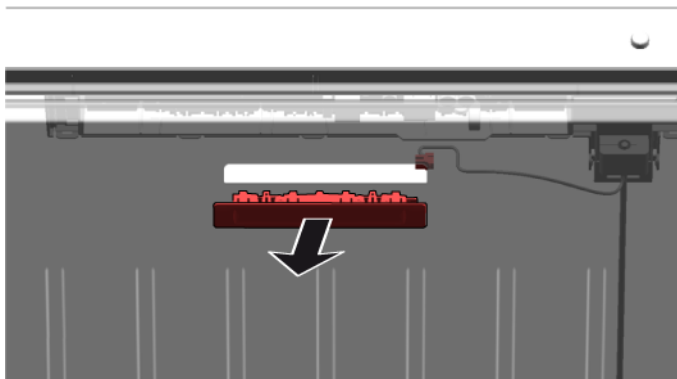

- ➡ Lučka LED je odstranjena.

4.15.2 Namestitev zgornje lučke LED

- ▶ Namestite v obratnem vrstnem redu.

4.16 Zamenjava stranske svetlobne letve LED

Posebna orodja:

 Vakuumski prisesek Ø50 mm [00342224]



Vaš aparat je opremljen z osvetlitvijo LED, ki ne potrebuje vzdrževanja. To vrsto osvetlitve lahko popravi samo servisna služba ali pooblaščen strokovno osebje!



NEVARNOST

Nevarnost električnega udara zaradi delov pod napetostjo!

Življenjska nevarnost zaradi električnega udara v primeru nepravilnega popravila

- ▶ Električne dele mora popraviti kvalificiran električar.
- ▶ Po popravilu je treba izvesti preizkus varnosti v skladu z VDE 0701 ali predpisi, ki veljajo za posamezno državo.



NEVARNOST

Nevarnost električnega udara zaradi delov pod napetostjo!

Smrt zaradi električnega udara

- ▶ Izključite aparate iz električnega omrežja vsaj 60 sekund pred začetkom popravil.





PREVIDNO

Ostri robovi!

Ureznine

- ▶ Uporabljajte zaščitne rokavice.

Zahteva:

-  Aparat je odklopljen iz omrežne napetosti.
-  Vrata so odprta.
-  Police hladilnega dela so odstranjene.

4.16.1 Odstranjevanje stranske svetlobne letve LED

1. Prisesek namestite na zgornjo tretjino stranske svetlobne letve LED.



Popravilo

2. S krožnim gibom povlecite prisesek s stransko svetlobno letvijo LED k sebi.

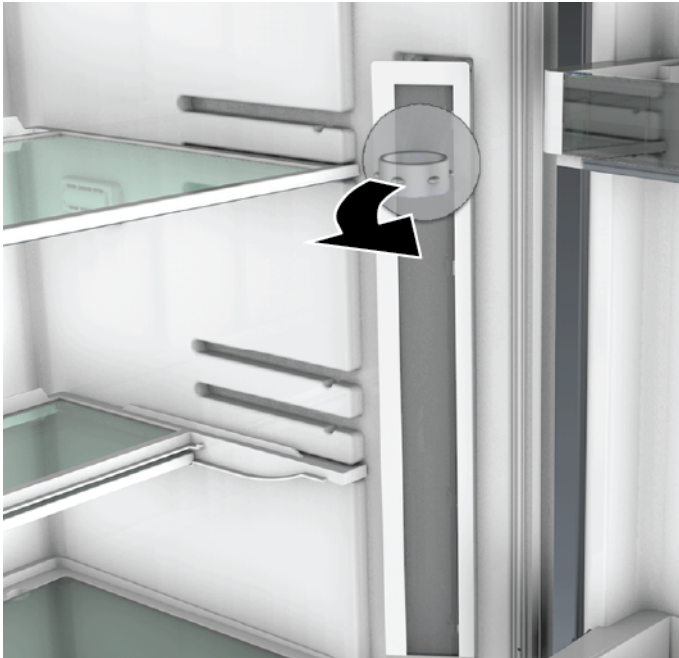

3. Odklopite električno povezavo stranske svetlobne letve LED.
➡ Stranska svetlobna letev LED je odstranjena.

4.16.2 Namestitev stranske svetlobne letve LED

1. Priključite električno povezavo stranske svetlobne letve LED.
 2. Stransko svetlobno letev LED pritrdite na njeno mesto na steni hladilnika (zatiči se zaskočijo).
- ➡ Stranska svetlobna letev LED je nameščena.

4.17 Zamenjava točkovne lučke LED

Posebna orodja:

- 🔧 Posebno orodje [00342180]
- 🔧 Ploščati izvijač Steblo 2,4 mm x 0,4 mm x 60 mm, v kompletu [00341820]



Vaš aparat je opremljen z osvetlitvijo LED, ki ne potrebuje vzdrževanja. To vrsto osvetlitve lahko popravi samo servisna služba ali pooblaščen strokovno osebje!



⚠️ NEVARNOST

Nevarnost električnega udara zaradi delov pod napetostjo!

Življenjska nevarnost zaradi električnega udara v primeru nepravilnega popravila

- ▶ Električne dele mora popraviti kvalificiran električar.
- ▶ Po popravilu je treba izvesti preizkus varnosti v skladu z VDE 0701 ali predpisi, ki veljajo za posamezno državo.



⚠️ NEVARNOST

Nevarnost električnega udara zaradi delov pod napetostjo!

Smrt zaradi električnega udara

- ▶ Izključite aparate iz električnega omrežja vsaj 60 sekund pred začetkom popravil.



⚠️ PREVIDNO

Ostri robovi!

Ureznine

- ▶ Uporabljajte zaščitne rokavice.

Zahteva:

- ✔️ Aparat je odklopljen iz omrežne napetosti.
- ✔️ Vrata so odprta.
- ✔️ Police hladilnega dela so odstranjene.

4.17.1 Odstranjevanje točkovne lučke LED

1. Sprostite pokrovček točkovne lučke LED.

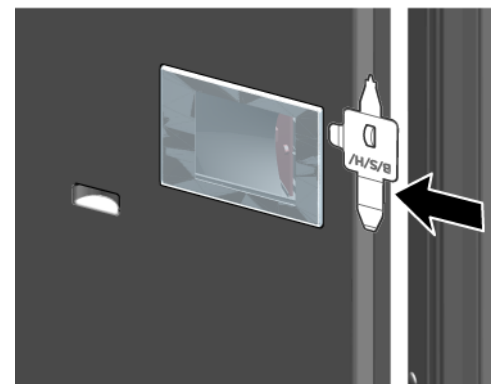

2. Pokrovček točkovne lučke LED povlecite navznoter in ga hkrati potisnite naprej.

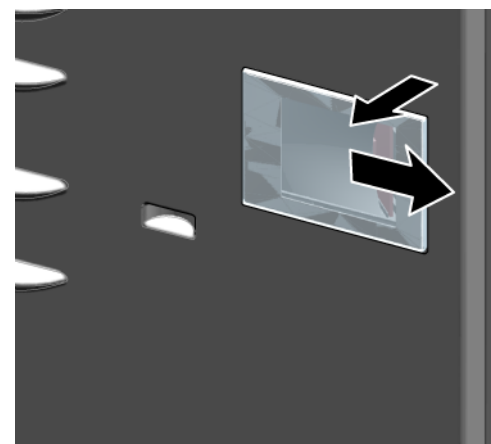

3. Odklopite modul točkovne lučke LED.

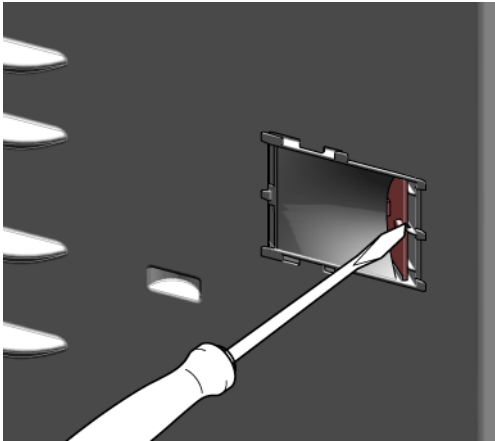

4. Odklopite električno povezavo točkovne lučke LED.

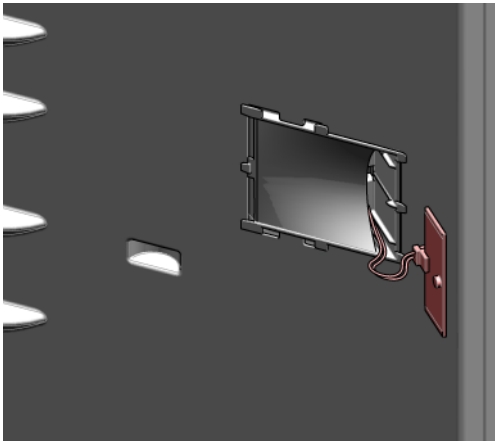





-  Točkovna lučka LED je odstranjena.

4.17.2 Namestitev točkovne lučke LED

- ▶ Namestite v obratnem vrstnem redu.

Consejos de reparación - Frigorífico / congelador

 En relación con este documento	612
1.1 Información importante	612
1.1.1 Finalidad	612
1.2 Explicación de símbolos generales	612
1.2.1 Niveles de peligrosidad	612
1.2.2 Símbolos de peligro	612
1.2.3 Estructura de las advertencias	613
1.2.4 Símbolos generales	613
 Seguridad	614
2.1 Instrucciones generales de seguridad	614
2.1.1 Todos los aparatos electrodomésticos.....	614
 Herramientas y auxiliares	615
 Reparación	616
4.1 Sustituir la junta de la puerta	616
4.1.1 Retirar la junta de la puerta.....	616
4.1.2 Montar la junta de la puerta	616
4.2 Sustituir el tirador de la puerta.....	619
4.2.1 Retirar el tirador de la puerta	619
4.2.2 Montar el tirador de la puerta	619
4.3 Sustituir la bisagra superior de la puerta	620
4.3.1 Desmontar la bisagra superior de la puerta.....	620
4.3.2 Montar la bisagra superior de la puerta	621
4.4 Sustituir la bisagra superior de la puerta (puerta con display).....	622
4.4.1 Desmontar la bisagra superior de la puerta.....	622
4.4.2 Montar la bisagra superior de la puerta	623
4.5 Sustituir la bisagra central de la puerta	624
4.5.1 Desmontar la bisagra central de la puerta.....	624
4.5.2 Montar la bisagra central de la puerta.....	624
4.6 Sustituir la bisagra inferior de la puerta	625
4.6.1 Desmontar la bisagra inferior de la puerta	625
4.6.2 Montar la bisagra inferior de la puerta	625
4.7 Sustituir el estante	626
4.7.1 Extraer el estante.....	626
4.7.2 Montar el estante	626

4.8 Sustituir la bandeja botellero.....	627
4.8.1 Extraer la bandeja botellero.....	627
4.8.2 Montar la bandeja botellero	627
4.9 Sustituir el estante de la puerta	628
4.9.1 Extraer el estante de la puerta.....	628
4.9.2 Montar el estante de la puerta	628
4.10 Sustituir el estante ajustable de la puerta	629
4.10.1 Extraer el estante ajustable de la puerta	629
4.10.2 Montar el estante ajustable de la puerta.....	629
4.11 Sustituir el cajón de productos congelados	630
4.11.1 Extraer el cajón de productos congelados.....	630
4.11.2 Montar el cajón de productos congelados	630
4.12 Sustituir el cajón	631
4.12.1 Extraer el cajón	631
4.12.2 Montar el cajón.....	631
4.13 Sustituir el cajón extraíble.....	632
4.13.1 Retirar el cajón extraíble	632
4.13.2 Montar el cajón extraíble	632
4.14 Sustituir el foco LED.....	633
4.14.1 Desmontar el foco LED	633
4.14.2 Montar el foco LED	633
4.15 Sustituir la iluminación LED superior	634
4.15.1 Desmontar la iluminación LED	634
4.15.2 Montar la iluminación LED superior	635
4.16 Sustituir la barra de luz LED lateral	636
4.16.1 Retirar la barra de luz LED lateral.....	636
4.16.2 Montar la barra de luz LED lateral	637
4.17 Sustituir el foco LED.....	638
4.17.1 Desmontar el foco LED	638
4.17.2 Montar el foco LED	639

i En relación con este documento

1.1 Información importante

1.1.1 Finalidad

Estas indicaciones de reparación sirven como ayuda al consumidor para reparar aparatos por su cuenta conforme al reglamento aplicable sobre diseño ecológico (a partir de 03/2021).

Contienen información sobre cómo sustituir repuestos determinados e incluye las advertencias y los riesgos.

En caso de dudas, póngase en contacto con nuestro departamento de atención al cliente. Solo asumiremos la responsabilidad por daños si las indicaciones de reparación se han seguido correctamente.

1.2 Explicación de símbolos generales

1.2.1 Niveles de peligrosidad

Los niveles de peligro consisten en un símbolo y una palabra de advertencia. La palabra de advertencia identifica la gravedad del peligro.





Nivel de peligro	Significado
 PELIGRO	Si no se tiene en cuenta la advertencia, ocasionará la muerte o lesiones graves.
 ADVERTENCIA	Si no se tiene en cuenta la advertencia, puede ocasionar la muerte o lesiones graves.
 PRECAUCIÓN	Si no se tiene en cuenta la advertencia, puede ocasionar lesiones de carácter leve.
ATENCIÓN	Si no se tiene en cuenta la advertencia, puede ocasionar daños materiales.

Tabla 1: Niveles de peligrosidad

1.2.2 Símbolos de peligro

Los símbolos de peligro son una representación simbólica que indica el tipo de peligrosidad.

En este documento se utilizan los siguientes símbolos de peligro:

Símbolo de peligro	Significado
	Advertencia general
	Peligro de lesiones por corriente eléctrica
	Riesgo de explosión
	Peligro de lesiones a causa de cortes

i En relación con este documento





Símbolo de peligro	Significado
	Peligro de lesiones por aplastamiento
	Peligro de lesiones por superficies calientes
	Peligro a causa de campos magnéticos de gran potencia
	Peligro derivado de radiación no ionizante

Tabla 2: Símbolos de peligro

1.2.3 Estructura de las advertencias

Las advertencias de este documento tienen una apariencia y una estructura uniformes.

	<p>⚠ PELIGRO</p> <p>¡Tipo y fuente del peligro! Posibles consecuencias de ignorar el peligro / la advertencia.</p> <ul style="list-style-type: none"> ▶ Medidas y prohibiciones para prevenir el peligro.
--	--

El ejemplo siguiente muestra una advertencia de descarga eléctrica a causa de piezas o partes cargadas con tensión. Se menciona la medida para evitar el peligro.

	<p>⚠ PELIGRO</p> <p>¡Riesgo de descarga eléctrica debido a partes con tensión! Muerte por electrocución</p> <ul style="list-style-type: none"> ▶ Desconectar el aparato de la red al menos 60 segundos antes de comenzar con la reparación.
--	--

1.2.4 Símbolos generales

En este documento se utilizan los siguientes símbolos generales:

Símbolo general	Significado
	Identificación de una indicación especial (texto y/o gráfico)







Símbolo general	Significado
	Identificación de un consejo simple (solo texto)
	Identificación de un enlace a un video tutorial
	Identificación de una herramienta requerida
	Identificación de una condición previa (prerrequisito)
	Identificación de una condición (si ..., entonces ...)
	Identificación de un resultado
Iniciar	Identificación de una tecla o botón
[00123456]	Identificación de un número de material
Estado	Identificación del texto / ventana mostrado (en el display del aparato)

Tabla 3: Símbolos generales

2.1 Instrucciones generales de seguridad

2.1.1 Todos los aparatos electrodomésticos

¡Riesgo de descarga eléctrica debido a piezas con tensión!

- ¡Los errores en las reparaciones que incluyan componentes eléctricos pueden provocar una descarga eléctrica!
- Desconectar el aparato de la red durante al menos 60 segundos antes de comenzar con el trabajo.
- Después de la reparación, encargar una prueba de seguridad conforme a VDE 0701 o los reglamentos específicos del país.

¡Riesgo de lesiones debido a bordes afilados!

- Usar guantes de protección.

Riesgo de aplastamiento durante la reparación, mantenimiento, resolución de problemas y servicio debido a componentes pesados y móviles

- Usar calzado de seguridad.
- Asegure los componentes pesados para que no se caigan.
- No pegue partes del cuerpo en componentes móviles.





¡Riesgo para la seguridad/el funcionamiento del aparato!

- Utilizar únicamente los repuestos originales.

¡Riesgo de daños de los componentes sensibles a cargas electrostáticas (ESD)!

- No tocar los módulos, incluidas las conexiones y las pistas conductoras.

Herramientas y auxiliares

Designación	Detalles	Imágenes
Paño de protección [00342013]	60 cm x 50 cm	
Destornillador plano	Punta 2,4 mm x 0,4 mm x 60 mm, en el kit [00341820]	
Herramienta especial [00342180]		
Ventosa [00342224]	Ø50 mm	
Punta Torx TX20 [00340865]	6,3 mm (1/4")	
Destornillador plano	Punta 10 mm x 1,6 mm x 200 mm	

4.1 Sustituir la junta de la puerta

Requisito:

- ✔ La puerta está abierta.

4.1.1 Retirar la junta de la puerta

1. Soltar la junta de la puerta de la ranura por las esquinas izquierda y derecha.

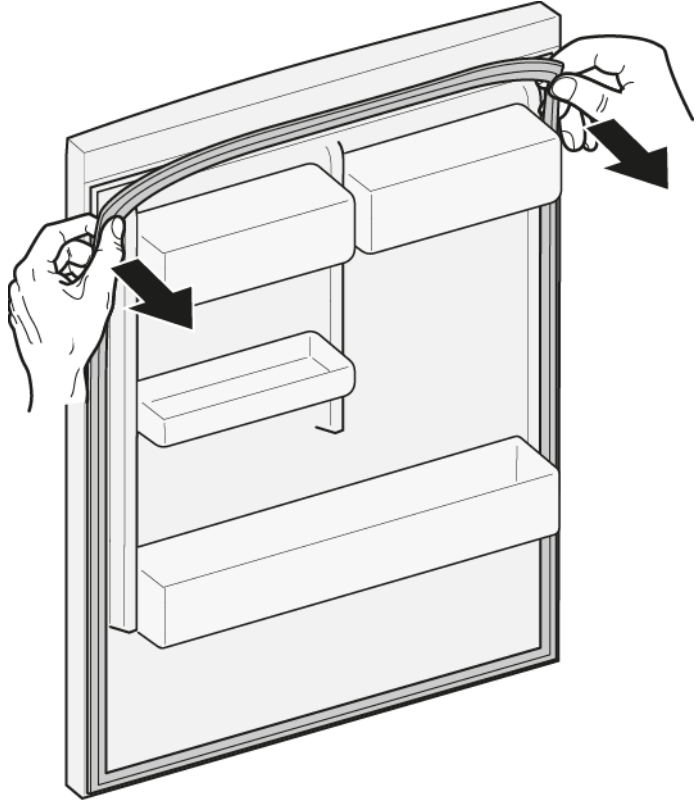

2. Sacar la junta de la puerta de la ranura.

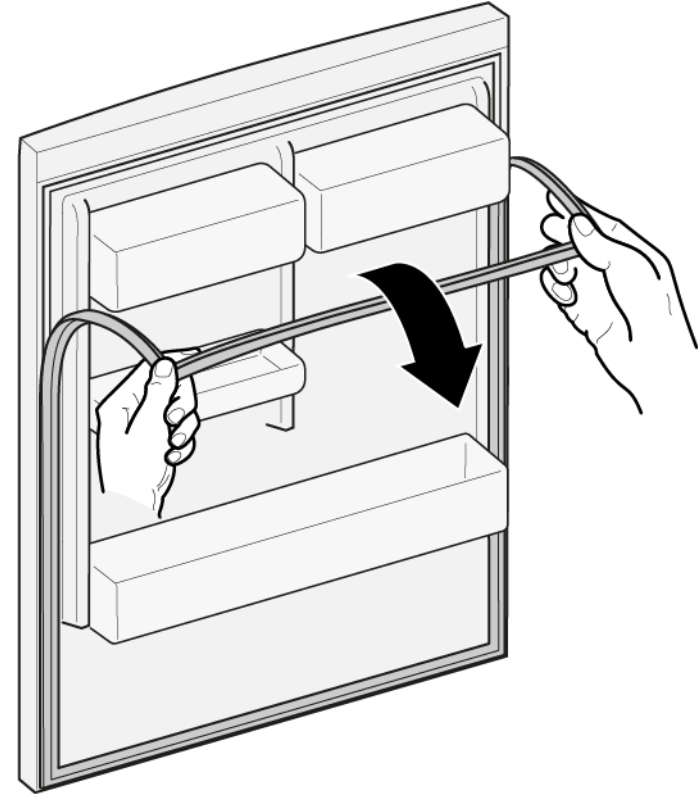

- ➡ Se ha retirado la junta de la puerta.

4.1.2 Montar la junta de la puerta

	El grosor de la nueva junta de la puerta puede diferir ligeramente del grosor de la junta usada. Esto no afectará al comportamiento de cierre ni al funcionamiento a largo plazo.
	Si su aparato tienen bisagras ajustables o accesorios de bisagra, puede optimizar el comportamiento de cierre.
	Los pequeños agujeros laterales de la junta de la puerta son funcionales (necesarios para la ventilación). No se trata de un fallo de producción.

Reparación

1. Comprobar si la ranura de la junta presenta daños.

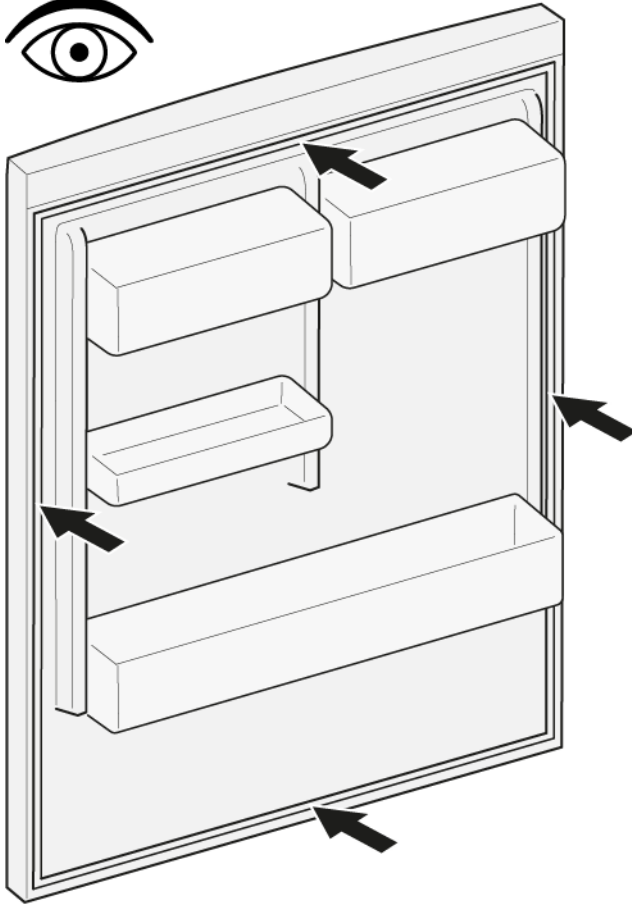

4. Presionar las esquinas de la junta en la parte superior y la inferior de la ranura.

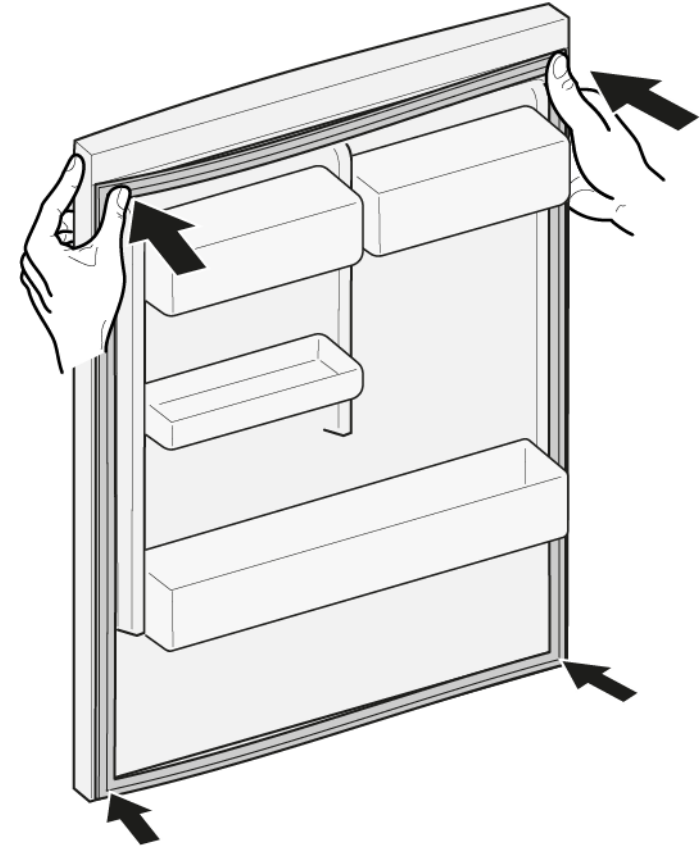

2.  Si la ranura de la junta está dañada.
 - Contactar con el servicio de atención al cliente.

3.

	Una ligera deformación de la junta de la puerta es normal y no afecta a su función. Se recomienda alisar la junta de la puerta antes de insertarla en el aparato.
---	---

Calentar ligeramente la junta de la puerta con un secador de pelo o agua caliente y volver a darle forma con las manos.

Reparación

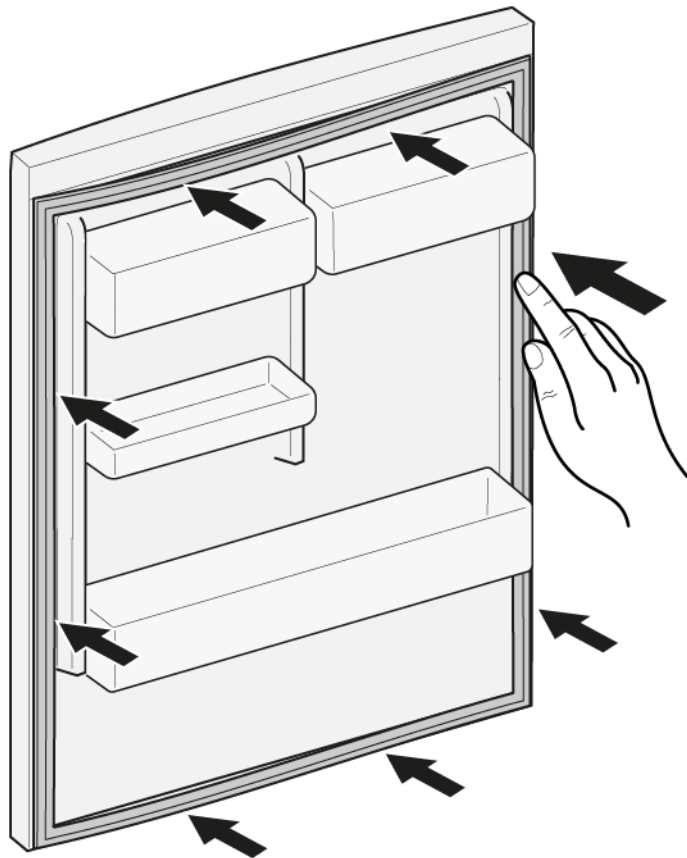

5. Presionar metiendo toda la junta paso a paso en la ranura.





-  La junta de la puerta está montada.

4.2 Sustituir el tirador de la puerta

Herramientas necesarias:

-  Punta Torx TX20 6,3 mm (1/4") [00340865]
-  Destornillador plano Punta 10 mm x 1,6 mm x 200 mm

Requisito:

-  El aparato está desconectado del suministro eléctrico.
-  La puerta está abierta.

4.2.1 Retirar el tirador de la puerta

- ▶ 1. Retirar las tapas de los dos tornillos (1).
- ▶ 2. Desatornillar los dos tornillos (2).
- ▶ 3. Retirar el tirador de la puerta (3).

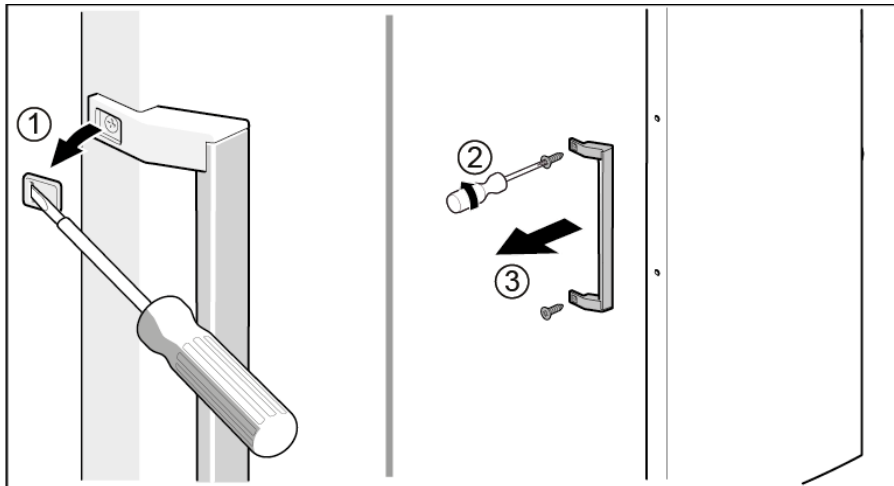

 Se ha retirado el tirador de la puerta.



El tirador de la segunda puerta puede retirarse del mismo modo.

4.2.2 Montar el tirador de la puerta

- ▶ Montar en orden inverso.

4.3 Sustituir la bisagra superior de la puerta

Herramientas necesarias:

🔧 Punta Torx TX20 6,3 mm (1/4") [00340865]

	⚠️ ADVERTENCIA
<p>¡Aparatos pesados y voluminosos! Espalda y lesiones musculares</p> <ul style="list-style-type: none"> ▶ La operación de extraer la puerta del aparato solo deben llevarla a cabo especialistas formados. ▶ Para mover el aparato se necesitan dos personas. ▶ Utilizar únicamente herramientas y equipos apropiados. 	

	⚠️ PRECAUCIÓN
<p>¡Bordes o cantos cortantes! Peligro de cortes</p> <ul style="list-style-type: none"> ▶ Usar guantes de seguridad. 	

	⚠️ ADVERTENCIA
<p>¡Deslizamiento de aparatos inclinados! Fracturas óseas / lesiones por aplastamiento</p> <ul style="list-style-type: none"> ▶ Asegurar los electrodomésticos contra deslizamientos. 	

	⚠️ PRECAUCIÓN
<p>¡Riesgo de que se caigan piezas debido a los tornillos aflojados! Peligro de lesiones debido a piezas que caigan.</p> <ul style="list-style-type: none"> ▶ Asegure el componente para que no se caiga. 	

	ATENCIÓN
<p>¡Riesgo de que se caigan piezas debido a los tornillos aflojados! Daños en otras partes del aparato o en el domicilio del consumidor, p. ej., en la parte inferior.</p> <ul style="list-style-type: none"> ▶ Asegure el componente para que no se caiga. 	

Requisito:

- ✔ El aparato está desconectado del suministro eléctrico.
- ✔ Se han retirado los accesorios del interior del aparato.

4.3.1 Desmontar la bisagra superior de la puerta

1. Colocar el aparato sobre su lado posterior.

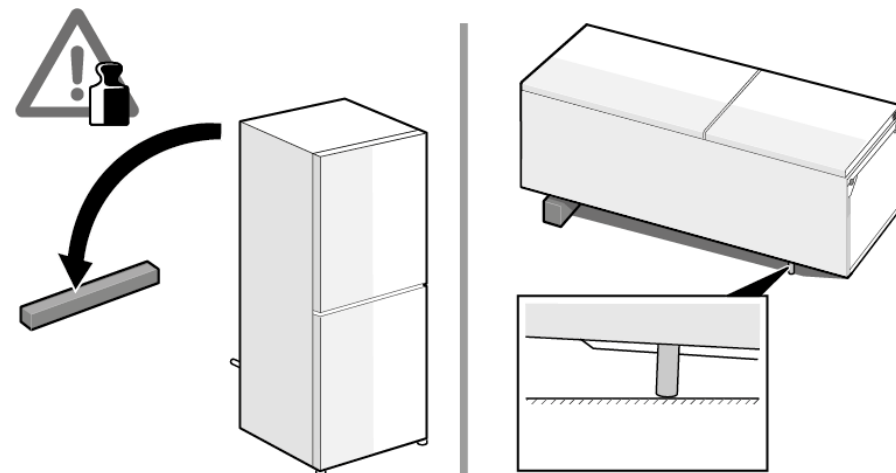

Reparación

2. 1. Presionar la tapa de la bisagra superior en ambos lados (1).
2. Sacar la tapa de la bisagra superior (2).
3. Girar la tapa de la bisagra (3).
4. Retirar la tapa de la bisagra superior (4).
5. Desatornillar los dos tornillos (5).
6. Retirar la bisagra superior (6).

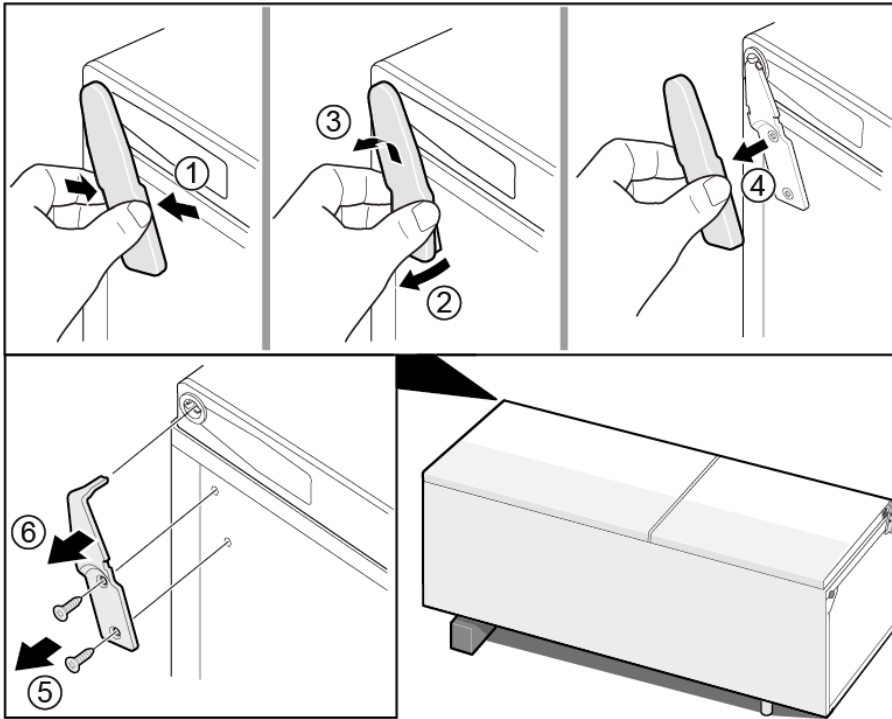

 Se ha retirado la bisagra superior.

4.3.2 Montar la bisagra superior de la puerta

- ▶ Montar en orden inverso.

4.4 Sustituir la bisagra superior de la puerta (puerta con display)

Herramientas necesarias:

 Punta Torx TX20 6,3 mm (1/4") [00340865]

	⚠ ADVERTENCIA
	<p>¡Aparatos pesados y voluminosos! Espalda y lesiones musculares</p> <ul style="list-style-type: none"> ▶ La operación de extraer la puerta del aparato solo deben llevarla a cabo especialistas formados. ▶ Para mover el aparato se necesitan dos personas. ▶ Utilizar únicamente herramientas y equipos apropiados.

	⚠ PRECAUCIÓN
	<p>¡Bordes o cantos cortantes! Peligro de cortes</p> <ul style="list-style-type: none"> ▶ Usar guantes de seguridad.

	⚠ ADVERTENCIA
	<p>¡Deslizamiento de aparatos inclinados! Fracturas óseas / lesiones por aplastamiento</p> <ul style="list-style-type: none"> ▶ Asegurar los electrodomésticos contra deslizamientos.



	⚠ PRECAUCIÓN
	<p>¡Riesgo de que se caigan piezas debido a los tornillos aflojados! Peligro de lesiones debido a piezas que caigan.</p> <ul style="list-style-type: none"> ▶ Asegure el componente para que no se caiga.

	ATENCIÓN
	<p>¡Riesgo de que se caigan piezas debido a los tornillos aflojados! Daños en otras partes del aparato o en el domicilio del consumidor, p. ej., en la parte inferior.</p> <ul style="list-style-type: none"> ▶ Asegure el componente para que no se caiga.

	⚠ PELIGRO
	<p>¡Riesgo de descarga eléctrica debido a piezas con tensión! Peligro mortal por descarga eléctrica en caso de reparación inadecuada</p> <ul style="list-style-type: none"> ▶ Las piezas eléctricas deberían ser reparadas por electricistas cualificados. ▶ Después de la reparación, encargar una prueba de seguridad conforme a VDE 0701 o los reglamentos específicos del país.

	⚠ PELIGRO
	<p>¡Riesgo de descarga eléctrica debido a partes con tensión! Muerte por electrocución</p> <ul style="list-style-type: none"> ▶ Desconectar el aparato de la red al menos 60 segundos antes de comenzar con la reparación.

Requisito:

-  El aparato está desconectado del suministro eléctrico.
-  Se han retirado los accesorios del interior del aparato.

4.4.1 Desmontar la bisagra superior de la puerta

- Colocar el aparato sobre su lado posterior.

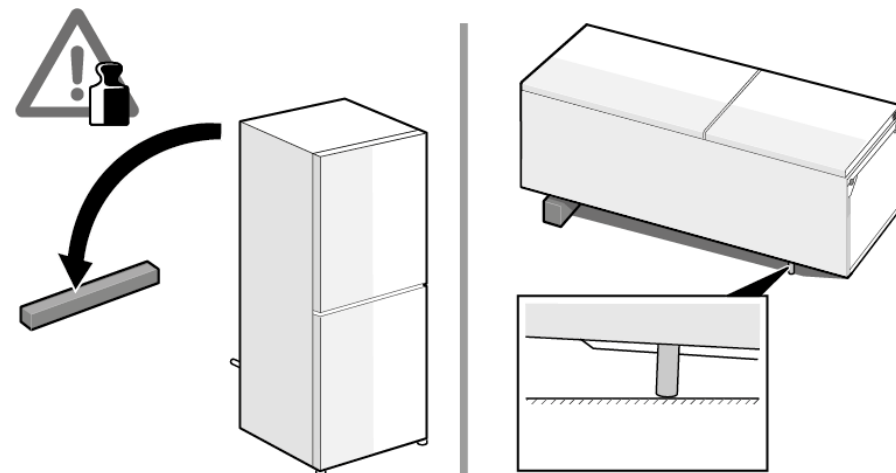

Reparación

2. 1. Retirar la tapa de la bisagra superior (1).
2. Retirar la tapa de la caja de cables (2).
3. Desconectar la conexión eléctrica (3).
4. Desatornillar el tornillo de la conexión a tierra (4).
5. Retirar la protección de cables (5).
6. Desatornillar el tornillo (6)

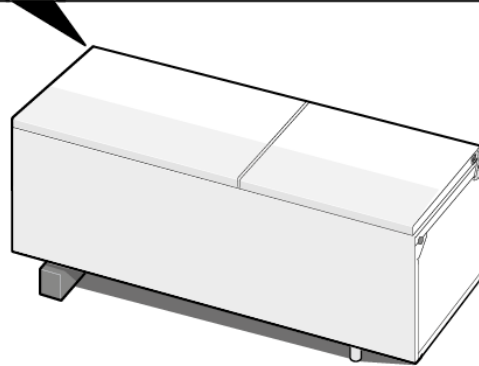
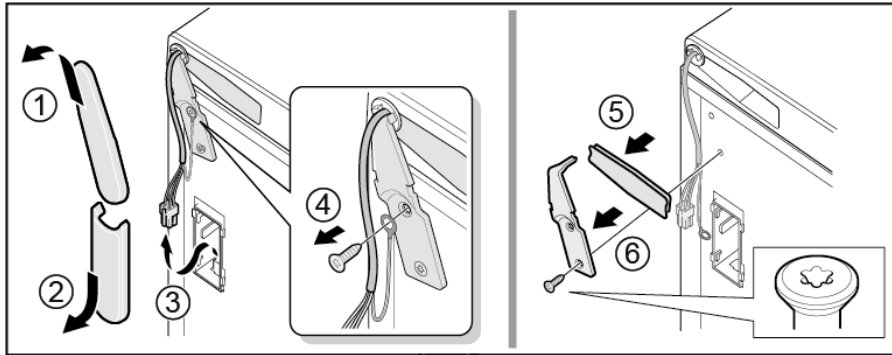

 Se ha retirado la bisagra superior.

4.4.2 Montar la bisagra superior de la puerta

- ▶ Montar en orden inverso.

4.5 Sustituir la bisagra central de la puerta

Herramientas necesarias:

🔧 Punta Torx TX20 6,3 mm (1/4") [00340865]

	⚠️ ADVERTENCIA
	<p>¡Aparatos pesados y voluminosos! Espalda y lesiones musculares</p> <ul style="list-style-type: none"> ▶ La operación de extraer la puerta del aparato solo deben llevarla a cabo especialistas formados. ▶ Para mover el aparato se necesitan dos personas. ▶ Utilizar únicamente herramientas y equipos apropiados.

	⚠️ PRECAUCIÓN
	<p>¡Bordes o cantos cortantes! Peligro de cortes</p> <ul style="list-style-type: none"> ▶ Usar guantes de seguridad.

	⚠️ ADVERTENCIA
	<p>¡Deslizamiento de aparatos inclinados! Fracturas óseas / lesiones por aplastamiento</p> <ul style="list-style-type: none"> ▶ Asegurar los electrodomésticos contra deslizamientos.

	⚠️ PRECAUCIÓN
	<p>¡Riesgo de que se caigan piezas debido a los tornillos aflojados! Peligro de lesiones debido a piezas que caigan.</p> <ul style="list-style-type: none"> ▶ Asegure el componente para que no se caiga.

	⚠️ ATENCION
	<p>¡Riesgo de que se caigan piezas debido a los tornillos aflojados! Daños en otras partes del aparato o en el domicilio del consumidor, p. ej., en la parte inferior.</p> <ul style="list-style-type: none"> ▶ Asegure el componente para que no se caiga.

Requisito:

- ✔ El aparato está desconectado del suministro eléctrico.
- ✔ Se han retirado los accesorios del interior del aparato.
- ✔ Se ha retirado la bisagra superior de la puerta.

4.5.1 Desmontar la bisagra central de la puerta

- ▶ 1. Extraer la puerta del refrigerador (1).
- ▶ 2. Desatornillar los dos tornillos (2).
- ▶ 3. Retirar la bisagra central (3).

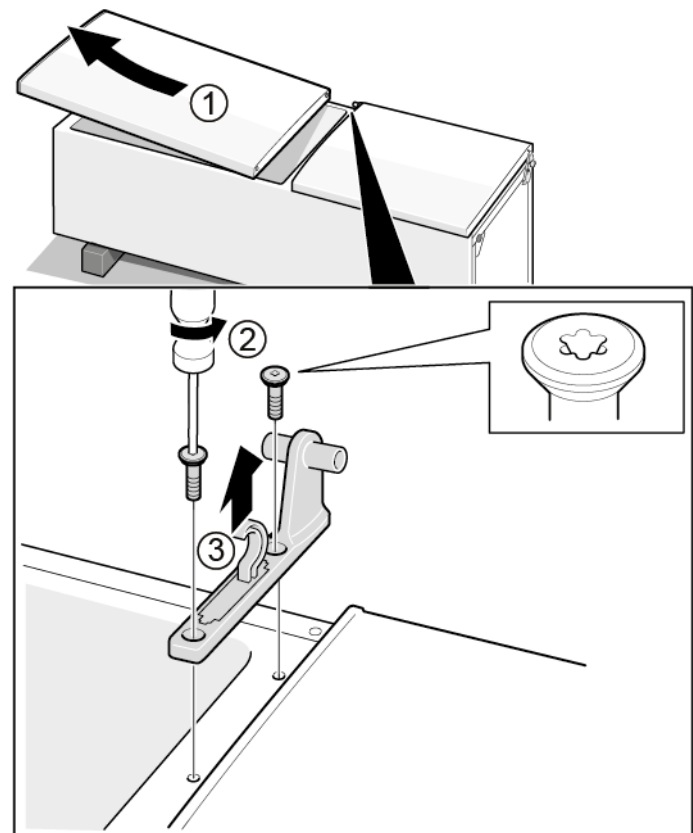

➡ Se ha retirado la bisagra central.

4.5.2 Montar la bisagra central de la puerta

- ▶ Montar en orden inverso.

4.6 Sustituir la bisagra inferior de la puerta

Herramientas necesarias:

🔧 Punta Torx TX20 6,3 mm (1/4") [00340865]

	⚠️ ADVERTENCIA
	<p>¡Aparatos pesados y voluminosos! Espalda y lesiones musculares</p> <ul style="list-style-type: none"> ▶ La operación de extraer la puerta del aparato solo deben llevarla a cabo especialistas formados. ▶ Para mover el aparato se necesitan dos personas. ▶ Utilizar únicamente herramientas y equipos apropiados.

	⚠️ PRECAUCIÓN
	<p>¡Bordes o cantos cortantes! Peligro de cortes</p> <ul style="list-style-type: none"> ▶ Usar guantes de seguridad.

	⚠️ ADVERTENCIA
	<p>¡Deslizamiento de aparatos inclinados! Fracturas óseas / lesiones por aplastamiento</p> <ul style="list-style-type: none"> ▶ Asegurar los electrodomésticos contra deslizamientos.

	⚠️ PRECAUCIÓN
	<p>¡Riesgo de que se caigan piezas debido a los tornillos aflojados! Peligro de lesiones debido a piezas que caigan.</p> <ul style="list-style-type: none"> ▶ Asegure el componente para que no se caiga.

	⚠️ ATENCION
	<p>¡Riesgo de que se caigan piezas debido a los tornillos aflojados! Daños en otras partes del aparato o en el domicilio del consumidor, p. ej., en la parte inferior.</p> <ul style="list-style-type: none"> ▶ Asegure el componente para que no se caiga.

Requisito:

- ✔ El aparato está desconectado del suministro eléctrico.
- ✔ Se han retirado los accesorios del interior del aparato.
- ✔ Se ha retirado la bisagra superior.

✔ Se ha retirado la bisagra central.

4.6.1 Desmontar la bisagra inferior de la puerta

- ▶ 1. Extraer la puerta del congelador (1).
- ▶ 2. Desatornillar el tornillo (2).
- ▶ 3. Girar la bisagra inferior hacia fuera (3).
- ▶ 4. Retirar la bisagra inferior (4).

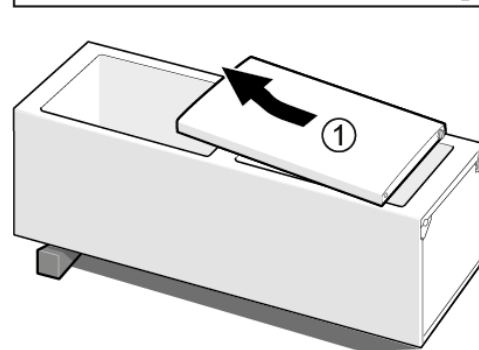
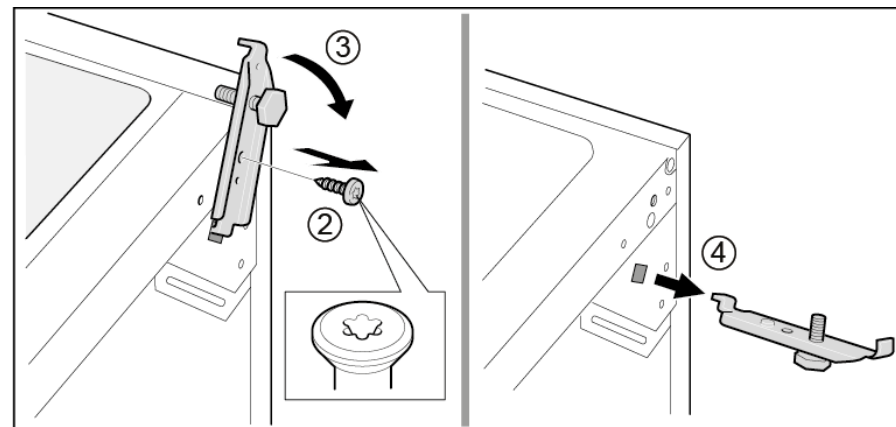

➡ Se ha retirado la bisagra inferior de la puerta.

4.6.2 Montar la bisagra inferior de la puerta

- ▶ Montar en orden inverso.

4.7 Sustituir el estante

Requisito:

- ✔ La puerta está abierta.

4.7.1 Extraer el estante

- ▶ Sacar el estante.

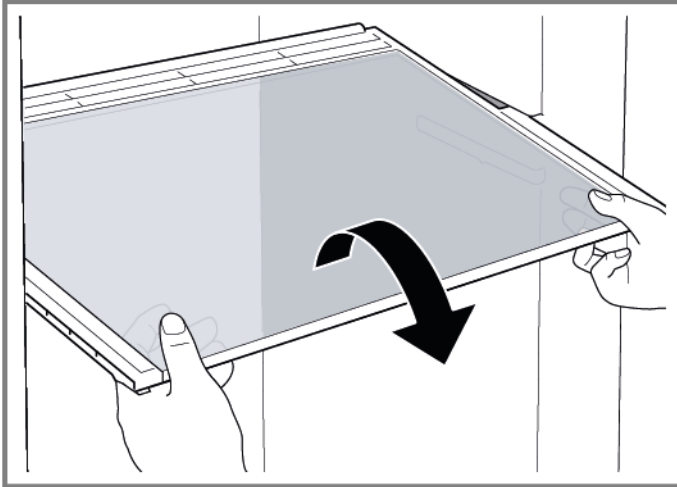

- ➡ Se ha retirado el estante.

4.7.2 Montar el estante

- ▶ Montar en orden inverso.

4.8 Sustituir la bandeja botellero

Requisito:

- ✔ La puerta está abierta.

4.8.1 Extraer la bandeja botellero

- ▶ Sacar la bandeja botellero.

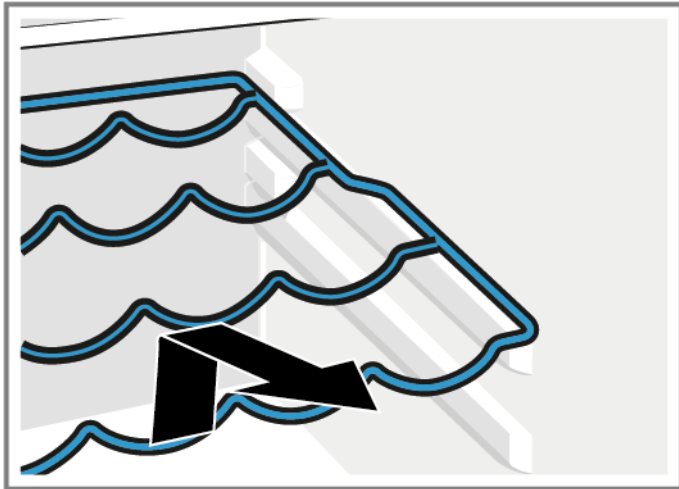

- ➡ Se ha retirado la bandeja botellero.

4.8.2 Montar la bandeja botellero

- ▶ Montar en orden inverso.

4.9 Sustituir el estante de la puerta

Requisito:

- ✔ La puerta está abierta.

4.9.1 Extraer el estante de la puerta

- ▶ Sacar hacia arriba el estante de la puerta.

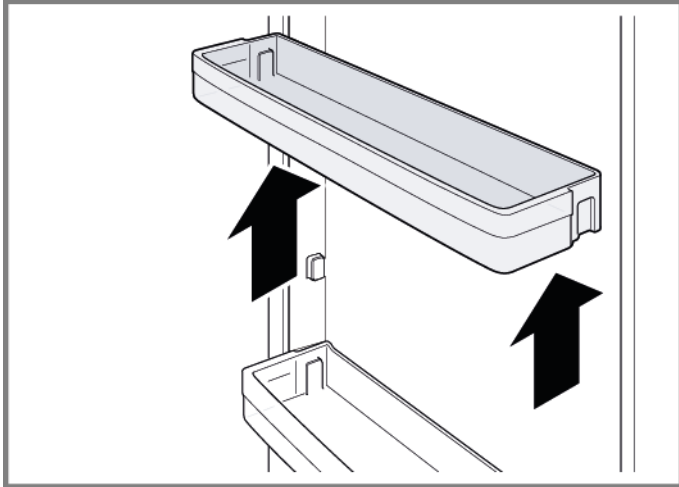

- ➡ Se ha retirado el estante de la puerta.

4.9.2 Montar el estante de la puerta

- ▶ Montar en orden inverso.

4.10 Sustituir el estante ajustable de la puerta

Requisito:

- ✔ La puerta está abierta.

4.10.1 Extraer el estante ajustable de la puerta

- ▶ Desplazar el estante ajustable superior de la puerta hacia arriba hasta que se suelte del soporte.

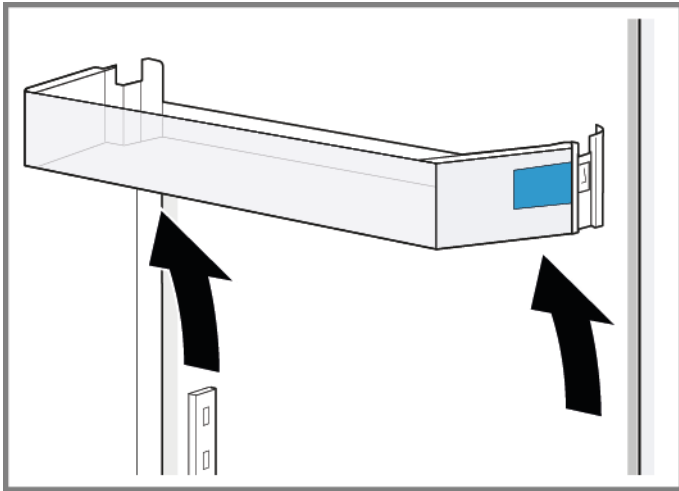

- ➡ Se ha retirado el estante ajustable de la puerta.

4.10.2 Montar el estante ajustable de la puerta

- ▶ Montar en orden inverso.

4.11 Sustituir el cajón de productos congelados

Requisito:

- ✔ La puerta está abierta.

4.11.1 Extraer el cajón de productos congelados

- ▶ 1. Sacar por completo el cajón de productos congelados (1).
- ▶ 2. Extraer el cajón para alimentos (2).

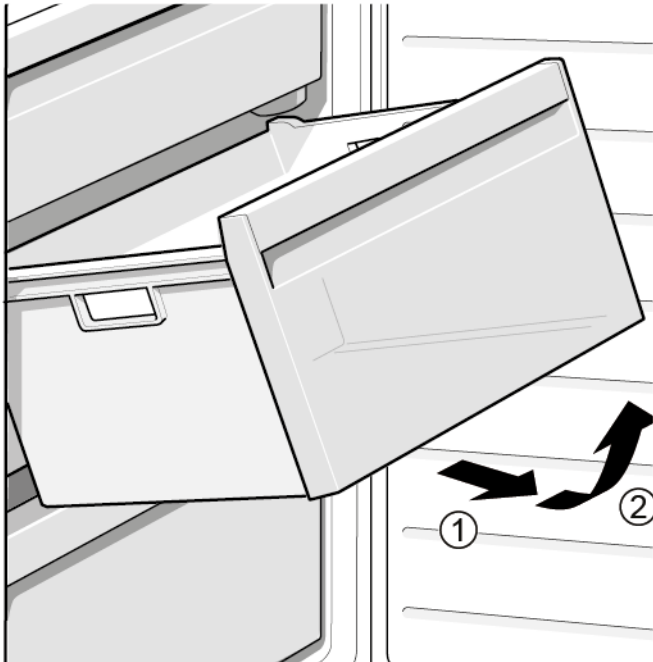

- ➡ Se ha retirado el cajón de productos congelados.

4.11.2 Montar el cajón de productos congelados

- ▶ Montar en orden inverso.

4.12 Sustituir el cajón

Requisito:

- ✔ La puerta está abierta.

4.12.1 Extraer el cajón

- ▶ 1. Sacar el cajón inferior del frigorífico (1).
- ▶ 2. Sacar el cajón superior del frigorífico (2).

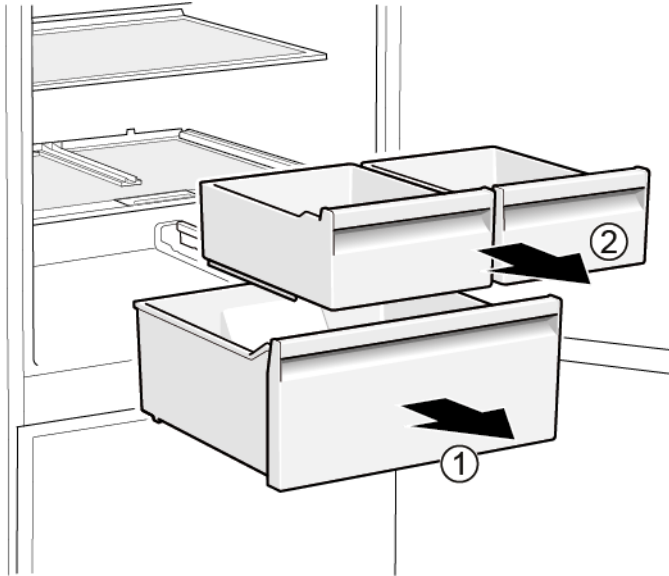

- ➡ Se han extraído los cajones.

4.12.2 Montar el cajón

- ▶ Montar en orden inverso.

4.13 Sustituir el cajón extraíble

Requisito:

- ✔ La puerta está abierta.

4.13.1 Retirar el cajón extraíble

- ▶ 1. Sacar por completo el cajón extraíble (1).
- ▶ 2. Retirar el cajón extraíble (2).

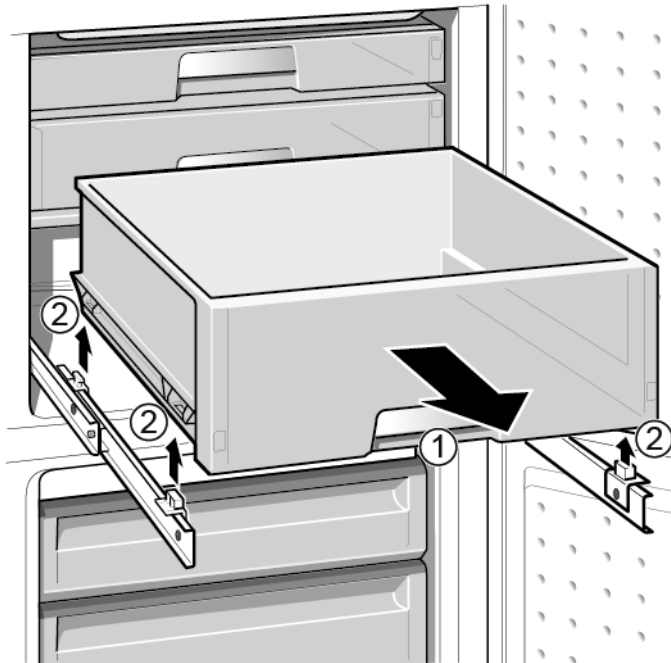

- ➡ Se ha retirado el cajón extraíble.

4.13.2 Montar el cajón extraíble

- ▶ Montar en orden inverso.

4.14 Sustituir el foco LED

Herramientas necesarias:

Herramienta especial [00342180]



Su aparato cuenta con una iluminación LED exenta de mantenimiento.
¡Solo el servicio de atención al cliente o los técnicos autorizados pueden reparar esta iluminación!



PELIGRO

¡Riesgo de descarga eléctrica debido a piezas con tensión!

Peligro mortal por descarga eléctrica en caso de reparación inadecuada

- ▶ Las piezas eléctricas deberían ser reparadas por electricistas cualificados.
- ▶ Después de la reparación, encargar una prueba de seguridad conforme a VDE 0701 o los reglamentos específicos del país.



PELIGRO

¡Riesgo de descarga eléctrica debido a partes con tensión!

Muerte por electrocución

- ▶ Desconectar el aparato de la red al menos 60 segundos antes de comenzar con la reparación.



PRECAUCIÓN

¡Bordes o cantos cortantes!

Peligro de cortes

- ▶ Usar guantes de seguridad.

Requisito:

- ✓ El aparato está desconectado del suministro eléctrico.
- ✓ La puerta está abierta.

4.14.1 Desmontar el foco LED

1. Utilizar una herramienta especial para sacar el foco LED (1).

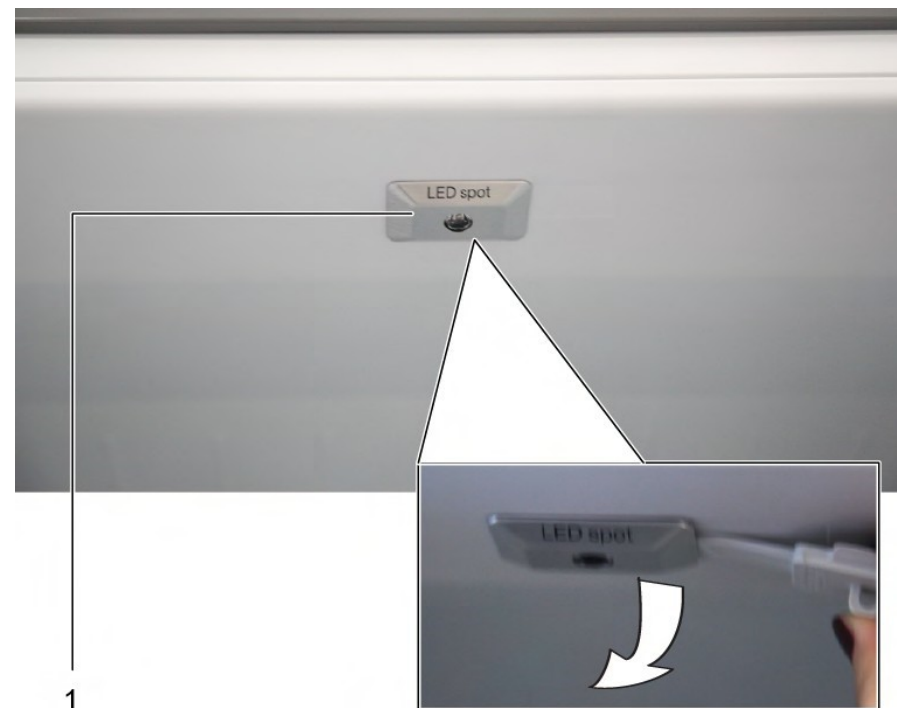

2. Desconectar las conexiones eléctricas del foco LED.

➡ Se ha retirado el foco LED.

4.14.2 Montar el foco LED

- ▶ Montar en orden inverso.

4.15 Sustituir la iluminación LED superior

Herramientas necesarias:

- Destornillador plano Punta 2,4 mm x 0,4 mm x 60 mm, en el kit [00341820]



Su aparato cuenta con una iluminación LED exenta de mantenimiento. ¡Solo el servicio de atención al cliente o los técnicos autorizados pueden reparar esta iluminación!



PELIGRO

¡Riesgo de descarga eléctrica debido a piezas con tensión!

Peligro mortal por descarga eléctrica en caso de reparación inadecuada

- Las piezas eléctricas deberían ser reparadas por electricistas cualificados.
- Después de la reparación, encargar una prueba de seguridad conforme a VDE 0701 o los reglamentos específicos del país.



PELIGRO

¡Riesgo de descarga eléctrica debido a partes con tensión!

Muerte por electrocución

- Desconectar el aparato de la red al menos 60 segundos antes de comenzar con la reparación.



PRECAUCIÓN

¡Bordes o cantos cortantes!

Peligro de cortes

- Usar guantes de seguridad.

Requisito:

- El aparato está desconectado del suministro eléctrico.
- La puerta está abierta.
- Se han retirado los accesorios superiores del interior.

4.15.1 Desmontar la iluminación LED

- Mover la iluminación LED hacia el lado izquierdo.

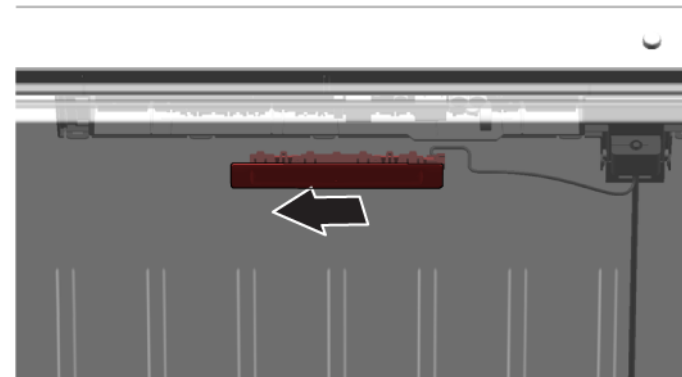

- Se ha desconectado la conexión eléctrica de la iluminación LED.

- Soltar los ganchos de la iluminación LED.

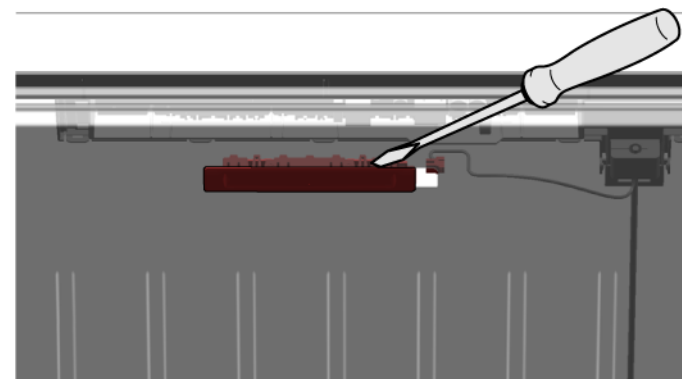

Reparación

3. Retirar la iluminación LED moviéndola hacia delante.

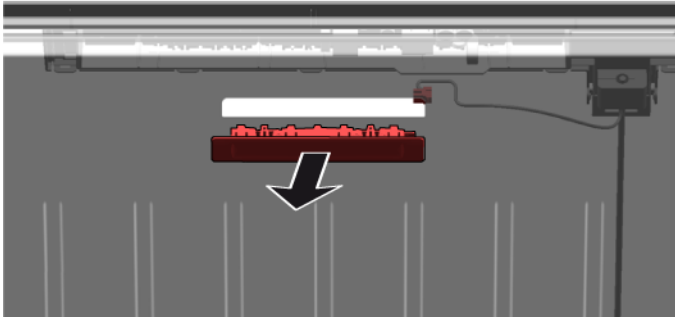

- ➡ Se ha retirado la iluminación LED.

4.15.2 Montar la iluminación LED superior

- ▶ Montar en orden inverso.

4.16 Sustituir la barra de luz LED lateral

Herramientas necesarias:

 Ventosa Ø50 mm [00342224]



 Su aparato cuenta con una iluminación LED exenta de mantenimiento.
¡Solo el servicio de atención al cliente o los técnicos autorizados pueden reparar esta iluminación!

 **PELIGRO**
¡Riesgo de descarga eléctrica debido a piezas con tensión!
Peligro mortal por descarga eléctrica en caso de reparación inadecuada.
▶ Las piezas eléctricas deberían ser reparadas por electricistas cualificados.
▶ Después de la reparación, encargar una prueba de seguridad conforme a VDE 0701 o los reglamentos específicos del país.

 **PELIGRO**
¡Riesgo de descarga eléctrica debido a partes con tensión!
Muerte por electrocución
▶ Desconectar el aparato de la red al menos 60 segundos antes de comenzar con la reparación.

 **PRECAUCIÓN**
¡Bordes o cantos cortantes!
Peligro de cortes
▶ Usar guantes de seguridad.

Requisito:

-  El aparato está desconectado del suministro eléctrico.
-  La puerta está abierta.
-  Se han retirado los estantes del refrigerador.

4.16.1 Retirar la barra de luz LED lateral

1. Colocar la ventosa en el tercio superior de la barra de luz LED lateral.



Reparación

2. Con un movimiento de rotación, tirar de la ventosa enganchada a la parte delantera de la barra de luz LED lateral.

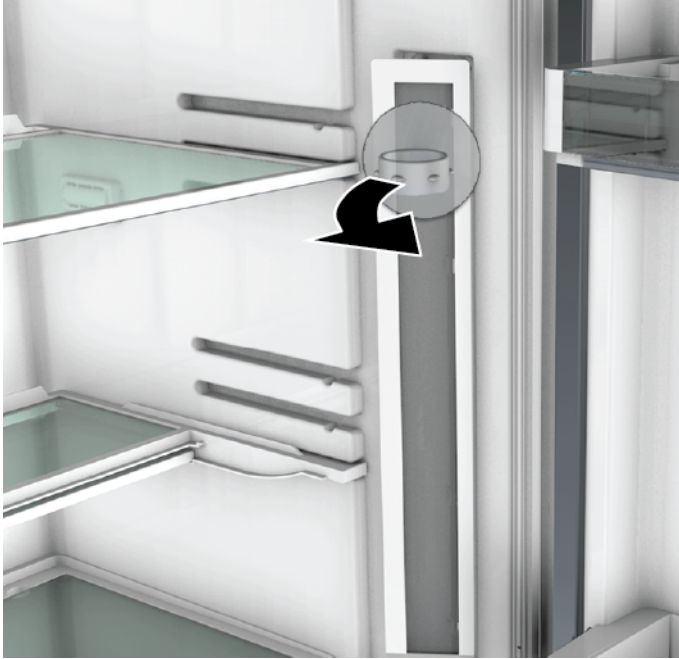

3. Desconectar la conexión eléctrica de la barra de luz LED lateral.
 Se ha retirado la barra de luz LED lateral.

4.16.2 Montar la barra de luz LED lateral

1. Conectar la conexión eléctrica de la barra de luz LED lateral.
 2. Fijar la barra de luz LED lateral en su ubicación en la pared del cajón (los ganchos deben hacer clic).
-  Se ha montado la barra de luz LED lateral.

4.17 Sustituir el foco LED

Herramientas necesarias:

- Herramienta especial [00342180]
- Destornillador plano Punta 2,4 mm x 0,4 mm x 60 mm, en el kit [00341820]



Su aparato cuenta con una iluminación LED exenta de mantenimiento.
¡Solo el servicio de atención al cliente o los técnicos autorizados pueden reparar esta iluminación!



PELIGRO

¡Riesgo de descarga eléctrica debido a piezas con tensión!

Peligro mortal por descarga eléctrica en caso de reparación inadecuada

- Las piezas eléctricas deberían ser reparadas por electricistas cualificados.
- Después de la reparación, encargar una prueba de seguridad conforme a VDE 0701 o los reglamentos específicos del país.



PELIGRO

¡Riesgo de descarga eléctrica debido a partes con tensión!

Muerte por electrocución

- Desconectar el aparato de la red al menos 60 segundos antes de comenzar con la reparación.



PRECAUCIÓN

¡Bordes o cantos cortantes!

Peligro de cortes

- Usar guantes de seguridad.

Requisito:

- El aparato está desconectado del suministro eléctrico.
- La puerta está abierta.
- Se han retirado los estantes del refrigerador.

4.17.1 Desmontar el foco LED

- Soltar la tapa del foco LED.

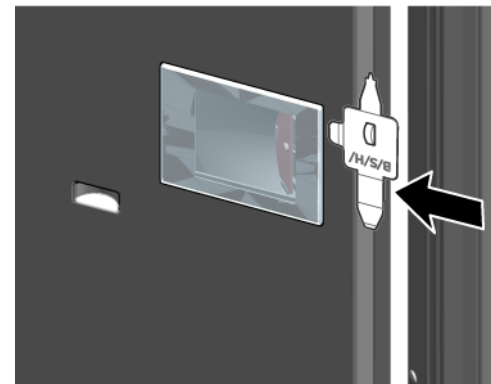

- Tirar de la tapa del foco LED hacia dentro y al mismo tiempo presionar hacia delante.

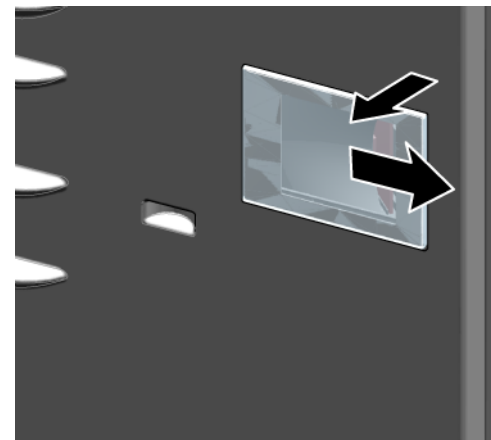

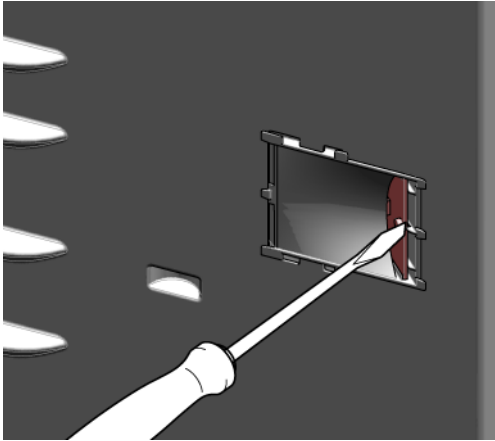

Reparación

3. Desacoplar el módulo del foco LED.

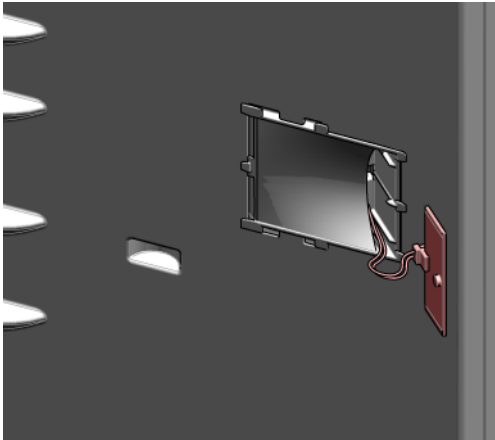

4. Desconectar la conexión eléctrica del foco LED.



-  Se ha retirado el foco LED.

4.17.2 Montar el foco LED

- ▶ Montar en orden inverso.

Reparationsinformation - Kyl-/ fryskombination

 Om detta dokument	641
1.1 Viktig information.....	641
1.1.1 Syfte	641
1.2 Symbolförklaringar.....	641
1.2.1 Faronivåer	641
1.2.2 Risksymboler.....	641
1.2.3 Varningarnas struktur.....	642
1.2.4 Allmänna symboler.....	642
 Säkerhet	643
2.1 Allmänna säkerhetsanvisningar	643
2.1.1 Alla hushållsmaskiner.....	643
 Verktyg och hjälpmedel	644
 Reparation	645
4.1 Byta dörrpackning.....	645
4.1.1 Ta bort dörrpackning	645
4.1.2 Montera dörrpackning	645
4.2 Byta dörrhandtag.....	648
4.2.1 Ta bort dörrhandtag	648
4.2.2 Montera dörrhandtag.....	648
4.3 Byta dörrens övre gångjärn	649
4.3.1 Ta bort dörrens övre gångjärn.....	649
4.3.2 Montera dörrens övre gångjärn	650
4.4 Byta dörrens övre gångjärn (dörr med display)	651
4.4.1 Ta bort dörrens övre gångjärn.....	651
4.4.2 Montera dörrens övre gångjärn	652
4.5 Byta dörrens mellersta gångjärn	653
4.5.1 Ta bort dörrens mellersta gångjärn.....	653
4.5.2 Montera dörrens mellersta gångjärn	653
4.6 Byta dörrens nedre gångjärn	654
4.6.1 Ta bort dörrens nedre gångjärn.....	654
4.6.2 Montera dörrens nedre gångjärn	654
4.7 Byta hylla	655
4.7.1 Ta bort hylla.....	655
4.7.2 Montera hylla.....	655

4.8 Byta flaskhylla.....	656
4.8.1 Ta bort flaskhylla	656
4.8.2 Montera flaskhylla	656
4.9 Byta dörrhylla.....	657
4.9.1 Ta bort dörrhylla	657
4.9.2 Montera dörrhylla	657
4.10 Byta justerbar dörrhylla.....	658
4.10.1 Ta bort justerbar dörrhylla	658
4.10.2 Montera justerbar dörrhylla	658
4.11 Byta fack för frysta matvaror	659
4.11.1 Ta bort fack för frysta matvaror.....	659
4.11.2 Montera fack för frysta matvaror	659
4.12 Byta fack	660
4.12.1 Ta bort fack.....	660
4.12.2 Montera låda	660
4.13 Byta utdragbar låda	661
4.13.1 Ta bort utdragbar låda	661
4.13.2 Montera utdragbar låda.....	661
4.14 Byta LED-spotlight	662
4.14.1 Ta bort LED-spotlight.....	662
4.14.2 Montera LED-spotlight	662
4.15 Byta översta LED-lampan.....	663
4.15.1 Ta bort LED-lampan	663
4.15.2 Montera översta LED-lampan.....	664
4.16 Byta LED-sidoramplampa	665
4.16.1 Ta bort LED-sidoramplampa	665
4.16.2 Montera LED-sidoramplampa.....	666
4.17 Byta LED-spotlight	667
4.17.1 Ta bort LED-spotlight.....	667
4.17.2 Montera LED-spotlight	668

i Om detta dokument

1.1 Viktig information

1.1.1 Syfte

Dessa reparationstips hjälper kunden att själv reparera maskiner enligt gällande ekodesignbestämmelser (som gäller 03/2021).





De innehåller information om hur vissa reservdelar ska bytas samt tillhörande varningar och risker.

Kontakta vår kundtjänst om du har frågor. Vi åtar oss bara ansvar för skador om reparationstipsen har följts korrekt.

1.2 Symbolförklaringar

1.2.1 Faronivåer

Varningsnivåerna består av en symbol och ett signalord. Signalordet visar hur allvarlig faran är.





Varningsnivå	Innebörd
	Om inte varningsmeddelandet följs kommer det att leda till dödsfall eller allvarliga personskador.
	Om inte varningsmeddelandet följs kan det leda till dödsfall eller allvarliga personskador.
	Om inte varningsmeddelandet följs kan det leda till lättare personskador.
	Om inte varningsmeddelandet följs kan det leda till materialskador.

Grafik 1: Faronivåer



1.2.2 Risksymboler

Risksymboler är symboler som visar typen av fara.

Följande risksymboler används i detta dokument:

Risksymbol	Innebörd
	Allmänt varningsmeddelande
	Fara på grund av elektrisk spänning
	Explosionsrisk
	Fara för skärskador
	Fara för krosskador

i Om detta dokument

Risksymbol	Innebörd
	Fara på grund av heta ytor
	Fara på grund av starka magnetfält
	Fara på grund av icke-joniserande strålning

Grafik 2: Risksymboler

1.2.3 Varningarnas struktur

Varningar i detta dokument har ett standardiserat utseende och en standardiserad struktur.



	<p> FARA!</p> <p>Farans typ och ursprung! Möjliga konsekvenser av att faran/varningen ignoreras.</p> <ul style="list-style-type: none"> ▶ Åtgärder och förbud för att förebygga faran.
--	--





Följande exempel visar en varning som varnar för elstötar från strömförande delar. Det står vilken åtgärd som förebygger faran.

	<p> FARA!</p> <p>Risk för elstötar på grund av strömförande delar! Dödsfall på grund av elstötar</p> <ul style="list-style-type: none"> ▶ Koppla bort maskiner från elförsörjningen minst 60 sekunder innan reparationer påbörjas.
---	---

1.2.4 Allmänna symboler

Följande allmänna symboler används i detta dokument:

Allm. symbol	Innebörd
	Identifiering av ett särskilt tips (text och/eller bild)
	Identifiering av ett enkelt tips (endast text)

Allm. symbol	Innebörd
	Identifiering av en länk till en videohandledning
	Identifiering av verktyg som behövs
	Identifiering av villkor som måste vara uppfyllda
	Identifiering av ett tillstånd (om ..., så ...)
	Identifiering av ett resultat
[Start]	Identifiering av en tangent eller knapp
[00123456]	Identifiering av ett materialnummer
Status	Identifiering av text/fönster som visas (i maskinens display)

Grafik 3: Allmänna symboler

2.1 Allmänna säkerhetsanvisningar

2.1.1 Alla hushållsmaskiner

Risk för elstötar på grund av strömförande delar!

- Fel vid reparationer som berör elkomponenter kan orsaka elstötar!
- Koppla bort maskinen från elnätet minst 60 sekunder innan arbetet påbörjas.
- Låt utföra ett säkerhetstest efter reparationen, i enlighet med VDE 0701 eller landsspecifika regler.

Risk för personskador på grund av vassa kanter!

- Använd skyddshandskar.

Risk för krosskador vid reparation, underhåll, felsökning och service på grund av tunga och rörliga komponenter

- Använd skyddsskor.
- Säkra tunga komponenter så att de inte faller ner.
- Stick inte in kroppsdelar i rörliga komponenter.





Risk för maskinens säkerhet/funktion!

- Använd endast originaldelar.

Risk för skador på komponenter känsliga för statisk elektricitet (ESD)!

- Rör inte modulerna samt anslutningar och strömförande ledningar.

Verkt yg och hj alpmedel

Beteckning	Detaljer	Bilder
Skyddstrasa [00342013]	60 cm x 50 cm	
Sp�arskruvmejsel	Blad 2,4 mm x 0,4 mm x 60 mm, i kitet [00341820]	
Specialverkt�yg [00342180]		
Sugkopp [00342224]	�50 mm	
Torxbits TX20 [00340865]	6,3 mm (1/4")	
Sp�arskruvmejsel	Blad 10 mm x 1,6 mm x 200 mm	

4.1 Byta dörrpackning

Förutsättning:

- ✔ Dörren är öppen.

4.1.1 Ta bort dörrpackning

1. Lossa dörrpackningen från spåret i högra och vänstra hörnet.

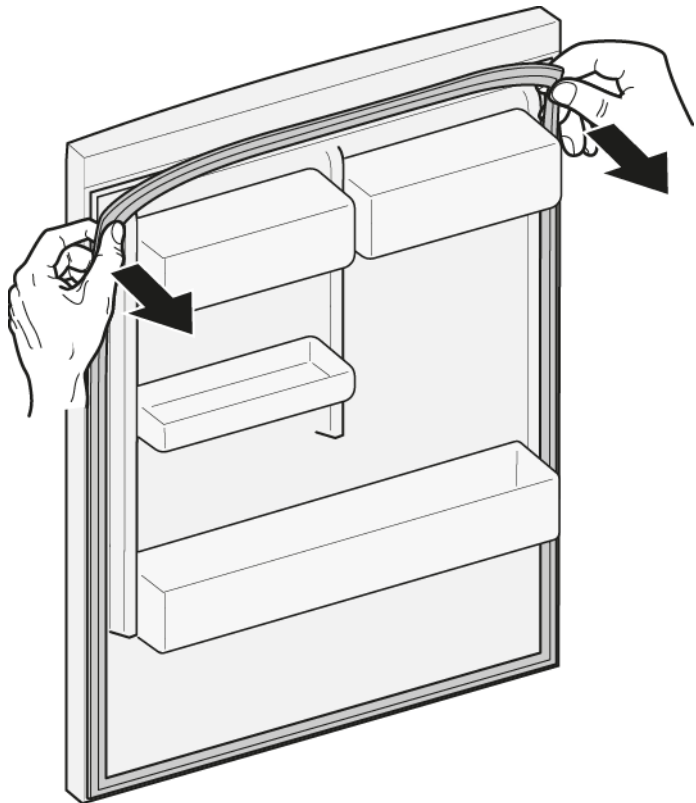

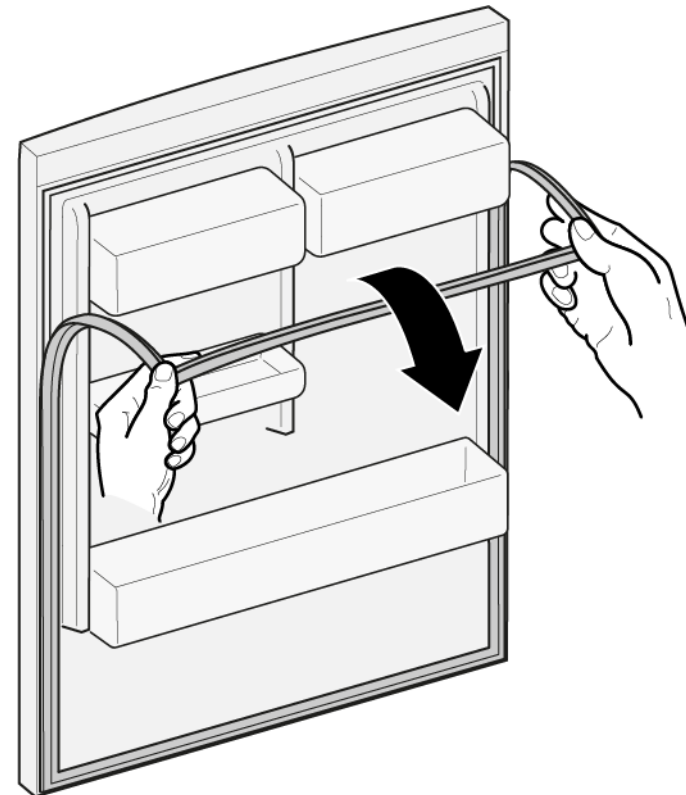

2. Dra ut dörrpackningen från spåret.



- ➡ Dörrpackningen har tagits bort.

4.1.2 Montera dörrpackning

	Den nya dörrpackningens tjocklek kan avvika något från den gamla dörrpackningens tjocklek. Detta kommer inte påverka stängningsegenskaperna eller funktionen långsiktigt.
	Om apparaten har justerbara gångjärn eller gångjärnsfästen kan du optimera stängningsegenskaperna senare.
	Små sidohål i dörrpackningen fyller en funktion (krävs för ventilation). Dessa utgör inga tillverkningsfel.

Reparation

1. Kontrollera om spåret för packningen har skador.

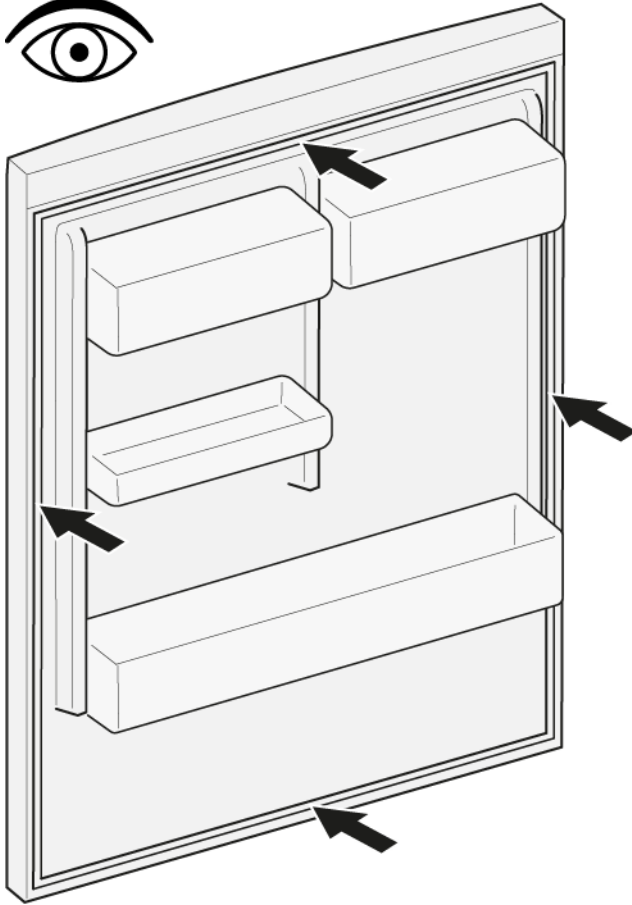

4. Tryck in packningens hörn längst upp och längst ner i spåret.

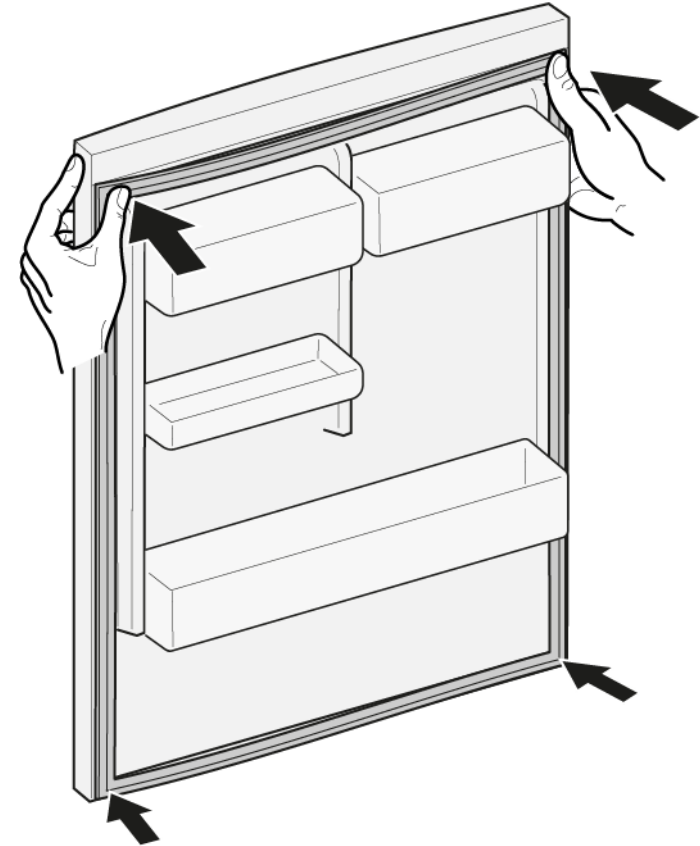

2.  Om spåret för packningen är skadat:
 - Kontakta kundtjänst.

3.  Viss deformation av dörrpackningen är normalt och påverkar inte packningens funktion. Det rekommenderas att man sträcker dörrpackningen innan den sätts in i apparaten.

Värm dörrpackningen med en hårtork eller hett vatten och forma om den med händerna.

Reparation

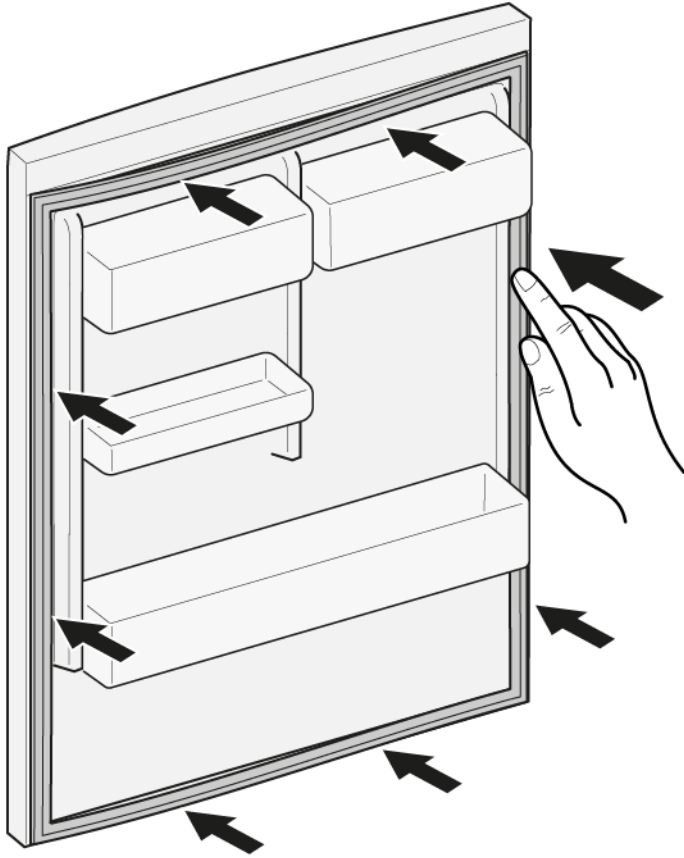

5. Tryck in hela packningen i spåret bit för bit.





 Dörrpackningen är monterad.

4.2 Byta dörrhandtag

Nödvändiga verktyg:

-  Torxbits TX20 6,3 mm (1/4") [00340865]
-  Spårskruvmejsel Blad 10 mm x 1,6 mm x 200 mm

Förutsättning:

-  Apparaten är bortkopplad från strömförsörjning.
-  Dörren är öppen.

4.2.1 Ta bort dörrhandtag

- ▶ 1. Ta bort de två skruvhättorna (1).
- ▶ 2. Skruva ur de två skruvarna (2).
- ▶ 3. Ta bort dörrhandtaget (3).

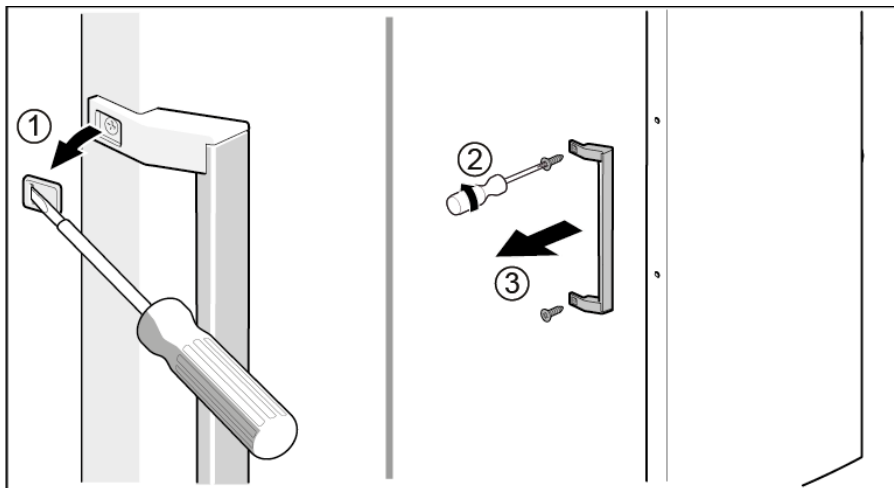

 Dörrhandtaget har tagits bort.



Dörrhandtaget för den andra dörren kan tas bort på samma sätt.

4.2.2 Montera dörrhandtag

- ▶ Montera i omvänd ordning.

4.3 Byta dörrens övre gångjärn

Nödvändiga verktyg:

Torxbits TX20

6,3 mm (1/4")

[00340865]

	⚠ VARNING! Tunga och skrymmande apparater! Rygg- och muskelskador ▶ Låt endast utbildad personal ta bort dörren från apparaten. ▶ Det krävs två personer för att flytta apparaten. ▶ Använd endast passande verktyg och utrustning.
	⚠ FÖRSIKTIGT! Vassa kanter! Skärskador ▶ Använd skyddshandskar.
	⚠ VARNING! Lutande maskiner kan glida! Frakturer/krosskador ▶ Säkra maskiner så att de inte kan glida.
	⚠ FÖRSIKTIGT! Risk för fallande delar på grund av lossade skruvar! Personskador på grund av fallande delar. ▶ Säkra komponenter så att de inte faller ner.
	OBS! Risk för fallande delar på grund av lossade skruvar! Materiella skador på andra delar av maskinen eller i kundens hem, t.ex. vid botten. ▶ Säkra komponenter så att de inte faller ner.

Förutsättning:

- ✓ Apparaten är bortkopplad från strömförsörjning.
- ✓ Tillbehör inuti apparaten har tagits bort.

4.3.1 Ta bort dörrens övre gångjärn

1. Lägg ner apparaten på baksidan.

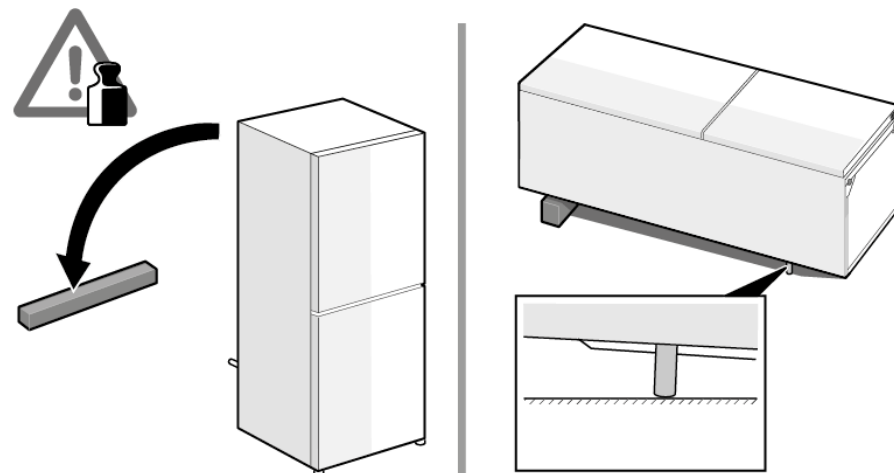

Reparation

2. 1. Tryck på det övre gångjärnsskyddet på båda sidor (1).
2. Flytta ut det övre gångjärnsskyddet (2).
3. Vrid gångjärnsskyddet (3).
4. Ta bort det övre gångjärnsskyddet (4).
5. Skruva ur de två skruvarna (5).
6. Ta bort det övre gångjärnet (6)/

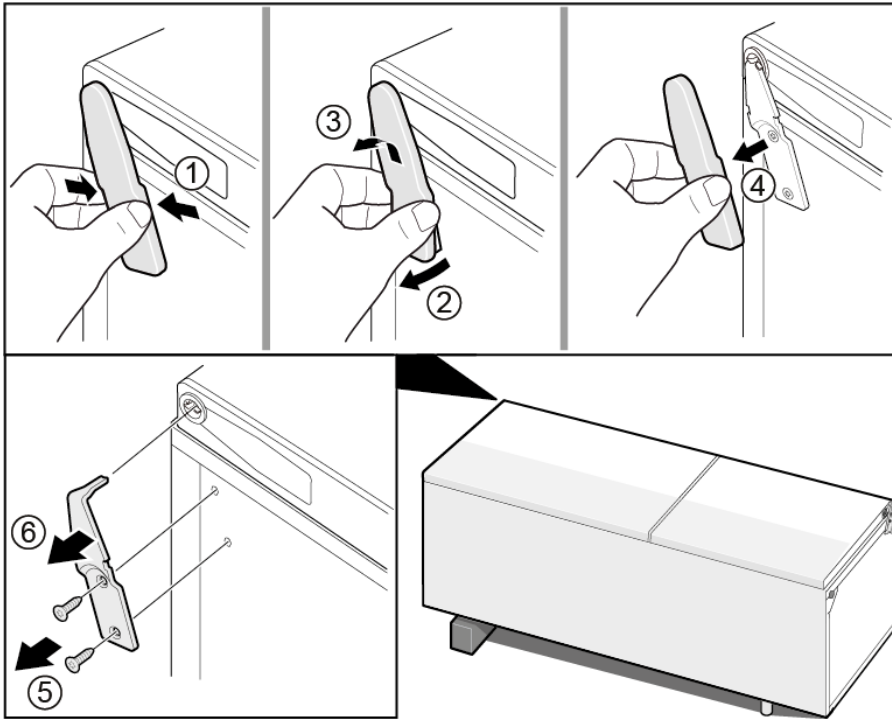

 Det övre gångjärnet har tagits bort.

4.3.2 Montera dörrens övre gångjärn

- ▶ Montera i omvänd ordning.

4.4 Byta dörrens övre gångjärn (dörr med display)

Nödvändiga verktyg:

Torxbits TX20

6,3 mm (1/4")

[00340865]

	<p>⚠ VARNING!</p> <p>Tunga och skrymmande apparater! Rygg- och muskelskador</p> <ul style="list-style-type: none"> ▶ Låt endast utbildad personal ta bort dörren från apparaten. ▶ Det krävs två personer för att flytta apparaten. ▶ Använd endast passande verktyg och utrustning.
	<p>⚠ FÖRSIKTIGT!</p> <p>Vassa kanter! Skärskador</p> <ul style="list-style-type: none"> ▶ Använd skyddshandskar.
	<p>⚠ VARNING!</p> <p>Lutande maskiner kan glida! Frakturer/krosskador</p> <ul style="list-style-type: none"> ▶ Säkra maskiner så att de inte kan glida.
	<p>⚠ FÖRSIKTIGT!</p> <p>Risk för fallande delar på grund av lossade skruvar! Personskador på grund av fallande delar.</p> <ul style="list-style-type: none"> ▶ Säkra komponenter så att de inte faller ner.
	<p>OBS!</p> <p>Risk för fallande delar på grund av lossade skruvar! Materiella skador på andra delar av maskinen eller i kundens hem, t.ex. vid botten.</p> <ul style="list-style-type: none"> ▶ Säkra komponenter så att de inte faller ner.

	<p>⚠ FARA!</p> <p>Risk för elstötar på grund av strömförande delar! Livsfara på grund av elstötar vid felaktiga reparationer</p> <ul style="list-style-type: none"> ▶ Elektriska delar ska repareras av behörig elektriker. ▶ Låt utföra ett säkerhetstest efter reparationen, i enlighet med VDE 0701 eller landsspecifika regler.
---	---

	<p>⚠ FARA!</p> <p>Risk för elstötar på grund av strömförande delar! Dödsfall på grund av elstötar</p> <ul style="list-style-type: none"> ▶ Koppla bort maskiner från elförsörjningen minst 60 sekunder innan reparationer påbörjas.
---	--

Förutsättning:

- ✓ Apparaten är bortkopplad från strömförsörjning.
- ✓ Tillbehör inuti apparaten har tagits bort.

4.4.1 Ta bort dörrens övre gångjärn

1. Lägg ner apparaten på baksidan.

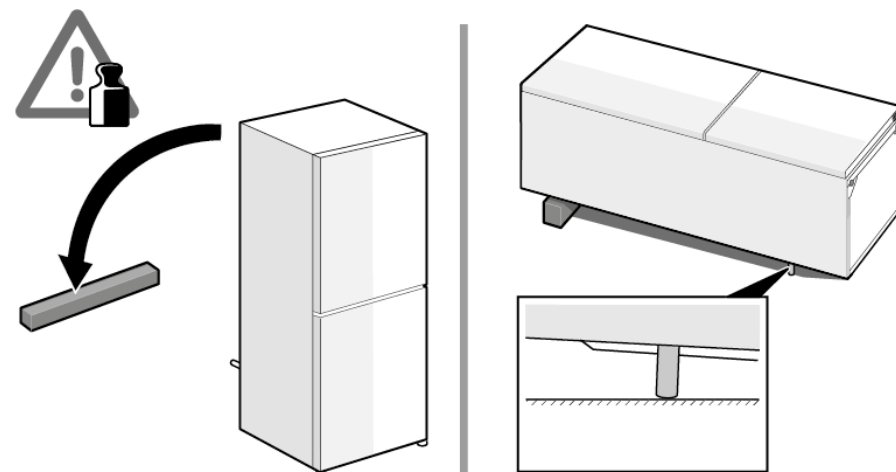

Reparation

2. 1. Ta bort det övre gångjärnsskyddet (1).
2. Ta bort kabelboxhöljet (2).
3. Lossa elanslutningen (3).
4. Skruva ur jordanslutningsskruven (4).
5. Ta bort kabelskyddet (5).
6. Skruva ur skruven (6)

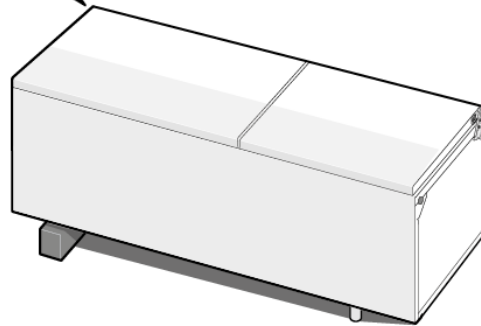
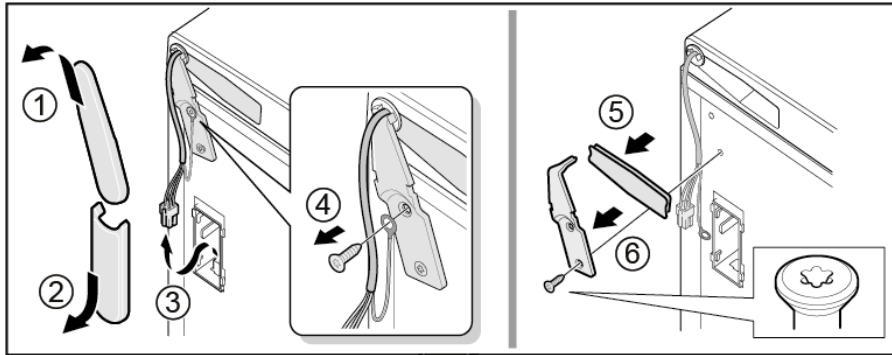

 Det övre gångjärnet har tagits bort.

4.4.2 Montera dörrens övre gångjärn

- ▶ Montera i omvänd ordning.

4.5 Byta dörrens mellersta gångjärn

Nödvändiga verktyg:

Torxbits TX20

6,3 mm (1/4")

[00340865]

	⚠ VARNING!
	Tunga och skrymmande apparater! Rygg- och muskelskador ▶ Låt endast utbildad personal ta bort dörren från apparaten. ▶ Det krävs två personer för att flytta apparaten. ▶ Använd endast passande verktyg och utrustning.

	⚠ FÖRSIKTIGT!
	Vassa kanter! Skärskador ▶ Använd skyddshandskar.

	⚠ VARNING!
	Lutande maskiner kan glida! Frakturer/krosskador ▶ Säkra maskiner så att de inte kan glida.

	⚠ FÖRSIKTIGT!
	Risk för fallande delar på grund av lossade skruvar! Personskador på grund av fallande delar. ▶ Säkra komponenter så att de inte faller ner.

	OBS!
	Risk för fallande delar på grund av lossade skruvar! Materiella skador på andra delar av maskinen eller i kundens hem, t.ex. vid botten. ▶ Säkra komponenter så att de inte faller ner.

Förutsättning:

- ✓ Apparaten är bortkopplad från strömförsörjning.
- ✓ Tillbehör inuti apparaten har tagits bort.
- ✓ Dörrens övre gångjärn har tagits bort.

4.5.1 Ta bort dörrens mellersta gångjärn

- ▶ 1. Ta bort kyldelens dörr (1).
- ▶ 2. Skruva ur de två skruvarna (2).
- ▶ 3. Ta bort det mellersta gångjärnet (3).

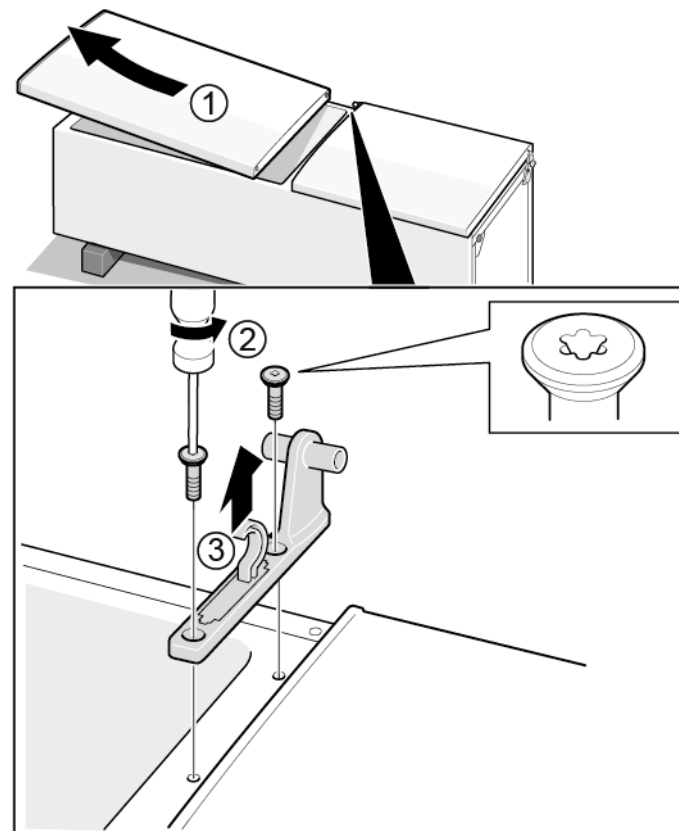

➡ Det mellersta gångjärnet har tagits bort.

4.5.2 Montera dörrens mellersta gångjärn

- ▶ Montera i omvänd ordning.

4.6 Byta dörrens nedre gångjärn

Nödvändiga verktyg:

Torxbits TX20

6,3 mm (1/4")

[00340865]

	⚠ VARNING! Tunga och skrymmande apparater! Rygg- och muskelskador ▶ Låt endast utbildad personal ta bort dörren från apparaten. ▶ Det krävs två personer för att flytta apparaten. ▶ Använd endast passande verktyg och utrustning.
	⚠ FÖRSIKTIGT! Vassa kanter! Skärskador ▶ Använd skyddshandskar.
	⚠ VARNING! Lutande maskiner kan glida! Frakturer/krosskador ▶ Säkra maskiner så att de inte kan glida.
	⚠ FÖRSIKTIGT! Risk för fallande delar på grund av lossade skruvar! Personskador på grund av fallande delar. ▶ Säkra komponenter så att de inte faller ner.
	OBS! Risk för fallande delar på grund av lossade skruvar! Materiella skador på andra delar av maskinen eller i kundens hem, t.ex. vid botten. ▶ Säkra komponenter så att de inte faller ner.

Förutsättning:

- ✓ Apparaten är bortkopplad från strömförsörjning.
- ✓ Tillbehör inuti apparaten har tagits bort.
- ✓ Det övre gångjärnet har tagits bort.
- ✓ Det mellersta gångjärnet har tagits bort.

4.6.1 Ta bort dörrens nedre gångjärn

- ▶ 1. Ta bort frysdelens dörr (1).
- ▶ 2. Skruva ur skruven (2).
- ▶ 3. Vrid ut det nedre gångjärnet (3).
- ▶ 4. Ta bort det nedre gångjärnet (4).

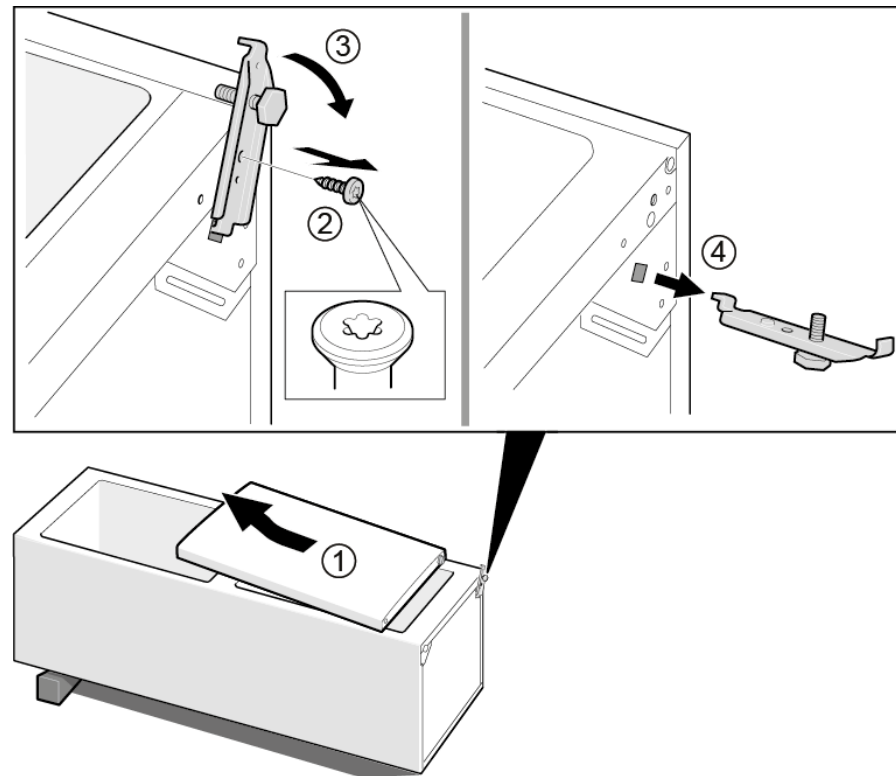

- ➡ Dörrens nedre gångjärn har tagits bort.

4.6.2 Montera dörrens nedre gångjärn

- ▶ Montera i omvänd ordning.

4.7 Byta hylla

Förutsättning:

- ✔ Dörren är öppen.

4.7.1 Ta bort hylla

- ▶ Dra ut hyllan.

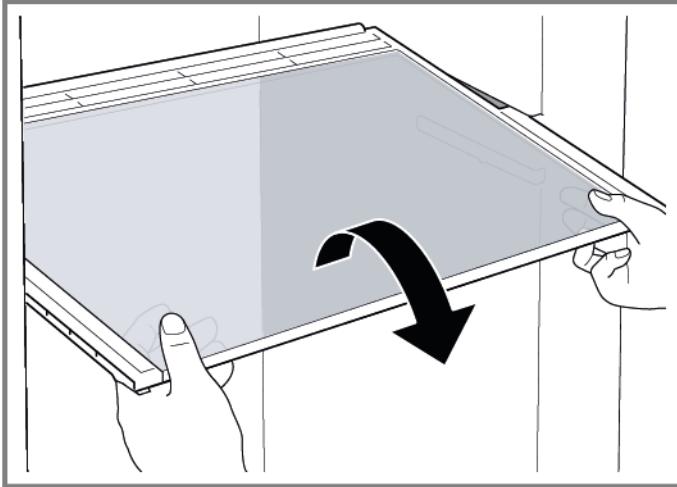

- ➡ Hyllan har tagits bort.

4.7.2 Montera hylla

- ▶ Montera i omvänd ordning.

4.8 Byta flaskhylla

Förutsättning:

- ✓ Dörren är öppen.

4.8.1 Ta bort flaskhylla

- ▶ Dra ut flaskhyllan.

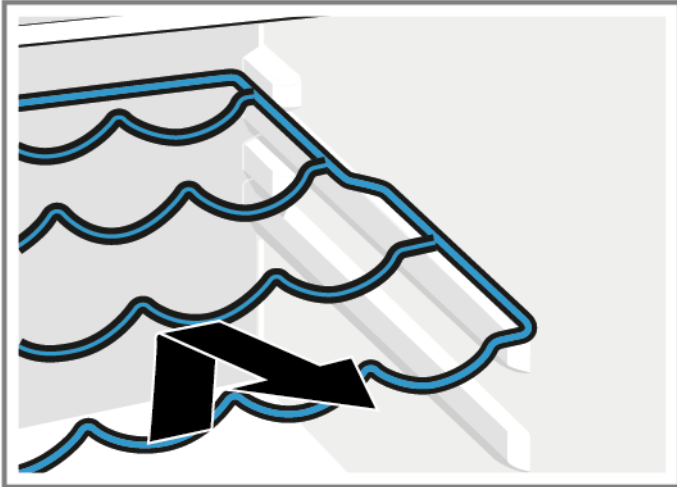

- ➡ Flaskhyllan har tagits bort.

4.8.2 Montera flaskhylla

- ▶ Montera i omvänd ordning.

4.9 Byta dörrhylla

Förutsättning:

- ✔ Dörren är öppen.

4.9.1 Ta bort dörrhylla

- ▶ Lyft dörrhyllan uppåt.

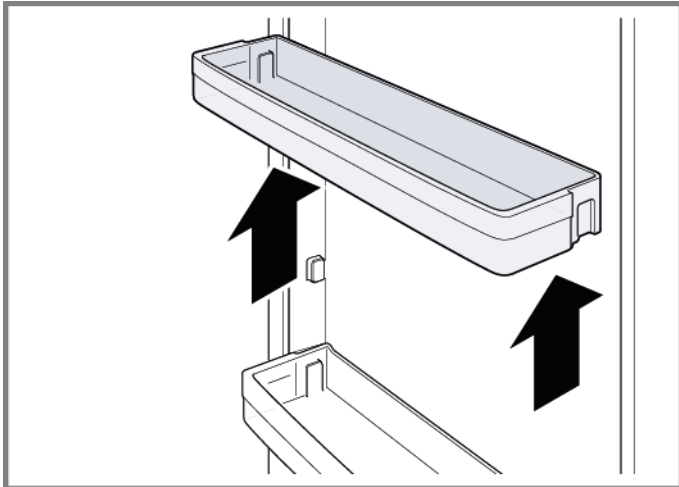

➡ Dörrhyllan har tagits bort.

4.9.2 Montera dörrhylla

- ▶ Montera i omvänd ordning.

4.10 Byta justerbar dörrhylla

Förutsättning:

- ✓ Dörren är öppen.

4.10.1 Ta bort justerbar dörrhylla

- ▶ Flytta den höjdjusterbara dörrhyllan uppåt tills dörrhyllan lossnar från hållaren.

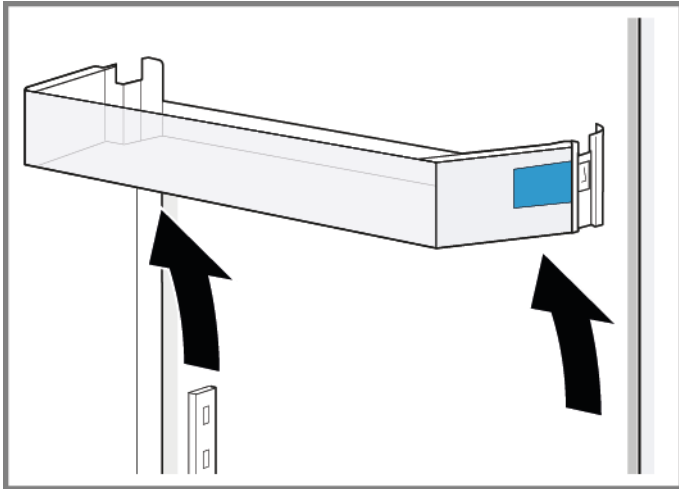

- ➡ Den justerbara dörrhyllan har tagits bort.

4.10.2 Montera justerbar dörrhylla

- ▶ Montera i omvänd ordning.

4.11 Byta fack för frysta matvaror

Förutsättning:

- ✔ Dörren är öppen.

4.11.1 Ta bort fack för frysta matvaror

- ▶ 1. Dra ut facket för frysta matvaror helt (1).
- ▶ 2. Ta bort facket för matvaror (2).

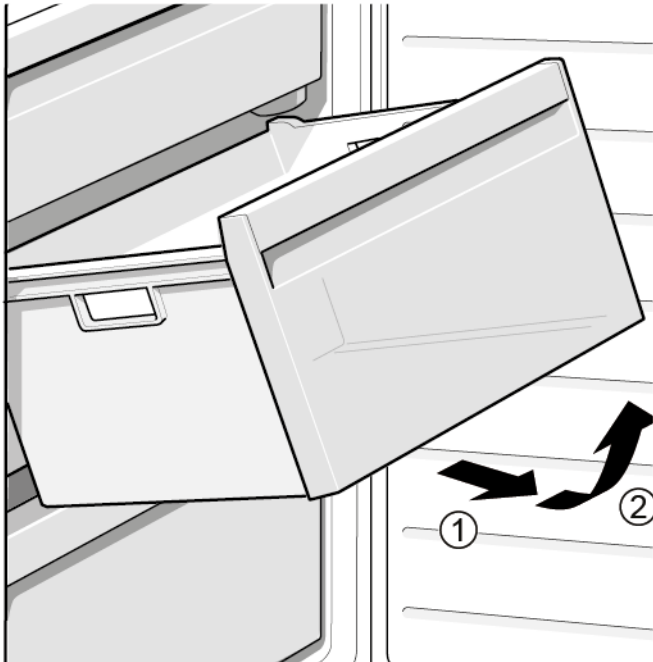

- ➡ Facket för frysta matvaror har tagits bort.

4.11.2 Montera fack för frysta matvaror

- ▶ Montera i omvänd ordning.

4.12 Byta fack

Förutsättning:

- ✔ Dörren är öppen.

4.12.1 Ta bort fack

- ▶ 1. Ta ut det nedre kylfacket (1).
- ▶ 2. Ta ut det övre kylfacket (2).

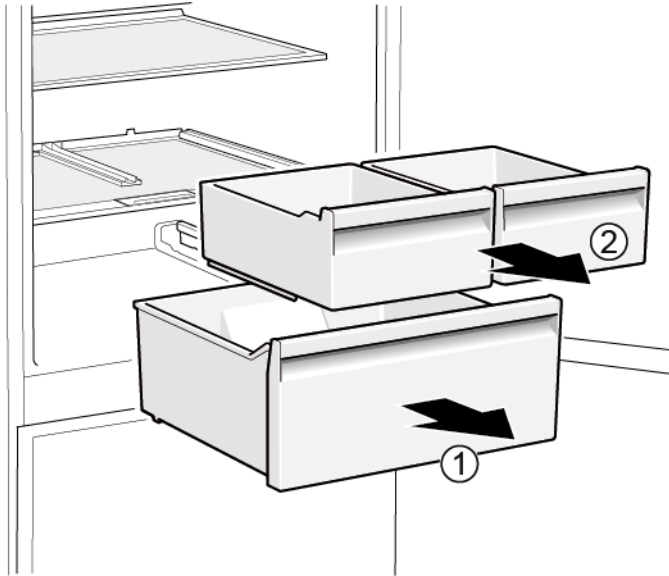

- ➡ Facken har tagits bort.

4.12.2 Montera låda

- ▶ Montera i omvänd ordning.

4.13 Byta utdragbar låda

Förutsättning:

- ✓ Dörren är öppen.

4.13.1 Ta bort utdragbar låda

- ▶ 1. Dra ut den utdragbara lådan helt (1).
- ▶ 2. Ta bort den utdragbara lådan (2).

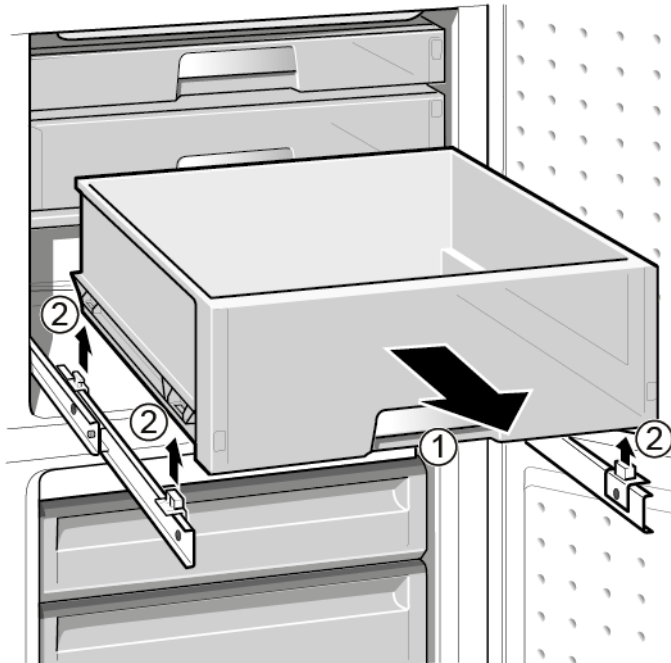

- ➡ Den utdragbara lådan har tagits bort.

4.13.2 Montera utdragbar låda

- ▶ Montera i omvänd ordning.

4.14 Byta LED-spotlight

Nödvändiga verktyg:

Specialverktyg

[00342180]



Din apparat har en underhållsfri LED-lampa. Dessa lampor får endast bytas av kundtjänst eller auktoriserade tekniker!



FARA!

Risk för elstötar på grund av strömförande delar!

Livs fara på grund av elstötar vid felaktiga reparationer

- ▶ Elektriska delar ska repareras av behörig elektriker.
- ▶ Låt utföra ett säkerhetstest efter reparationen, i enlighet med VDE 0701 eller landsspecifika regler.



FARA!

Risk för elstötar på grund av strömförande delar!

Dödsfall på grund av elstötar

- ▶ Koppla bort maskiner från elförsörjningen minst 60 sekunder innan reparationer påbörjas.



FÖRSIKTIGT!

Vassa kanter!

Skärskador

- ▶ Använd skyddshandskar.

Förutsättning:

- ✔ Apparaten är bortkopplad från strömförsörjning.
- ✔ Dörren är öppen.

4.14.1 Ta bort LED-spotlight

1. Använd specialverktyg för att dra ut LED-spotlighten (1).

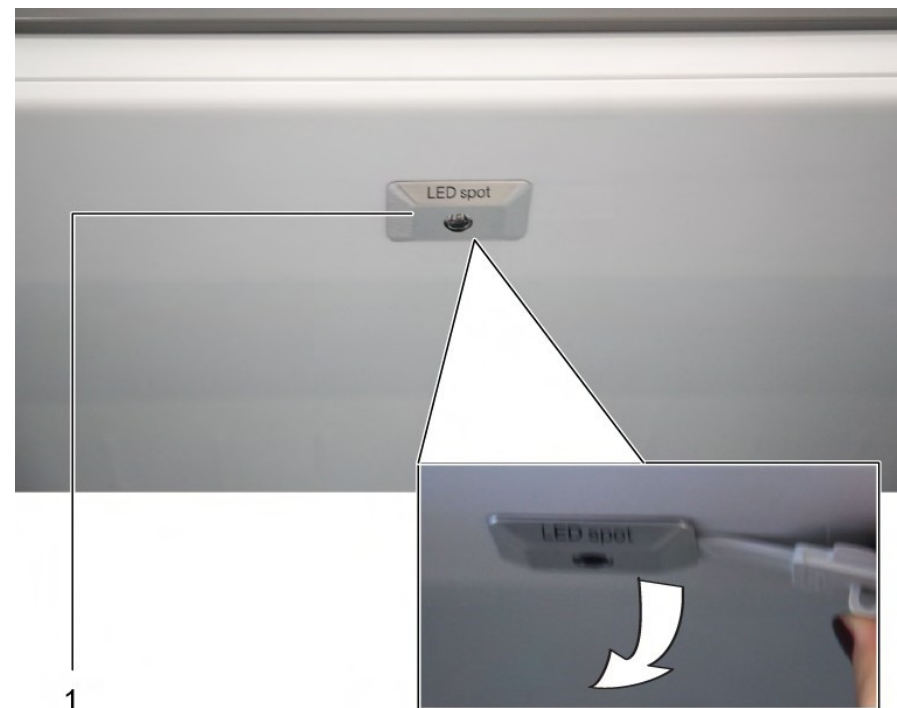

2. Lossa elanslutningarna till LED-spotlighten.

➡ LED-spotlighten har tagits bort.

4.14.2 Montera LED-spotlight

- ▶ Montera i omvänd ordning.

4.15 Byta översta LED-lampan

Nödvändiga verktyg:

Spårskruvmejsel

Blad 2,4 mm x 0.4 mm x 60 mm, i kitet [00341820]

i Din apparat har en underhållsfri LED-lampa. Dessa lampor får endast bytas av kundtjänst eller auktoriserade tekniker!



FARA!

Risk för elstötar på grund av strömförande delar!

Livsfara på grund av elstötar vid felaktiga reparationer

- ▶ Elektriska delar ska repareras av behörig elektriker.
- ▶ Låt utföra ett säkerhetstest efter reparationen, i enlighet med VDE 0701 eller landsspecifika regler.



FARA!

Risk för elstötar på grund av strömförande delar!

Dödsfall på grund av elstötar

- ▶ Koppla bort maskiner från elförsörjningen minst 60 sekunder innan reparationer påbörjas.



FÖRSIKTIGT!

Vassa kanter!

Skärskador

- ▶ Använd skyddshandskar.

Förutsättning:

- ✓ Apparaten är bortkopplad från strömförsörjning.
- ✓ Dörren är öppen.
- ✓ Tillbehör överst inuti apparaten har tagits bort.

4.15.1 Ta bort LED-lampan

1. Flytta LED-lampan åt vänster.

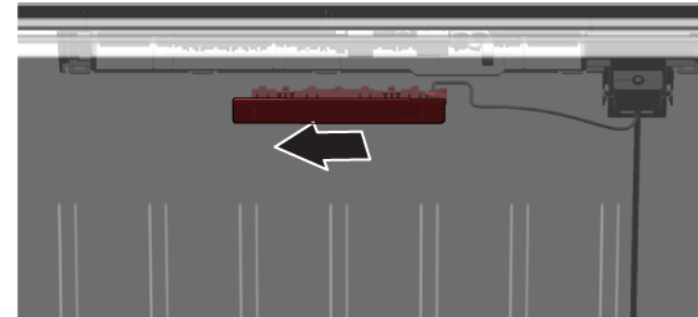

LED-lampans elanslutning är bortkopplad.

2. Lossa LED-lampans hakar.

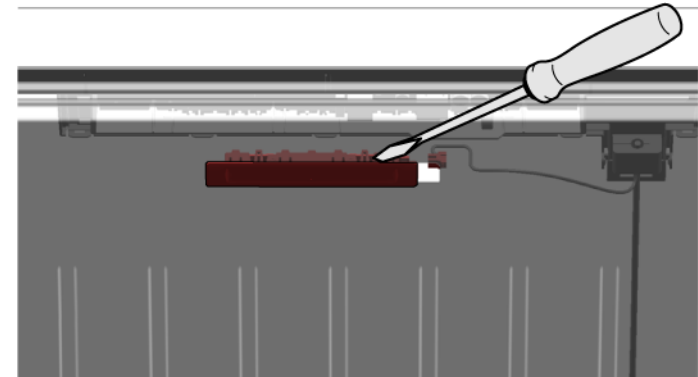

Reparation

3. Ta bort LED-lampan genom att flytta den framåt.

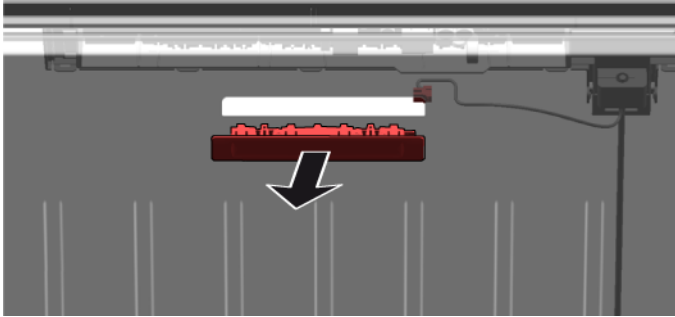

- ➔ LED-lampan har tagits bort.

4.15.2 Montera översta LED-lampan

- ▶ Montera i omvänd ordning.

4.16 Byta LED-sidoramplampa

Nödvändiga verktyg:

Sugkopp Ø50 mm [00342224]



Din apparat har en underhållsfri LED-lampa. Dessa lampor får endast bytas av kundtjänst eller auktoriserade tekniker!



FARA!

Risk för elstötar på grund av strömförande delar!

Livs fara på grund av elstötar vid felaktiga reparationer

- ▶ Elektriska delar ska repareras av behörig elektriker.
- ▶ Låt utföra ett säkerhetstest efter reparationen, i enlighet med VDE 0701 eller landsspecifika regler.



FARA!

Risk för elstötar på grund av strömförande delar!

Dödsfall på grund av elstötar

- ▶ Koppla bort maskiner från elförsörjningen minst 60 sekunder innan reparationer påbörjas.



FÖRSIKTIGT!

Vassa kanter!

Skärskador

- ▶ Använd skyddshandskar.

Förutsättning:

- ✓ Apparaten är bortkopplad från strömförsörjning.
- ✓ Dörren är öppen.
- ✓ Kylidelshyllorna har tagits bort.

4.16.1 Ta bort LED-sidoramplampa

1. Sätt sugkoppen på den övre tredjedelen av LED sidoramplaman.



Reparation

2. Dra sugkoppen framåt med LED-sidoramplampan i en vridrörelse.

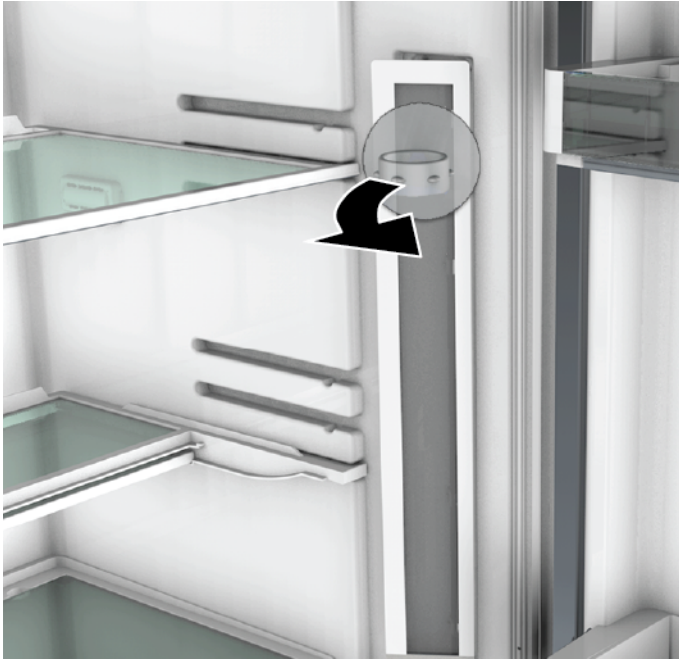

3. Lossa elanslutningen till LED-sidoramplampan.
 LED-sidoramplampan har tagits bort.

4.16.2 Montera LED-sidoramplampa

1. Anslut elanslutningen till LED-sidoramplampan.
 2. Sätt fast LED-sidoramplampan på dess plats på kyldelsväggen (hakarna klickar i).
-  LED-sidoramplampan har monterats.

4.17 Byta LED-spotlight

Nödvändiga verktyg:

- Specialverktyg [00342180]
- Spårskruvmejsel Blad 2,4 mm x 0.4 mm x 60 mm, i kitet [00341820]

i Din apparat har en underhållsfri LED-lampa. Dessa lampor får endast bytas av kundtjänst eller auktoriserade tekniker!



FARA!

Risk för elstötar på grund av strömförande delar!

Livs fara på grund av elstötar vid felaktiga reparationer

- ▶ Elektriska delar ska repareras av behörig elektriker.
- ▶ Låt utföra ett säkerhetstest efter reparationen, i enlighet med VDE 0701 eller landsspecifika regler.



FARA!

Risk för elstötar på grund av strömförande delar!

Dödsfall på grund av elstötar

- ▶ Koppla bort maskiner från elförsörjningen minst 60 sekunder innan reparationer påbörjas.



FÖRSIKTIGT!

Vassa kanter!

Skärskador

- ▶ Använd skyddshandskar.

Förutsättning:

- ✓ Apparaten är bortkopplad från strömförsörjning.
- ✓ Dörren är öppen.
- ✓ Kyldelehyllorna har tagits bort.

4.17.1 Ta bort LED-spotlight

1. Lossa LED-spotlightens hölje.

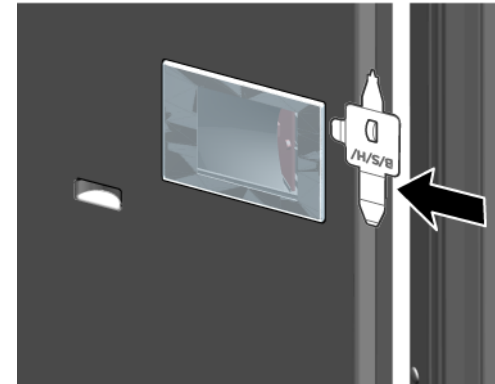

2. Dra LED-spotlightens hölje inåt och tryck samtidigt framåt.

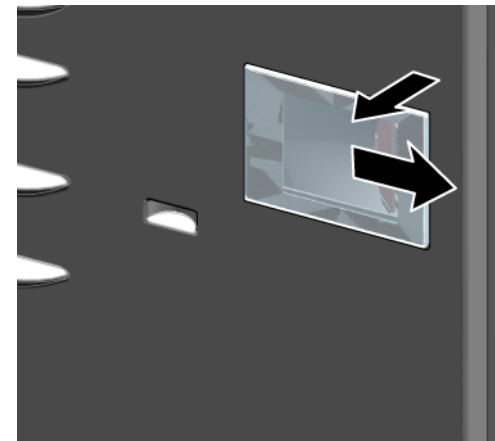

Reparation

3. Ta loss LED-spotlightmodulen.

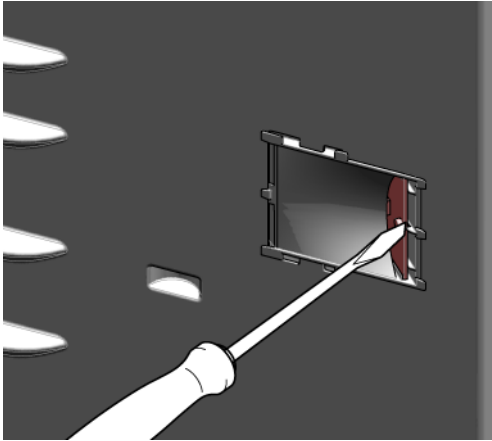

4. Lossa LED-spotlightens elanslutning.

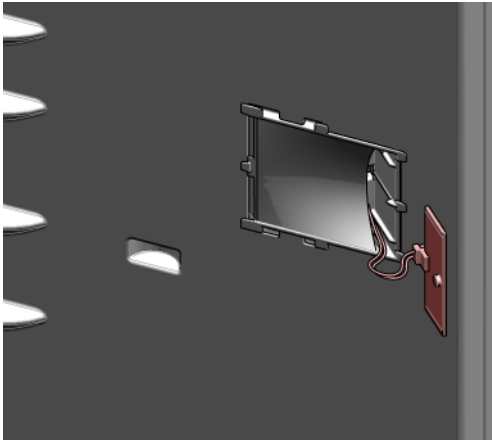

 LED-spotlighten har tagits bort.

4.17.2 Montera LED-spotlight

▶ Montera i omvänd ordning.

Onarım İpuçları - Soğutucu/Dondurucu kombine cihazı

i	Bu doküman hakkında	670
1.1	Önemli bilgi	670
1.1.1	Amacı	670
1.2	Sembollerinin açıklaması	670
1.2.1	Tehlike kademeleri	670
1.2.2	Tehlike sembolleri	670
1.2.3	İkaz bilgilerinin yapısı	671
1.2.4	Genel semboller	671
A	Güvenlik	672
2.1	Genel Güvenlik bilgileri	672
2.1.1	Tüm ev gereçleri	672
W	Ekipman ve yardım	673
W	Onarım	674
4.1	Kapı contasının değiştirilmesi	674
4.1.1	Kapı contasının çıkartılması	674
4.1.2	Kapı contasının takılması	674
4.2	Kapı tutamağının değiştirilmesi	677
4.2.1	Kapı tutamağının çıkartılması	677
4.2.2	Kapı tutamağının takılması	677
4.3	Kapının üst menteşesinin değiştirilmesi	678
4.3.1	Kapının üst menteşesinin çıkartılması	678
4.3.2	Kapının üst menteşesinin takılması	679
4.4	Kapının üst menteşesinin değiştirilmesi (göstergeli kapı)	680
4.4.1	Kapının üst menteşesinin çıkartılması	680
4.4.2	Kapının üst menteşesinin takılması	681
4.5	Kapının orta menteşesinin değiştirilmesi	682
4.5.1	Kapının orta menteşesinin çıkartılması	682
4.5.2	Kapının orta menteşesinin takılması	682
4.6	Kapının alt menteşesinin değiştirilmesi	683
4.6.1	Kapının alt menteşesinin çıkartılması	683
4.6.2	Kapının alt menteşesinin takılması	683
4.7	Raf yüzeyinin değiştirilmesi	684
4.7.1	Raf yüzeyinin çıkartılması	684
4.7.2	Raf yüzeyinin takılması	684

4.8	Şişe rafının değiştirilmesi	685
4.8.1	Şişe rafının çıkartılması	685
4.8.2	Şişe rafının takılması	685
4.9	Kapı rafının değiştirilmesi	686
4.9.1	Kapı rafının çıkartılması	686
4.9.2	Kapı rafının takılması	686
4.10	Ayarlanabilir kapı rafının değiştirilmesi	687
4.10.1	Ayarlanabilir kapı rafının çıkartılması	687
4.10.2	Ayarlanabilir kapı rafının takılması	687
4.11	Dondurulacak gıda kabının değiştirilmesi	688
4.11.1	Dondurulacak gıda kabının çıkartılması	688
4.11.2	Dondurulacak gıda kabının takılması	688
4.12	Kabın değiştirilmesi	689
4.12.1	Kabın çıkartılması	689
4.12.2	Kabın takılması	689
4.13	Uzatılabilir kabın değiştirilmesi	690
4.13.1	Uzatılabilir kabın çıkartılması	690
4.13.2	Uzatılabilir kabın takılması	690
4.14	LED spot ışığının değiştirilmesi	691
4.14.1	LED spot ışığının çıkartılması	691
4.14.2	LED spot ışığının takılması	691
4.15	LED Üst aydınlatmanın değiştirilmesi	692
4.15.1	LED Lambanın sökülmesi	692
4.15.2	Üst LED ışığının takılması	693
4.16	LED yan çubuk ışığının değiştirilmesi	694
4.16.1	LED yan çubuk ışığının çıkartılması	694
4.16.2	LED yan çubuk ışığının takılması	695
4.17	LED spot ışığının değiştirilmesi	696
4.17.1	LED spot ışığının çıkartılması	696
4.17.2	LED spot ışığının takılması	697

i Bu doküman hakkında

1.1 Önemli bilgi

1.1.1 Amacı

Bu onarım ipuçları, tüketicinin cihazları, geçerli eko-tasarım yönetmeliğine göre (03/2021 itibarıyla) kendi başına onarması için destek sunar.

İpuçları, tanımlanmış yedek parçaların nasıl değiştirilmesi gerektiğine dair bilgiler, uyarılar ve söz konusu riskleri içerir.

Sorularınız varsa, lütfen yetkili servisimizle irtibata geçiniz. Yalnızca onarım ipuçlarına gerektiği gibi uyulduğu takdirde hasarlar için sorumluluk üstleniriz.

1.2 Sembollerinin açıklaması

1.2.1 Tehlike kademeleri

Tehlike kademeleri bir sembolden ve bir sinyal kelimesinden oluşur. Sinyal kelimesi tehlikenin şiddetini ve önemini tanımlar.





Tehlike kademesi	Anlamı
 TEHLİKE	İkaz bilgisinin dikkate alınmaması ölüme veya ağır yaralanmalara sebep olur.
 UYARI	İkaz bilgisinin dikkate alınmaması ölüme veya ağır yaralanmalara sebep olabilir.
 DİKKAT	İkaz bilgisinin dikkate alınmaması hafif yaralanmalara sebep olabilir.
DİKKATI	İkaz bilgisinin dikkate alınmaması maddi hasarların oluşmasına sebep olabilir.

Tablo 1: Tehlike kademeleri



1.2.2 Tehlike sembolleri

Tehlike sembolleri, tehlike türü hakkında bilgi veren anlamlı resimsel gösterimlerdir.

Bu dokümanda aşağıdaki tehlike sembolleri kullanılmıştır:

Tehlike sembolü	Anlamı
	Genel ikaz bilgisi
	Elektrik geriliminden kaynaklanan tehlike
	Patlamadan kaynaklanan tehlike
	Kesmeden dolayı yaralanma tehlikesi
	Sıkışıp ezilmeden dolayı yaralanma tehlikesi

i Bu doküman hakkında

Tehlike sembolü	Anlamı
	Sıcak yüzeylerden kaynaklanan tehlike
	Güçlü elektromanyetik alan tehlikesi
	İyonizasyon olmayan ışınlardan kaynaklanan tehlike

Tablo 2: Tehlike sembolleri

1.2.3 İkaz bilgilerinin yapısı

Bu dokümandaki ikaz bilgilerinin standart olarak görünüşü ve yapısı aynıdır.



	⚠ TEHLİKE Tehlikenin türü ve kaynağı!! Tehlike / ikaz bilgisinin dikkate alınmamasının sonucu. ► Tehlikeye karşı korunmak için yapılacak işlem ve yasaklar.
--	--







Aşağıdaki örnekte, gerilim ileten parçalar nedeniyle oluşabilecek elektrik çarpması tehlikesi hakkında uyarıda bulunan bir ikaz bilgisi gösterilmiştir. Tehlikeyi önlemek için alınması gereken önlemler belirtilmiştir.

	⚠ TEHLİKE Gerilim ileten parçalar nedeniyle elektrik çarpması tehlikesi!! Elektrik çarpması sebebiyle ölüm ► Onarıma başlamadan önce cihazın elektrik şebeke bağlantısını en az 60 saniye süreyle sökün.
--	---

1.2.4 Genel semboller

Bu dokümanda aşağıdaki genel semboller kullanılmıştır:

Genel sembol	Anlamı
	Özel ipucu işareti (metin ve/veya grafik)
	Basit ipucu işareti (yalnızca metin)
	Video linki işareti

Genel sembol	Anlamı
	Gerekli araçlar işareti
	Ön koşulların işareti
	Koşul işareti (... olursa olur)
	Sonuç işareti
	Tuş veya düğme işareti
	Malzeme numarası işareti
	Gösterilen yazı / ekran işareti (cihaz ekranındaki)

Tablo 3: Genel semboller

2.1 Genel Güvenlik bilgileri

2.1.1 Tüm ev gereçleri

Gerilim ileten parçalar nedeniyle elektrik çarpması tehlikesi!

- Elektrikli bileşenlerde yapılan onarımlarda hatalar, elektrik çarpmasına neden olabilir!
- Cihaz çalışmalara başlamadan en az 60 saniye önce elektrik şebekesinden ayrılmalıdır.
- Onarım sonrasında VDE 0701 veya ülkeye özel düzenlemeler uyarınca bir güvenlik testi gerçekleştirilmelidir.

Keskin kenarlar nedeniyle yaralanma tehlikesi!

- Koruyucu eldiven kullanılmalıdır.

Ağır ve hareketli parçaların onarım, bakım, hata arama ve servis işlemlerinde yaratabileceği ezilme riskleri

- Koruyucu ayakkabı giyin.
- Yere düşmemesi için ağır parçaları emniyete alın.
- Hareketli parçaların arasına gövde parçaları koymayın.





Cihaz güvenliğinde / fonksiyonda tehlike!

- Yalnızca orijinal parçalar kullanılmalıdır.

Elektrostatik hassasiyeti olan bileşenlerde hasar tehlikesi (ESD)!

- Bağlantılar ve iletken yolları da dahil olmak üzere modüllere dokunmayın.

Ekipman ve yardım

Tanımlama	Detaylar	Görüntüler
Koruyucu bez [00342013]	60 cm x 50 cm	
Düz tornavida	Bıçak 2,4 mm x 0,4 mm x 60 mm, [00341820] numaralı kit içinde	
Special tool [00342180]		
Vantuz [00342224]	Ø50 mm	
Torx Bit TX20 [00340865]	6,3 mm (1/4")	
Düz tornavida	Bıçak 10 mm x 1,6 mm x 200 mm	

4.1 Kapı contasının değiştirilmesi

Ön koşul:

- ✓ Kapı açık.

4.1.1 Kapı contasının çıkartılması

1. Kapı contasını sağ ve sol köşedeki oluklardan kurtarın.

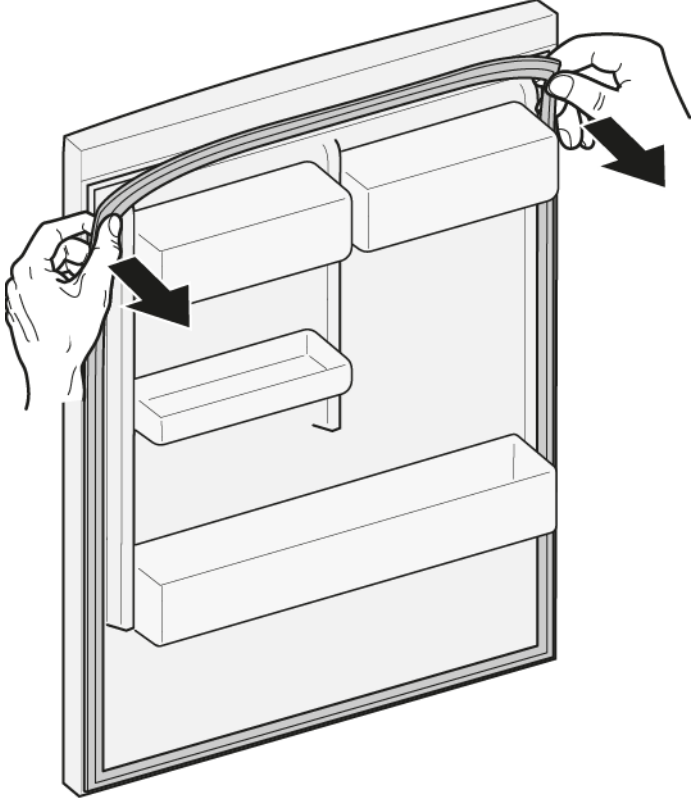

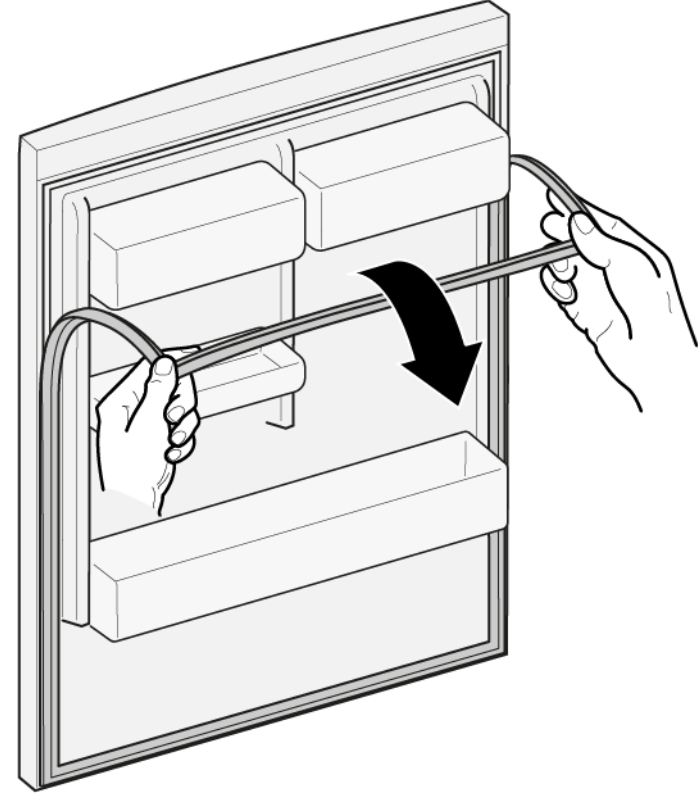

2. Kapı contasını oluktan dışarı çekin.



- ➡ Kapı contası çıkartılmıştır.

4.1.2 Kapı contasının takılması

	Yeni kapı contasının kalınlığı, eski kapı contasının kalınlığından biraz farklı olabilir. Bu, kapının kapanma özelliğini ve uzun süreli işlevini etkilemez.
	Cihazınızda ayarlanabilir menteşeler veya menteşe ekleri varsa, kapının kapanma özelliğini daha sonra optimize edebilirsiniz.
	Kapı contasındaki küçük yan delikler işlevseldir (havalandırma için gereklidir). Bunlar üretim hatası değildir.

1. Conta için oluğu hasar bakımından kontrol edin.

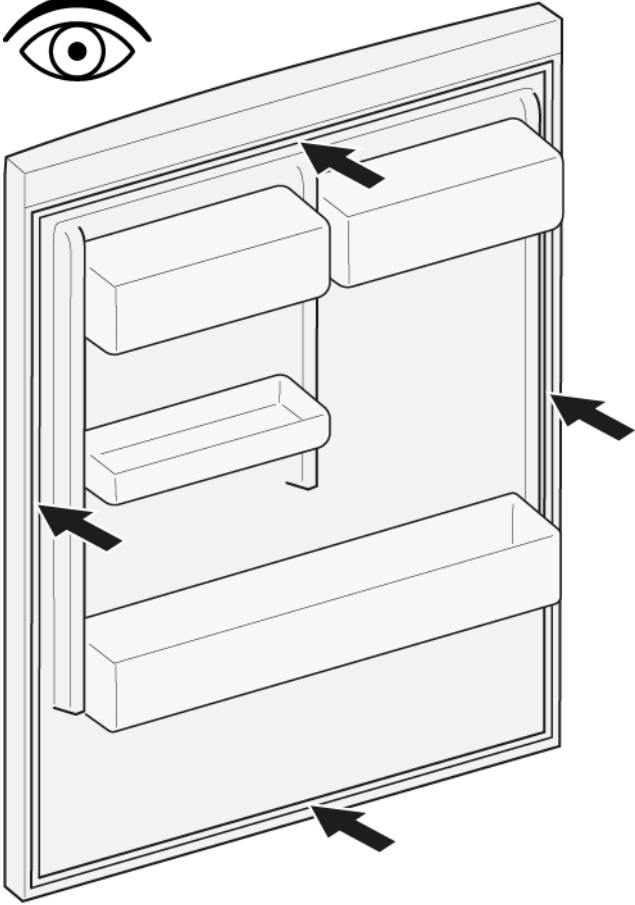

4. Contanın köşelerini üstten ve alttan oluğa itin.

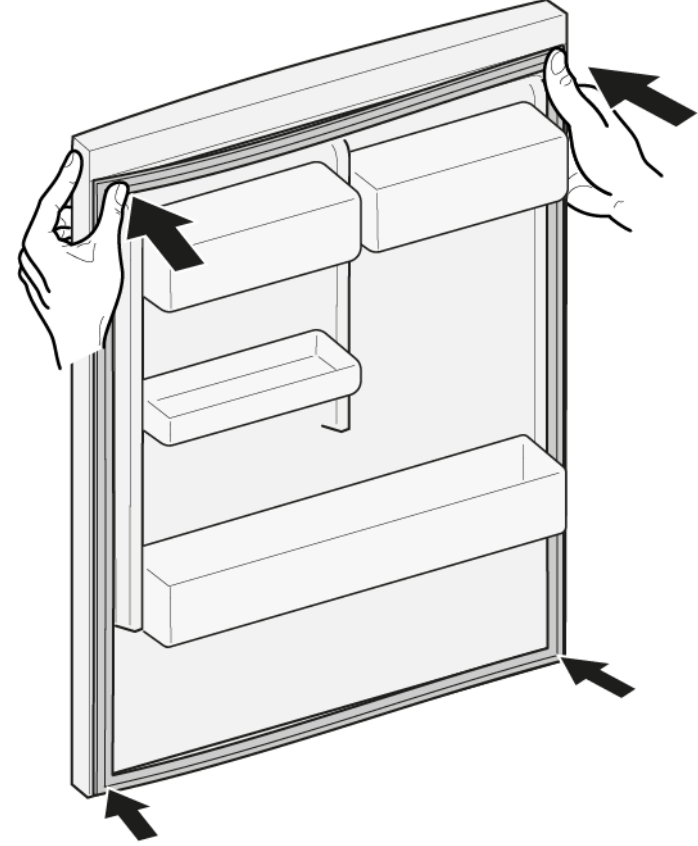



2.  Conta için oluk hasarlı ise,
- Müşteri hizmetleriyle irtibata geçin.

3.  Kapı contasında hafif deformasyon normaldir ve contanın işlevini etkilemez. Kapı contasını cihaza yerleştirmeden önce contanın düzleştirilmesi önerilir.

Kapı contasını bir saç kurutma makinesi veya sıcak suyla ısıtın ve manuel olarak şekillendirin.

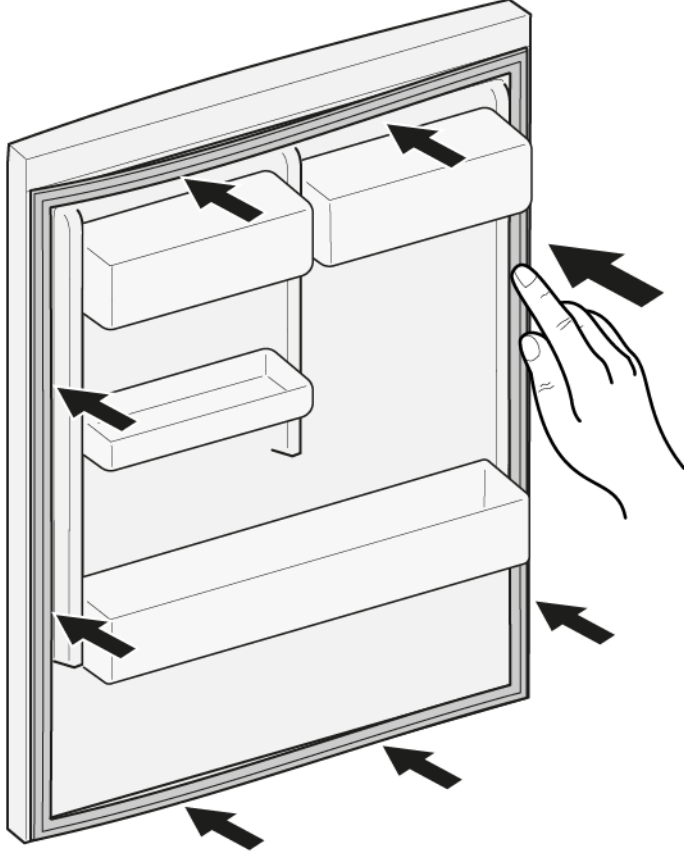
5. Contanın tamamını adım adım oluğun içine bastırın.



 Kapı contası takılmıştır.

4.2 Kapı tutamağının değiştirilmesi

Özel yardımcı ekipman:

- Torx Bit TX20 6,3 mm (1/4") [00340865]
- Düz tornavida Bıçak 10 mm x 1,6 mm x 200 mm

Ön koşul:

- ✓ Cihazın fişi çekilir.
- ✓ Kapı açık.

4.2.1 Kapı tutamağının çıkartılması

- 1. İki vidalı kapağı çıkartın (1).
- 2. Vidaları sökün (2).
- 3. Kapı tutamağını çıkartın (3).

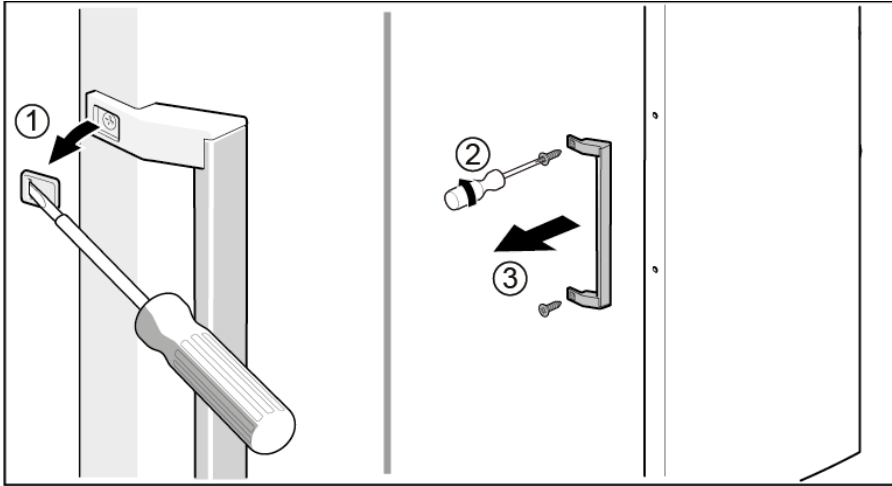

→ Kapı tutamağı çıkartılmıştır.



İkinci kapının tutamağı da aynı şekilde çıkartılabilir.

4.2.2 Kapı tutamağının takılması

- Ters sıra ile monte edin.



4.3 Kapının üst menteşesinin değiştirilmesi

Özel yardımcı ekipman:

Torx Bit TX20

6,3 mm (1/4")

[00340865]

	UYARI Ağır, büyük cihazlar! Sırt ve kas yaralanmaları <ul style="list-style-type: none">▶ Cihaz kapısını çıkarma işlemi sadece eğitimli uzmanlar tarafından gerçekleştirilmelidir.▶ Cihazı hareket ettirmek için iki kişi gereklidir.▶ Sadece uygun aletler ve ekipmanlar kullanın.
	DİKKAT Keskin köşeler! Kesik yaralanmaları <ul style="list-style-type: none">▶ Koruyucu eldiven kullanılmalıdır.
	UYARI Eğilmiş cihazların kayması! Kemik kırılmaları / çarpma sonucu yaralanmalar <ul style="list-style-type: none">▶ Cihazları kaymaya karşı emniyete alın.
	DİKKAT Vidaların gevşetilmesi nedeniyle parçaların düşme tehlikesi! Düşen parçalar nedeniyle yaralanma. <ul style="list-style-type: none">▶ Bileşenleri düşmeye karşı emniyete alın.
	DİKKAT! Vidaların gevşetilmesi nedeniyle parçaların düşme tehlikesi! Cihazın diğer parçalarında veya müşterinin evinde (örn. zemin) hasarlar. <ul style="list-style-type: none">▶ Bileşenleri düşmeye karşı emniyete alın.

Ön koşul:

- ✓ Cihazın fişi çekilir.
- ✓ Cihazın iç donanımları çıkartılmıştır.

4.3.1 Kapının üst menteşesinin çıkartılması

1. Cihazı arka tarafına yatırın.

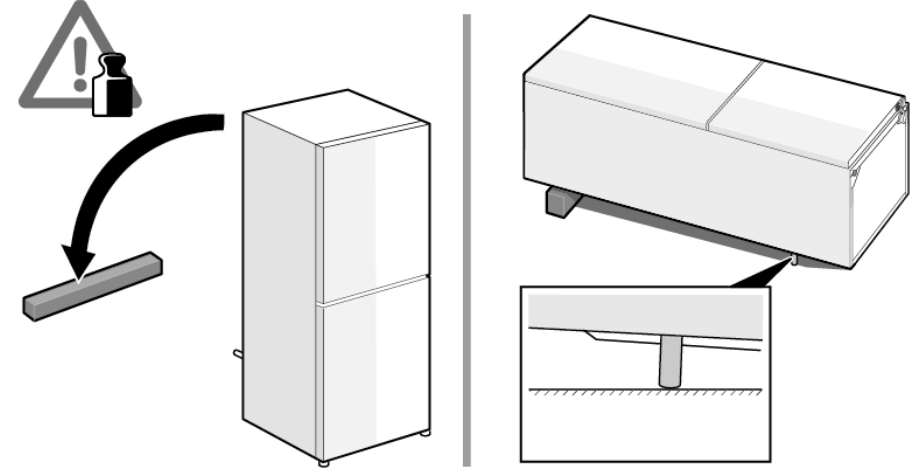

2. 1. Üst menteşe kapağını iki tarafta da bastırın (1).
2. Üst menteşe kapağını çıkartın (2).
3. Menteşe kapağını döndürün (3).
4. Üst menteşe kapağını sökün (4).
5. Vidaları sökün (5).
6. Üst menteşeyi çıkartın (6)/

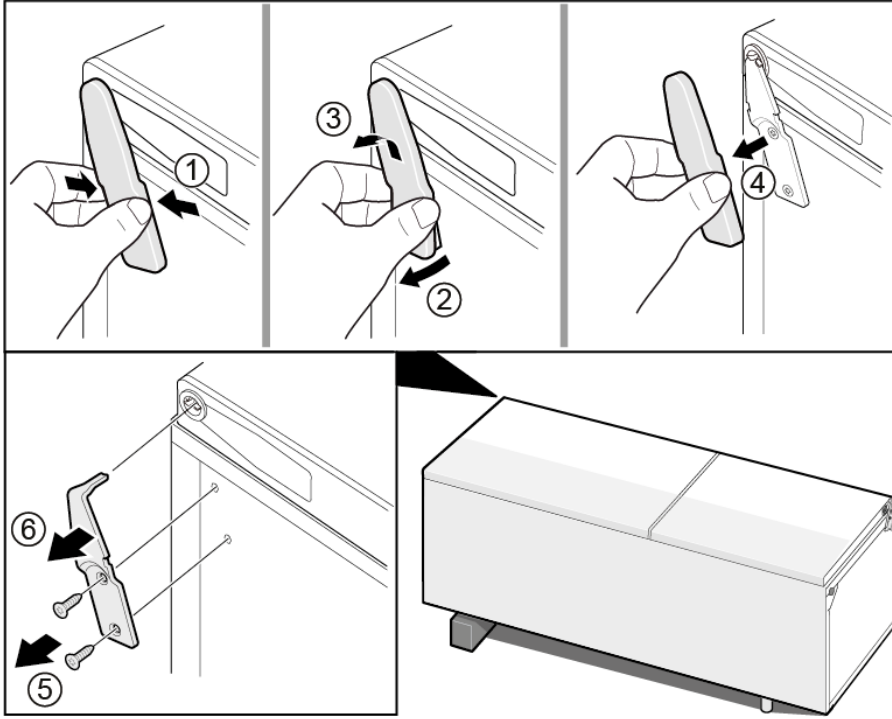

 Üst menteşe çıkarılır.

4.3.2 Kapının üst menteşesinin takılması

- ▶ Ters sıra ile monte edin.

4.4 Kapının üst menteşesinin değiştirilmesi (göstergeli kapı)

Özel yardımcı ekipman:

 Torx Bit TX20

6,3 mm (1/4")

[00340865]

	UYARI Ağır, büyük cihazlar! Sırt ve kas yaralanmaları ▶ Cihaz kapısını çıkarma işlemi sadece eğitimli uzmanlar tarafından gerçekleştirilmelidir. ▶ Cihazı hareket ettirmek için iki kişi gereklidir. ▶ Sadece uygun aletler ve ekipmanlar kullanın.
--	--

	DİKKAT Keskin köşeler! Kesik yaralanmaları ▶ Koruyucu eldiven kullanılmalıdır.
--	---

	UYARI Eğilmiş cihazların kayması! Kemik kırılmaları / çarpma sonucu yaralanmalar ▶ Cihazları kaymaya karşı emniyete alın.
--	--



	DİKKAT Vidaların gevşetilmesi nedeniyle parçaların düşme tehlikesi! Düşen parçalar nedeniyle yaralanma. ▶ Bileşenleri düşmeye karşı emniyete alın.
---	---

	DİKKAT! Vidaların gevşetilmesi nedeniyle parçaların düşme tehlikesi! Cihazın diğer parçalarında veya müşterinin evinde (örn. zemin) hasarlar. ▶ Bileşenleri düşmeye karşı emniyete alın.
--	---

	TEHLİKE Gerilim ileten parçalar nedeniyle elektrik çarpması tehlikesi!! Onarımın düzgün yapılmaması nedeniyle elektrik çarpması sonucu hayati tehlike ▶ Elektrikli parçaların onarımı kalifiye bir elektrik uzmanı tarafından gerçekleştirilmelidir. ▶ Onarım sonrasında VDE 0701 veya ülkeye özel düzenlemeler uyarınca bir güvenlik testi gerçekleştirilmelidir.
---	--

	TEHLİKE Gerilim ileten parçalar nedeniyle elektrik çarpması tehlikesi!! Elektrik çarpması sebebiyle ölüm ▶ Onarıma başlamadan önce cihazın elektrik şebeke bağlantısını en az 60 saniye süreyle sökün.
---	---

Ön kopul:

-  Cihazın fişi çekilir.
-  Cihazın iç donanımları çıkartılmıştır.

4.4.1 Kapının üst menteşesinin çıkartılması

1. Cihazı arka tarafına yatırın.

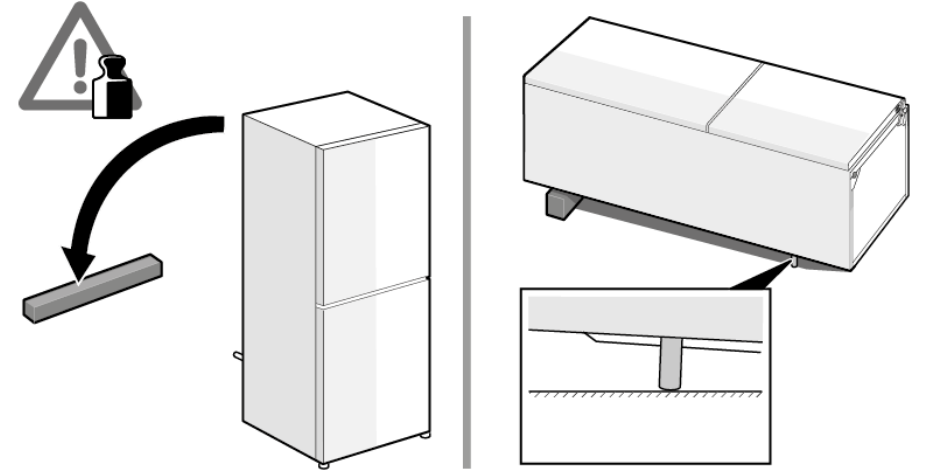

2. 1. Üst menteşe kapağını çıkartın (1).
2. Kablo kutusu kapağını çıkartın (2).
3. Elektrik bağlantısını ayırın (3)
4. Topraklama bağlantısı vidasını sökün (4).
5. Kablo korumasını çıkartın (5).
6. Vidayı sökün (6)

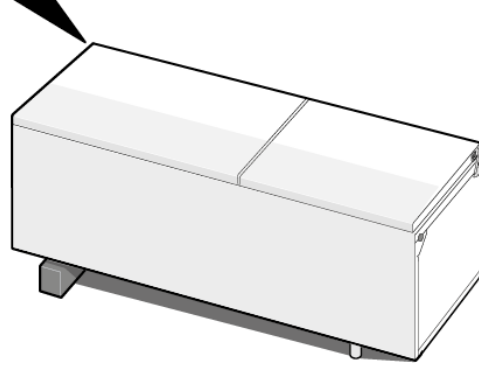
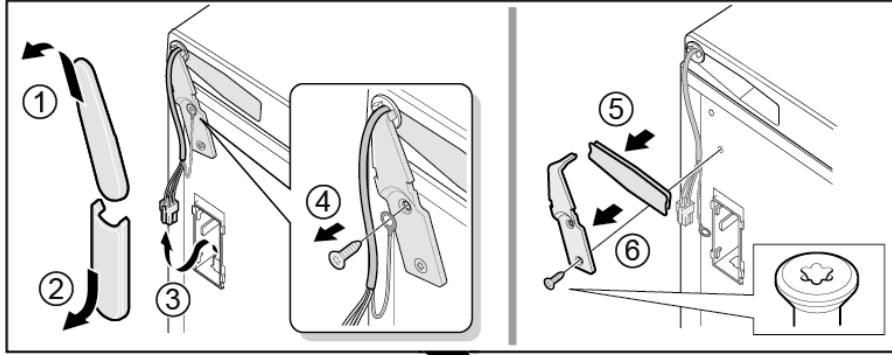

➔ Üst menteşe çıkarılır.

4.4.2 Kapının üst menteşesinin takılması

- ▶ Ters sıra ile monte edin.

4.5 Kapının orta menteşesinin değiştirilmesi

Özel yardımcı ekipman:

Torx Bit TX20

6,3 mm (1/4")

[00340865]



UYARI

Ağır, büyük cihazlar!

Sırt ve kas yaralanmaları

- ▶ Cihaz kapısını çıkarma işlemi sadece eğitimli uzmanlar tarafından gerçekleştirilmelidir.
- ▶ Cihazı hareket ettirmek için iki kişi gereklidir.
- ▶ Sadece uygun aletler ve ekipmanlar kullanın.



DİKKAT

Keskin köşeler!

Kesik yaralanmaları

- ▶ Koruyucu eldiven kullanılmalıdır.



UYARI

Eğilmiş cihazların kayması!

Kemik kırılmaları / çarpma sonucu yaralanmalar

- ▶ Cihazları kaymaya karşı emniyete alın.



DİKKAT

Vidaların gevşetilmesi nedeniyle parçaların düşme tehlikesi!

Düşen parçalar nedeniyle yaralanma.

- ▶ Bileşenleri düşmeye karşı emniyete alın.



DİKKAT!

Vidaların gevşetilmesi nedeniyle parçaların düşme tehlikesi!

Cihazın diğer parçalarında veya müşterinin evinde (örn. zemin) hasarlar.

- ▶ Bileşenleri düşmeye karşı emniyete alın.

Ön koşul:

- ✓ Cihazın fişi çekilir.
- ✓ Cihazın iç donanımları çıkartılmıştır.
- ✓ Kapının üst menteşesi çıkartılmıştır.

4.5.1 Kapının orta menteşesinin çıkartılması

- ▶ 1. Soğutucu bölüm kapısını sökün (1).
- ▶ 2. Vidaları sökün (2).
- ▶ 3. Orta menteşeyi çıkartın (3).

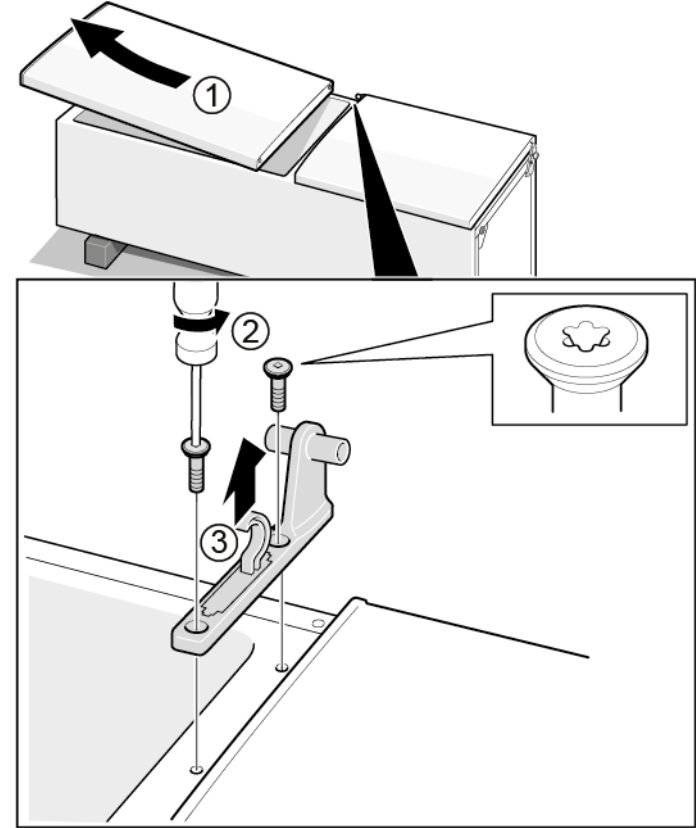

➡ Orta menteşe çıkartılmıştır.

4.5.2 Kapının orta menteşesinin takılması

- ▶ Ters sıra ile monte edin.

4.6 Kapının alt menteşesinin değiştirilmesi

Özel yardımcı ekipman:

Torx Bit TX20

6,3 mm (1/4")

[00340865]

	<p>UYARI</p> <p>Ağır, büyük cihazlar! Sırt ve kas yaralanmaları</p> <ul style="list-style-type: none">▶ Cihaz kapısını çıkarma işlemi sadece eğitimli uzmanlar tarafından gerçekleştirilmelidir.▶ Cihazı hareket ettirmek için iki kişi gereklidir.▶ Sadece uygun aletler ve ekipmanlar kullanın.
--	---

	<p>DİKKAT</p> <p>Keskin köşeler! Kesik yaralanmaları</p> <ul style="list-style-type: none">▶ Koruyucu eldiven kullanılmalıdır.
--	--

	<p>UYARI</p> <p>Eğilmiş cihazların kayması! Kemik kırılmaları / çarpma sonucu yaralanmalar</p> <ul style="list-style-type: none">▶ Cihazları kaymaya karşı emniyete alın.
--	---

	<p>DİKKAT</p> <p>Vidaların gevşetilmesi nedeniyle parçaların düşme tehlikesi! Düşen parçalar nedeniyle yaralanma.</p> <ul style="list-style-type: none">▶ Bileşenleri düşmeye karşı emniyete alın.
---	--

	<p>DİKKAT!</p> <p>Vidaların gevşetilmesi nedeniyle parçaların düşme tehlikesi! Cihazın diğer parçalarında veya müşterinin evinde (örn. zemin) hasarlar.</p> <ul style="list-style-type: none">▶ Bileşenleri düşmeye karşı emniyete alın.
--	--

Ön koşul:

- ✓ Cihazın fişi çekilir.
- ✓ Cihazın iç donanımları çıkartılmıştır.
- ✓ Üst menteşe çıkarılır.
- ✓ Orta menteşe çıkartılmıştır.

4.6.1 Kapının alt menteşesinin çıkartılması

- ▶ 1. Derin dondurucu bölmesi kapısını sökün (1).
- ▶ 2. Vidayı sökün (2).
- ▶ 3. Alt menteşeyi (3) çevirin.
- ▶ 4. Alt menteşeyi (4) çıkarın.

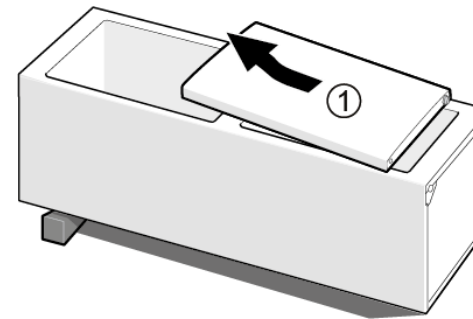
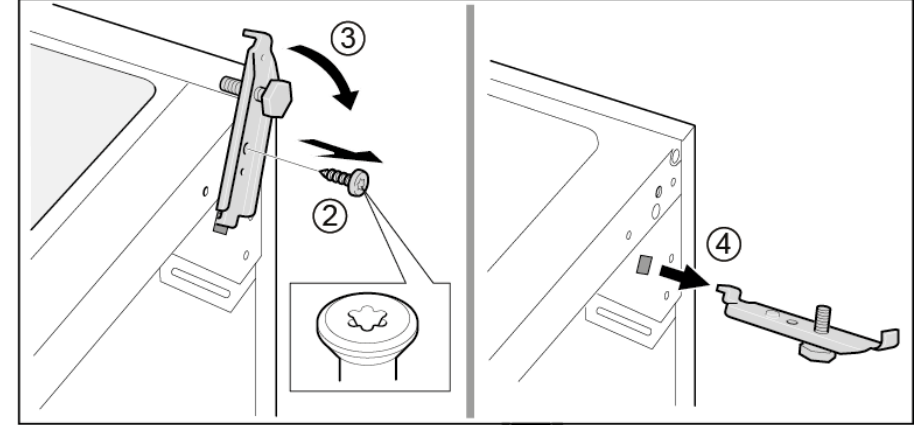

➡ Kapının alt menteşesi çıkartılmıştır.

4.6.2 Kapının alt menteşesinin takılması

- ▶ Ters sıra ile monte edin.

4.7 Raf yüzeyinin değiştirilmesi

Ön koşul:

- ✔ Kapı açık.

4.7.1 Raf yüzeyinin çıkartılması

- ▶ Raf yüzeyini dışarı çekin.

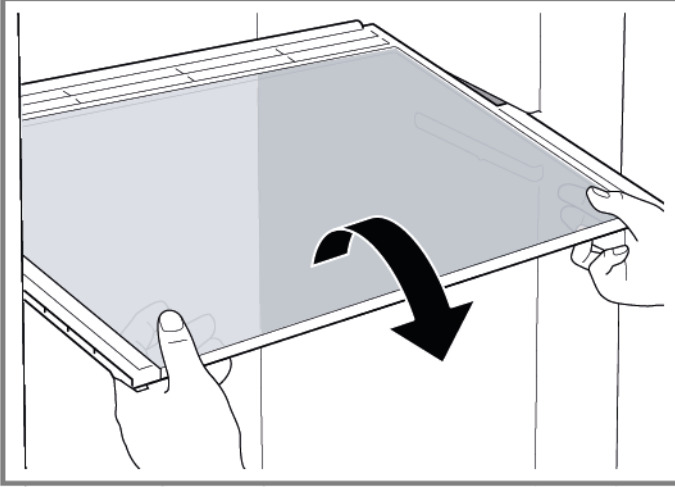

- ➡ Raf yüzeyi çıkartılmıştır.

4.7.2 Raf yüzeyinin takılması

- ▶ Ters sıra ile monte edin.

4.8 Şiše rafının değiştirilmesi

Ön koşul:

- ✔ Kapı açık.

4.8.1 Şiše rafının çıkartılması

- ▶ Şiše rafını dışarı çekin.

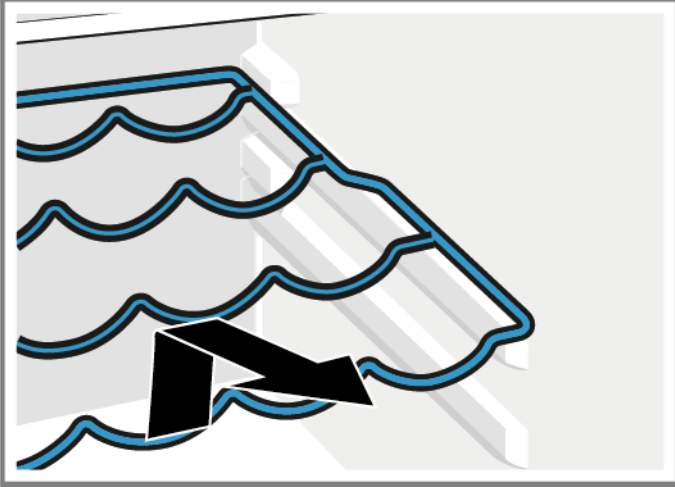

- ➡ Şiše rafı çıkartılmıştır.

4.8.2 Şiše rafının takılması

- ▶ Ters sıra ile monte edin.

4.9 Kapı rafının değiştirilmesi

Ön koşul:

- ✔ Kapı açık.

4.9.1 Kapı rafının çıkartılması

- ▶ Kapı rafını yukarıya doğru kaldırın.

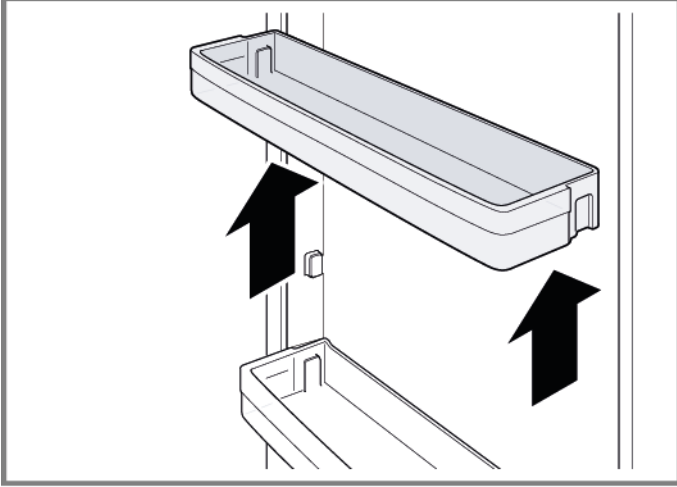

➡ Kapı rafı çıkartılmıştır.

4.9.2 Kapı rafının takılması

- ▶ Ters sıra ile monte edin.

4.10 Ayarlanabilir kapı rafının deęiřtirilmesi

Ön koşul:

- ✓ Kapı açık.

4.10.1 Ayarlanabilir kapı rafının çıkartılması

- ▶ Yüksek ayarlanabilir kapı rafını tutucudan çıkana dek yukarıya doğru hareket ettirin.

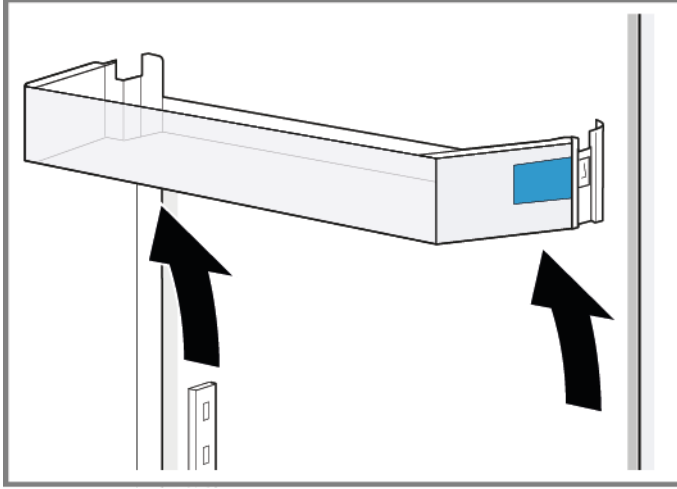

- ➡ Ayarlanabilir kapı rafı çıkartılmıştır.

4.10.2 Ayarlanabilir kapı rafının takılması

- ▶ Ters sıra ile monte edin.

4.11 Dondurulacak gıda kabının deęiřtirilmesi

Ön koşul:

- ✓ Kapı açık.

4.11.1 Dondurulacak gıda kabının çıkartılması

- ▶ 1. Dondurulacak gıda kabını tamamen dışarı çekin (1).
- ▶ 2. Gıda kabını çıkartın (2).

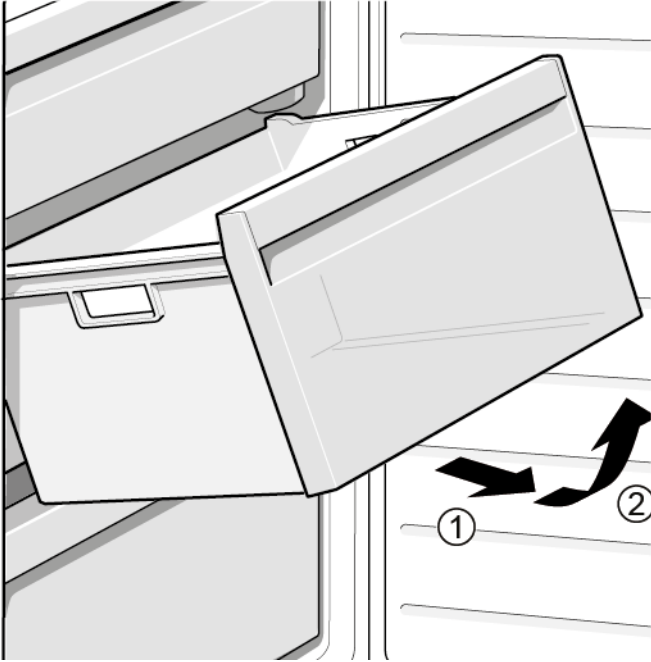

➡ Dondurulacak gıda kabı çıkartılmıştır.

4.11.2 Dondurulacak gıda kabının takılması

- ▶ Ters sıra ile monte edin.

4.12 Kabin deęiřtirilmesi

Ön koęul:

- ✓ Kapı açık.

4.12.1 Kabin çıkartılması

- ▶ 1. Alt buzdolabı kabını çıkartın (1).
- ▶ 2. Üst buzdolabı kabını çıkartın (2).

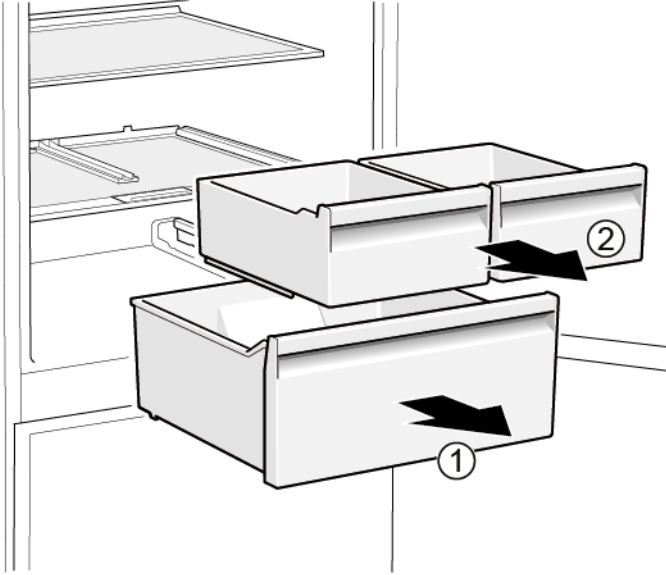

- ➡ Kapılar çıkartılmıştır.

4.12.2 Kabin takılması

- ▶ Ters sıra ile monte edin.

4.13 Uzatılabilir kabın deęiřtirilmesi

Ön koşul:

- ✓ Kapı açık.

4.13.1 Uzatılabilir kabın çıkartılması

- ▶ 1. Uzatılabilir kabı tamamen dışarı çekin (1).
- ▶ 2. Uzatılabilir kabı çıkartın (2).

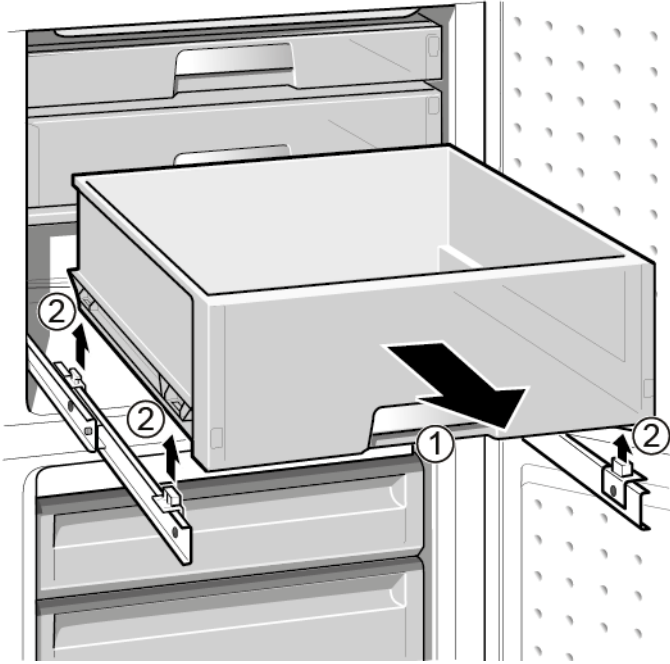

- ➡ Uzatılabilir kap çıkartılmıştır.

4.13.2 Uzatılabilir kabın takılması

- ▶ Ters sıra ile monte edin.

4.14 LED spot ışığının değiştirilmesi

Özel yardımcı ekipman:

Special tool

[00342180]

i Cihazınızda bakım gerektirmeyen bir LED ışık bulunmaktadır. Bu ışıklar sadece müşteri hizmetleri veya yetkili teknisyenler tarafından değiştirilebilir!

⚠ TEHLİKE
Gerilim ileten parçalar nedeniyle elektrik çarpması tehlikesi!!
Onarımın düzgün yapılmaması nedeniyle elektrik çarpması sonucu hayati tehlike

- ▶ Elektrikli parçaların onarımı kalifiye bir elektrik uzmanı tarafından gerçekleştirilmelidir.
- ▶ Onarım sonrasında VDE 0701 veya ülkeye özel düzenlemeler uyarınca bir güvenlik testi gerçekleştirilmelidir.

⚠ TEHLİKE
Gerilim ileten parçalar nedeniyle elektrik çarpması tehlikesi!!
Elektrik çarpması sebebiyle ölüm

- ▶ Onarıma başlamadan önce cihazın elektrik şebeke bağlantısını en az 60 saniye süreyle sökün.

⚠ DİKKAT
Keskin köşeler!
Kesik yaralanmaları

- ▶ Koruyucu eldiven kullanılmalıdır.

Ön koşul:

- ✓ Cihazın fişi çekilir.
- ✓ Kapı açık.

4.14.1 LED spot ışığının çıkartılması

1. LED spot ışığını dışarı çekmek için özel bir alet kullanın (1).



2. LED spot ışığının elektrik bağlantılarını ayırın.
- ➡ LED spot ışığı çıkartılmıştır.

4.14.2 LED spot ışığının takılması

- ▶ Ters sıra ile monte edin.

4.15 LED Üst aydınlatmanın değiştirilmesi

Özel yardımcı ekipman:

 Düz tornavida Bıçak 2,4 mm x 0,4 mm x 60 mm,
[00341820] numaralı kit içinde

 Cihazınızda bakım gerektirmeyen bir LED ışık bulunmaktadır. Bu ışıklar sadece müşteri hizmetleri veya yetkili teknisyenler tarafından değiştirilebilir!

 **TEHLİKE**
Gerilim ileten parçalar nedeniyle elektrik çarpması tehlikesi!!
Onarımın düzgün yapılmaması nedeniyle elektrik çarpması sonucu hayati tehlike

- ▶ Elektrikli parçaların onarımı kalifiye bir elektrik uzmanı tarafından gerçekleştirilmelidir.
- ▶ Onarım sonrasında VDE 0701 veya ülkeye özel düzenlemeler uyarınca bir güvenlik testi gerçekleştirilmelidir.



 **TEHLİKE**
Gerilim ileten parçalar nedeniyle elektrik çarpması tehlikesi!!
Elektrik çarpması sebebiyle ölüm

- ▶ Onarıma başlamadan önce cihazın elektrik şebeke bağlantısını en az 60 saniye süreyle sökün.

 **DİKKAT**
Keskin köşeler!
Kesik yaralanmaları

- ▶ Koruyucu eldiven kullanılmalıdır.

Ön koşul:

-  Cihazın fişi çekilir.
-  Kapı açık.
-  Üst iç donanımlar çıkartılmıştır.

4.15.1 LED Lambanın sökülmesi

1. LED Lambayı sol tarafa kaydırın.

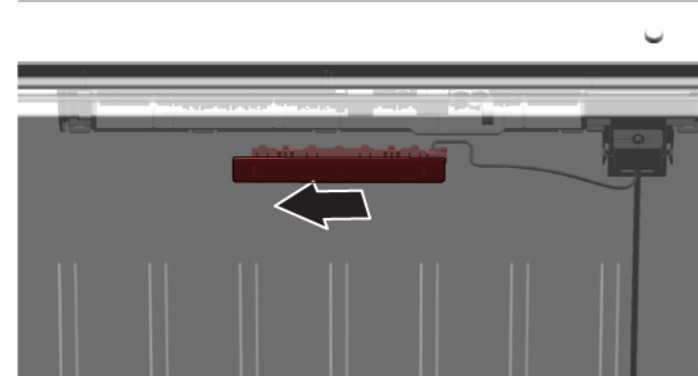

-  LED ışığının elektrik bağlantısı ayrıldı.

2. LED ışığını tırnaklarından kurtarın.

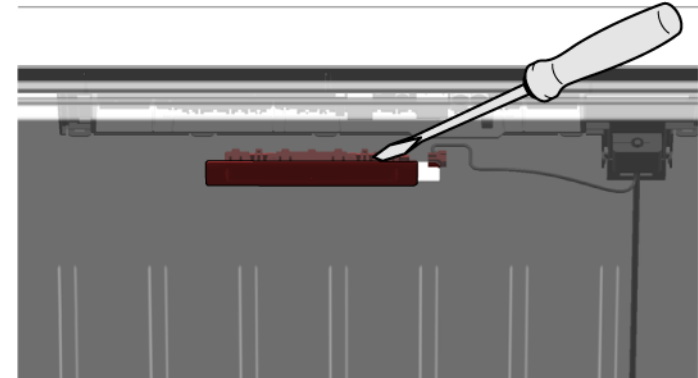

3. LED ışığını ileri hareket ettirerek sökün.

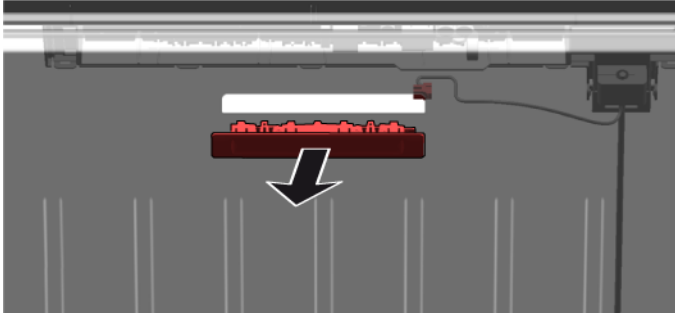

 LED ışığı söküldü.

4.15.2 Üst LED ışığının takılması

► Ters sıra ile monte edin.

4.16 LED yan çubuk ışığının değiştirilmesi

Özel yardımcı ekipman:

 Vantuz Ø50 mm [00342224]

 Cihazınızda bakım gerektirmeyen bir LED ışık bulunmaktadır. Bu ışıklar sadece müşteri hizmetleri veya yetkili teknisyenler tarafından değiştirilebilir!

 **TEHLİKE**
Gerilim ileten parçalar nedeniyle elektrik çarpması tehlikesi!!
Onarımın düzgün yapılmaması nedeniyle elektrik çarpması sonucu hayati tehlike

- ▶ Elektrikli parçaların onarımı kalifiye bir elektrik uzmanı tarafından gerçekleştirilmelidir.
- ▶ Onarım sonrasında VDE 0701 veya ülkeye özel düzenlemeler uyarınca bir güvenlik testi gerçekleştirilmelidir.



 **TEHLİKE**
Gerilim ileten parçalar nedeniyle elektrik çarpması tehlikesi!!
Elektrik çarpması sebebiyle ölüm

- ▶ Onarıma başlamadan önce cihazın elektrik şebeke bağlantısını en az 60 saniye süreyle sökün.

 **DİKKAT**
Keskin köşeler!
Kesik yaralanmaları

- ▶ Koruyucu eldiven kullanılmalıdır.

Ön koşul:

-  Cihazın fişi çekilir.
-  Kapı açık.
-  Soğutucu bölüm rafları çıkartılmıştır.

4.16.1 LED yan çubuk ışığının çıkartılması

1. Emme kabını LED yan çubuk ışığının üst üçte birlik kısmına yapıştırın.



- Emme kabını LED yan çubuk ışığı ile birlikte döndürme hareketi uygulayarak öne doğru çekin.

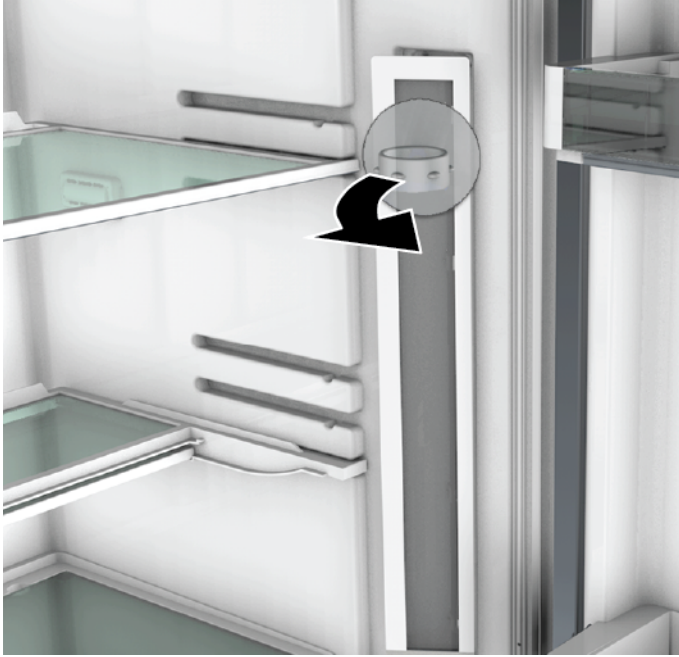

- LED yan çubuk ışığının elektrik bağlantısını ayırın.
➡ LED yan çubuk ışığı çıkartılmıştır.

4.16.2 LED yan çubuk ışığının takılması

- LED yan çubuk ışığının elektrik bağlantısını kurun.
 - LED yan çubuk ışığını, bölme panelinde yerine sabitleyin (kancalar yerine oturur).
- ➡ LED yan çubuk ışığının takılmıştır.

4.17 LED spot ışığının değiştirilmesi

Özel yardımcı ekipman:

- Special tool [00342180]
- Düz tornavida Bıçak 2,4 mm x 0,4 mm x 60 mm, [00341820] numaralı kit içinde

i Cihazınızda bakım gerektirmeyen bir LED ışık bulunmaktadır. Bu ışıklar sadece müşteri hizmetleri veya yetkili teknisyenler tarafından değiştirilebilir!

! TEHLİKE
Gerilim ileten parçalar nedeniyle elektrik çarpması tehlikesi!!
Onarımın düzgün yapılmaması nedeniyle elektrik çarpması sonucu hayati tehlike

- ▶ Elektrikli parçaların onarımı kalifiye bir elektrik uzmanı tarafından gerçekleştirilmelidir.
- ▶ Onarım sonrasında VDE 0701 veya ülkeye özel düzenlemeler uyarınca bir güvenlik testi gerçekleştirilmelidir.

! TEHLİKE
Gerilim ileten parçalar nedeniyle elektrik çarpması tehlikesi!!
Elektrik çarpması sebebiyle ölüm

- ▶ Onarıma başlamadan önce cihazın elektrik şebeke bağlantısını en az 60 saniye süreyle sökün.

! DİKKAT
Keskin köşeler!
Kesik yaralanmaları

- ▶ Koruyucu eldiven kullanılmalıdır.

Ön koşul:

- ✓ Cihazın fişi çekilir.
- ✓ Kapı açık.
- ✓ Soğutucu bölüm rafları çıkartılmıştır.

4.17.1 LED spot ışığının çıkartılması

- LED yan ışık kapağını çıkartın.

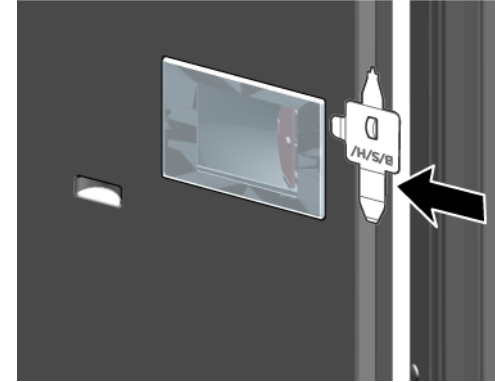

- LED spot ışığı kapağını içe doğru çekin ve aynı anda öne doğru itin.

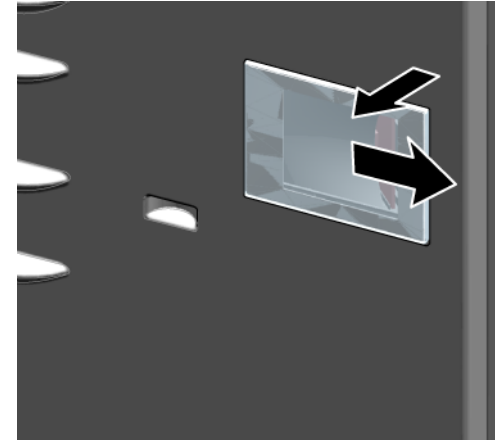

3. LED spot ışık modülünü ayırın.

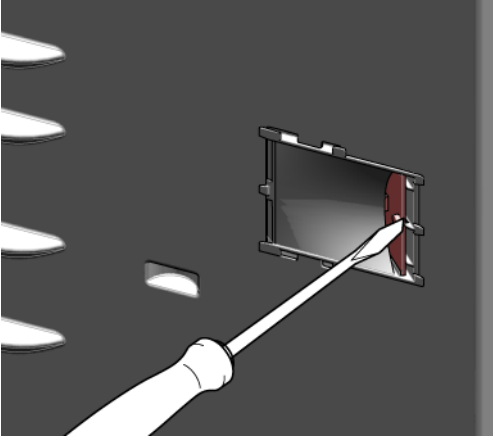

4. LED spot ışığının elektrik bağlantısını ayırın.

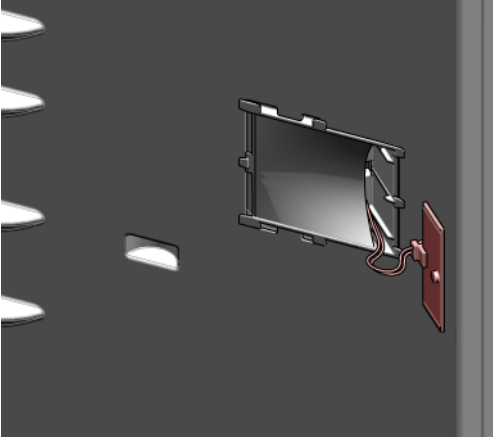

 LED spot ışığı çıkartılmıştır.

4.17.2 LED spot ışığının takılması

▶ Ters sıra ile monte edin.